



Power

P. 07
DMX³ ACB from
630 A to 6300 A
Fixed version

P. 08
DMX³ ACB from
630 A to 6300 A
Draw out version

P. 09
DMX³ ACB,
Protection Units,
Terminal Adapters
& Conversion Kits

P. 13
Auxillaries &
Accessories

P. 16
DRX MCCBs

P. 17-31
DPX³ MCCBs &
Accessories

P. 42-43 **NEW!**
E-Communicating
Infrastructure

P. 44 **NEW!**
Power Supply

P. 45-48 **NEW!**
EMDX³
Digital Meter

P. 62-63
MPX³ & MPX³
Accessories

P. 67
ALPX³ resin filled
capacitors standard
and heavy duty
440 V, 480 V & 525 V

P. 67
Alpican gas filled
capacitors
Heavy duty 440 V



**Protection,
Isolation,
Controlling,
Signalling,
Metering.**

P. 72-74
DX³ MCB
Isolator
RCDs

P. 76
DX³
Accessories
and Auxillaries

P. 77
DX³ RCD
add-on module
with metering

P. 81
Lexic dimmer and
Power contactors

P. 81
Lexic
Time delay
relay

P. 81
Time switches and
Accessories



**Distribution
Boards**

P. 85
Ekinox³
ETPN DBs

P. 85-86
Ekinox³
TPN DB-VTPN

P. 86
Ekinox³
TPN DB-Phase Selector

P. 88
Ekinox³
Cable end box,
Meter box, PPT Kit
& Accessories

P. 89
Ekinox³ DBs
Plexo 3 boxes for
DX³ and Accessories



**Arteor™
Wiring
Accessories**

P. 105
Switches, Push buttons,
Dimmers, Regulators,
Indian standard sockets
square white

P. 106
USB Chargers, Data & voice, Hotel
funtions, Audio Video, Energy
plugs, USB Charger, RJ11 Telephone
Sockets, Information outlets

P. 111-112
Switches, Push
buttons, Dimmers &
Regulators, Round
White Mechanism

P. 112
Switches,
Push buttons

P. 112
Dimmers &
Regulators
Round Magnesium
Mechanism

P. 120 **NEW!**
Arteor
TM Connected Home

P. 120 **NEW!**
White, Magnesium & Champagne Mechanism-
connected light switches, outlets, gateway pack,
wireless controls & wireless scene switches

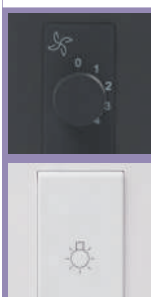

**Myrius™
Wiring
Accessories**

P. 128
Switches,
Push buttons, Sockets,
Power units and
Dimmer and regulators
White mechanisms

P. 129
ELU / Indicators,
Skirting light, Indicators,
Buzzers, Sensors and
Remote unit

P. 129
Hospitality
functions, Sockets
& connectors,
Data & voice

P. 131
Dimmer &
regulators, Switches,
Push buttons,
Black mechanisms

P. 132
ELU / Indicators,
Skirting light,
Indicators, Buzzers
& Sensor

P. 132
Remote unit,
Hospitality functions,
Sockets & connectors,
Data & voice

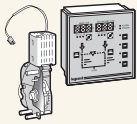

P. 10
Auxiliaries & Accessories

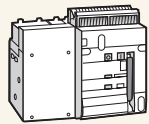

P. 12
DMX SP 2500 ACB
630 A to 2500 A
Fixed version
Draw-out version

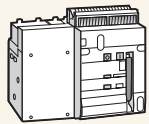

P. 12
DMX SP 2500 Switch
disconnectors 630 A
to 2500 A Fixed ver-
sion Draw-out version



P. 13
DMX SP 2500
Protection Units



P. 34-37 **NEW!**
DRX 250^{HP}
& 630
MCCBs & Accessories

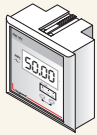

P. 49-52 **NEW!**
PMX
Digital Panel Meter

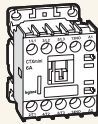

P. 54-56
CTX³
contactors

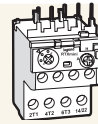

P. 57
RTX³
thermal relays

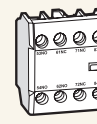

P. 59-60
CTX³
accessories



P. 67
Alpx³ box type
capacitors standard
and heavy duty
440 V



P. 68
Reactors and
power factor con-
trollers

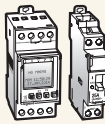

P. 77
DX³
Time switches
and Contactors

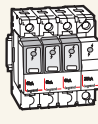

P. 78-79
SPD

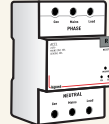

P. 81 **NEW!**
ACCL

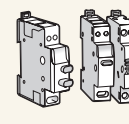

P. 81
DX³ changeover
switches,
Push buttons and
Indicators



P. 81
Time lag switches



P. 87
Ekinox³
TPN DB-
7 Segment DBs



P. 87
Ekinox³
P17 Tempra Plug
& Socket DBs



P. 87
Ekinox³ Metra
Plug & Socket
DBs



P. 88
Ekinox³
Metal
Enclosures



P. 107
Accessories
Square Mechanism

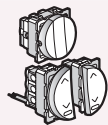

P. 108
Indian standard
sockets,
USB Chargers,
Data & voice

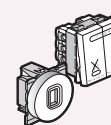

P. 108-110
Hotel Functions
Square Champagne
& Round White
Mechanism

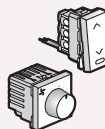

P. 112-113
Switches, Push
buttons, Dimmers &
Regulators, Plates
Round Champagne
Mechanism

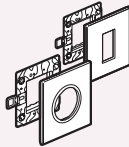

P. 113-117
Square cover plates,
Round cover plates

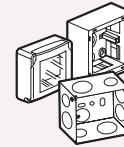

P. 117
Plastic surface,
Metal flush boxes,
Plexo boxes &
Accessories

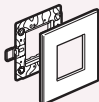

P. 120-123 **NEW!**
COVER PLATES
White, Pearl Aluminium, Graphite, Magnesium, Champagne, Dark Bronze, Mirror, Silver
Baroque, Dark Baroque, Metal, Wood & Signature cover with overmoulded frame



P. 123 **NEW!**
Cover plates without frame



P. 129
USB chargers
and Audio
& video connectors

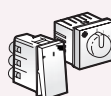

P. 129
Switches,
Push buttons,
Sockets,
Power units

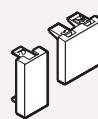

P. 130
Anti-Bacterial
Switches and
Accessories



P. 132
USB chargers
and Audio & video
connectors

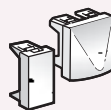

P. 132
Volume controller,
Protectors and
Accessories,
Modular MCBs

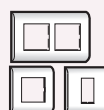

P. 132-133
White & Black
plastic plates

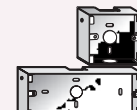

P. 133
Flush mounting &
Surface boxes



**Mylinc™
Wiring
Accessories**



P. 137
Mylinc switches,
Dimmers and
Accessories USB
charger and remote unit



P. 137
Mylinc energy
sockets, Power
units and MCBs

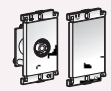

P. 137
Mylinc TV and RJ 11
telephone sockets
and Accessories



P. 138
Mylinc switches,
Dimmers, USB
charger, Remote unit
& Accessories

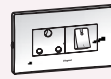

P.138-139
Mylinc energy
sockets,
Power units and
MCBs

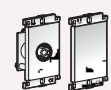

P. 139
Mylinc TV,
RJ 11 Telephone
Sockets &
Accessories



**Lyncus™
Wiring
Accessories**



P. 143
Switches,
Push buttons,
Indian Standard
Sockets



P.143
Dimmer and
regulators,
Hospitality
Functions



P.144
Data voice,
Pre terminated
audio video
connectors



P. 144-145
Switches,
Push buttons,
Dimmer and regulators,
Accessories



P.145
Hospitality
Functions,
Data voice,
Pre terminated



P. 145
Audio Video
Connectors, USB
chargers: Combi
Sockets + USB



**Britzy™
Wiring
Accessories**

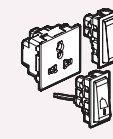

P. 149-150
Britzy Switches,
sockets and push
buttons

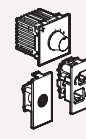

P. 149
Britzy Data & voice,
television sockets,
dimmers & regulators
& accessories



**Cable
Management
System and
Accessories**

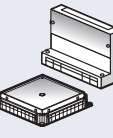

P. 154
Raceways & junction
boxes for screed
floors PVC, Metal
and Accessories

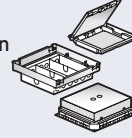

P. 154-155
Floor boxes for
raised floor, Screed
floor and tile/marble,
Support Plates

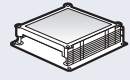

P. 155-158
Heavy Duty in-screed
floor box, Floor Boxes
3 module, Floor access
unit for raised floors



P. 165
Selection Chart:
DLP Mini Trunking
Systems



P. 166-167
Selection Chart :
DLP aluminium
Trunking system

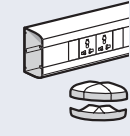

P. 168
Snap-On Trunking
45 mm, Routing
sections and
Accessories



**VDI
Structured
Cabling**

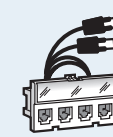

P. 173
LCS³,
cat. 8 Patch
Panels

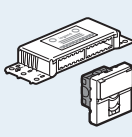

P. 173
LCS³,
cat. 8 Cables
and Cords

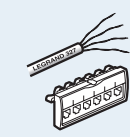

P. 173-179
LCS³,
cat. 6A Patch
panels, RJ 45,
Cables and Cords

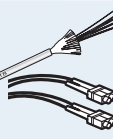

P. 184
LCS³,
Audio/Video
patch panel chord
cables

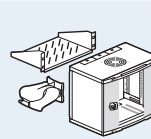

P. 184
Modular Panels
cassettes for LCS³
fibre optic drawers

P. 185
LCS³ pigtails, case
and quick-connect
connectors



**Movement
Detectors and
Door Phones**



P. 191
Movement
detectors



P. 191
Video door entry
system



**P17 Tempra Pro,
Hypra and
Plugs & Sockets**

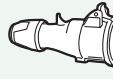

P. 198-199
P17 Tempra Pro
sockets

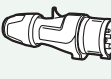

P. 198-199
P17 Tempra Pro
plugs

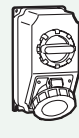

P. 198-199
P17 Tempra Pro
for refrigerated
container





P. 138
Mylinc
Modular Plates -
White



P. 139
Mylinc modular plates-
Matt Grey, Pearl white,
Champagne, Silver Alu,
Dark Bronze

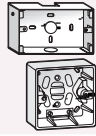

P. 140
Mylinc white
surrounds,
Flush & Surface
boxes



P. 144
USB Chargers:
Combi sockets + USB,
Wireless charger



P.144
sound diffusion
and loud speakers, Universal
dimmers, touch switches,
reading lights

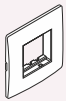

P. 146
Plate & Frame
Chic grey, Brushed
silver, Alu sunset,
Champagne, Matt silver

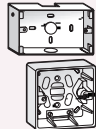

P. 146
Metal Flush box &
Plastic surface
boxes



P. 150 NEW!
Britzy white plate, warm orange
silver, herb beige, urban bronze,
orange chrome with frame

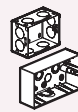

P. 151
Britzy Flush & sur-
face mounting boxes

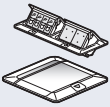

P. 158-159
Pop-up type flush-
mounting boxes,
Power & Data desk
grommets



P. 159
Flush Mounting
Power & data
module



P. 162-163
Selection Chart:
Snap-On trunking



P. 164-165
Selection chart:
DLP PVC
adaptable trunking
system

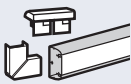

P. 168-169
DLP PVC Trunking
System, Trunking,
Mini-Trunking and
Accessories

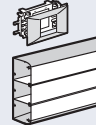

P. 170
DLP-S
PVC Trunking
system and Trunking
Accessories

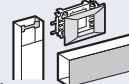

P. 170-170
DLP Aluminium
Adaptable Trunking
System, Aluminium
Snap-on columns

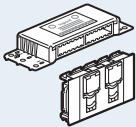

P. 180-182
LCS³,
cat. 6 Patch
Panels,,RJ 45,
Cables and Cords

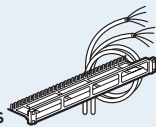

P. 180-182
LCS³,
cat. 5e Patch
panels, Cables
and Cords, RJ45

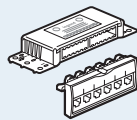

P. 182-183
LCS³,
cat. Splitter
sockets, adapters
and accessories



P. 183-184
LCS³, Audio/Video
Preterminated
sockets

P. 186-189
LCS³ High Density
and Very High
Density drawers
and cassettes

P. 188-189
LCS³
Preterminated
fibre optic and
cable solutions

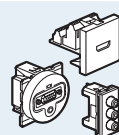

P. 189
9" fibre optic
drawers, LCS³
fibre optic blocks

P. 189
Patch chords



P. 200
Hypra industrial
plugs and sockets



DPX³

PRECISE PROTECTION
AND MEASUREMENT
UP TO 1600 A

TOTAL SELECTIVITY FOR OPTIMUM CONTINUITY OF SERVICE

DYNAMIC SELECTIVITY

Electronic DPX³ units have 2-position adjustment:

- Low for normal selectivity level
- High for high selectivity level

When electronic circuit breakers are set to High there is a slight tripping delay, enabling a high level of selectivity to be obtained, even for the highest short-circuit currents.

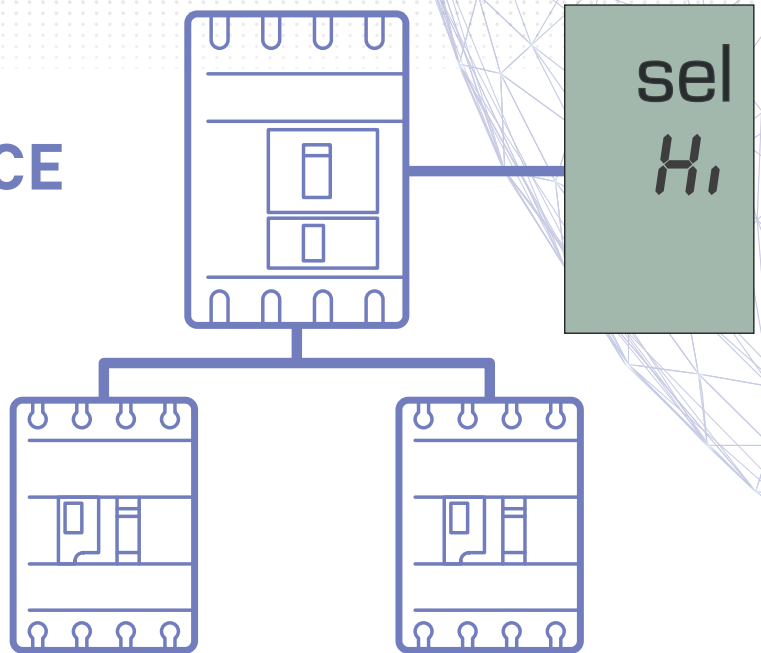

DPX³ 160



DPX³ 250



DPX³ 630



DPX³ 1600

DRX™ MCCB

Type and frame size	Rated Current (A)	Poles	Cat.Nos	MRP* ₹ / Unit	Pack
---------------------	-------------------	-------	---------	---------------	------

DRX MCCBs

DRX 100	63 A	3 Pole	0270 39	2604	1/12
Icu = 10 kA	75 A	3 Pole	0270 07	2604	1/12
	100 A	3 Pole	0270 08	2604	1/12
	63 A	4 Pole	0270 29	4072	1/12
	75 A	4 Pole	0270 17	4072	1/12
	100 A	4 Pole	0270 18	4072	1/12

Description	Cat.Nos	MRP* ₹ / Unit	Pack
-------------	---------	---------------	------

DIN rail adaptor

DRX 100	0271 87	416	1
---------	---------	-----	---

Rotary handles - Direct

DRX 100	6687 70	1310	1
---------	---------	------	---

Rotary handles - vary-depth

DRX 100	6687 71	2266	1
---------	---------	------	---

Padlocking support for operating handle

DRX 100	0271 80	138	1
---------	---------	-----	---

Connection accessories

Set of 2 shields for 3 pole	0271 81	98	1
-----------------------------	---------	----	---

Sealable terminal shields (moulded shrouds)

For DRX 100 - 3 pole	0271 83	1360	1
For DRX 100 - 4 pole	0271 84	1358	1

Cage terminals

For DRX 100 - 3 pole	0271 71	264	1
For DRX 100 - 4 pole	0271 73	278	1

Electrical accessories

Block with 1 auxiliary (1 AUX)	0271 40	864	1
Block with 1 alarm (1 AL)	0271 41	882	1
Block with 1 auxiliary + 1 alarm (1 AUX + 1 AL)	0271 42	1450	1

Current shunt coils

200/277 V~ and =	0271 54	1800	1
380/480 V~ and =	0271 55	1800	1

Undervoltage release coils

200/240 V~	0271 64	2086	1
380/415 V~	0271 65	2116	1

DRX spreader links

3 Links set for TP	6250 10	178	1
4 Links set for FP	6250 11	266	1

Metal one way enclosures for MCCB

Cat.Nos	Description	No. of modules	MRP* ₹ / Unit	Pack
5078 05	DRX 100 MCCB enclosure-TP	3	2090	1
5078 06	DRX 100 MCCB enclosure-FP	3	2130	1

* MRP - Maximum Retail Price Inclusive of all taxes including GST.

BUSBAR TRUNKING SYSTEM

FOR INDUSTRIAL, COMMERCIAL, RESIDENTIAL AND SERVICE SECTOR BUILDINGS

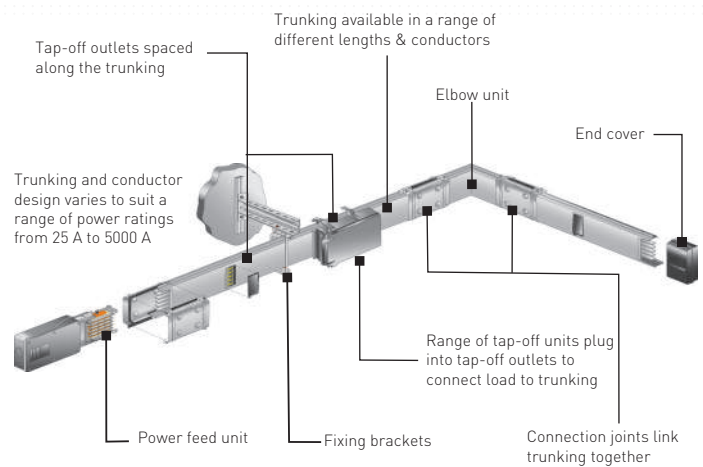

Exclusive features

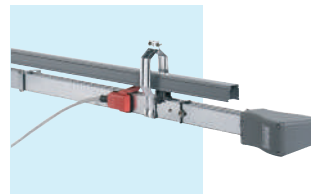

Low Power (25 A, 40 A, 63 A)

- Lighting busway
- 2, 4 & 6 pole
- IP 55 protection
- Tap off units at each 0.5 mt interval
- Copper busbars

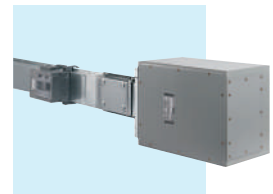

Medium Power (63 A - 1000 A)

- Riser mains application
- IP 40, IP 52, IP 55 protection
- Tap off units at each 1 mt interval
- Aluminium & copper busbars

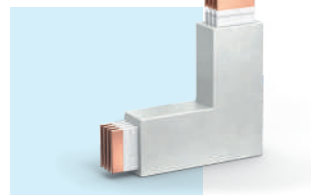

Cast Resin Busbar (630 A - 6300 A)

- Fully insulated with epoxy resin
- IP68 suited for outdoor
- Industrial plants, Petrochemical plants, Chemical plants in areas with risk of flooding.



Super Compact (630 A - 6300 A)

- Sandwich type construction
- IP 65 protection
- Tap off boxes at each 1 mt interval
- Aluminium & copper busbars

Bold Cat.Nos are products normally available with Legrand (India) Stockists. Cat.Nos that are not bold - delivery within 4 - 8 weeks from the date of order. **Bold packing quantity** is our mandatory packing. Orders to be placed by Legrand (India) Stockist in multiples of the same.

DPX³ MCCB

DPX³ MCCB with Thermal Magnetic Protection Unit

- Range: 16A – 1250A, Ics=100%Icu, Four Optimum Frames
 - Thermal Adjustable – 0.8 to 1In, Magnetic Adjustable** – 5 to 10In
 - Breaking Capacity# – 16kA, 25kA, 36kA, 50kA, 70kA & 100kA
 - Option for In built or add on module for Earth Leakage Protection##
 - Adjustable sensitivity: 0.03 - 0.3 - 1 - 3 A
 - Adjustable tripping: 0 - 0.3 - 1 - 3s
 - Suitable for Isolation
- ** Fixed at 10In for DPX³ 160
 # Refer Catalogue for frame wise data
 ## For DPX³ 160, DPX³ 250 and DPX³ 630 Only

Category	Type	Rated Current (A)	3P			4P		
			Cat.Nos	MRP*/₹/Unit	Pack	Cat.Nos	MRP*/₹/Unit	Pack

Thermal Magnetic : O/L & S/C protection

16 KA	DPX ³ 160	16	4200 00	6190	1	4200 10	8248	1
		25	4200 01	6190	1	4200 11	8248	1
		40	4200 02	6190	1	4200 12	8248	1
		63	4200 03	6190	1	4200 13	8248	1
		80	4200 04	6190	1	4200 14	8248	1
		100	4200 05	6190	1	4200 15	8248	1
		125	4200 06	6696	1	4200 16	8300	1
		160	4200 07	8550	1	4200 17	10764	1
25 KA	DPX ³ 160	16	4200 40	6642	1	4200 50	9234	1
		25	4200 41	6642	1	4200 51	9234	1
		40	4200 42	6642	1	4200 52	9234	1
		63	4200 43	6642	1	4200 53	9234	1
		80	4200 44	6642	1	4200 54	9234	1
		100	4200 45	6642	1	4200 55	9234	1
		125	4200 46	9612	1	4200 56	11664	1
		160	4200 47	12852	1	4200 57	14850	1
	DPX ³ 250	200	4202 08	18038	1	4202 18	21794	1
		250	4202 09	20910	1	4202 19	28176	1
36 KA	DPX ³ 160	16	4200 80	8648	1	4200 90	10638	1
		25	4200 81	8648	1	4200 91	10790	1
		40	4200 82	8648	1	4200 92	10790	1
		63	4200 83	8648	1	4200 93	10790	1
		80	4200 84	8648	1	4200 94	10790	1
		100	4200 85	8648	1	4200 95	10790	1
		125	4200 86	9720	1	4200 96	13230	1
		160	4200 87	13068	1	4200 97	14958	1
	DPX ³ 250	200	4202 38	22660	1	4202 48	30084	1
		250	4202 39	25148	1	4202 49	32218	1
	DPX ³ 630	320	4220 01	29396	1	4220 06	35054	1
		400	4220 02	29396	1	4220 07	35824	1
		500	4220 03	36366	1	4220 08	45416	1
		630	4220 04	36366	1	4220 09	46578	1
	DPX ³ 1600	800	4222 52	53710	1	4222 57	60426	1
		1000	4222 53	70106	1	4222 58	88626	1
		1250	4222 54	100172	1	4222 59	106620	1

■ Price available on request.

* MRP - Maximum Retail Price Inclusive of all taxes including GST.

Bold Cat.Nos are products normally available with Legrand (India) Stockists. Cat.Nos that are not bold - delivery within 4 - 8 weeks from the date of order. Bold packing quantity is our mandatory packing. Orders to be placed by Legrand (India) Stockist in multiples of the same.

DPX³ MCCB

Category	Type	Rated Current (A)	3P			4P		
			Cat.Nos	MRP*/₹/Unit	Pack	Cat.Nos	MRP*/₹/Unit	Pack

Only magnetic

16 KA	DPX ³ 160	16	4207 10	11918	1	-	-	-
		25	4207 11	11918	1	-	-	-
		50	4207 12	11918	1	-	-	-
		63	4207 13	11918	1	-	-	-
25 KA	DPX ³ 160	16	4207 14	13244	1	-	-	-
		25	4207 15	13244	1	-	-	-
		50	4207 16	13244	1	-	-	-
		63	4207 17	13244	1	-	-	-
36 KA	DPX ³ 250	100	4207 18	23130	1	-	-	-
		160	4207 19	23130	1	-	-	-
		200	4207 20	24456	1	-	-	-
		250	4207 21	25778	1	-	-	-
70 KA	DPX ³ 250	100	4207 22	■	1	-	-	-
		160	4207 23	■	1	-	-	-
		200	4207 24	■	1	-	-	-
		250	4207 25	■	1	-	-	-

Accessories

Type	Rotary handle				Shunt release											
	Direct		Vary depth		12 V		24 V		48 V		110 V		230 V		400 V	
	Cat.No	MRP	Cat.No	MRP	Cat.No	MRP	Cat.No	MRP	Cat.No	MRP	Cat.No	MRP	Cat.No	MRP	Cat.No	MRP
DPX ³ 160 DPX ³ 250	4201 60	1202	4201 61	1790	4210 12	2188	4210 13	2188	4210 14	2188	4210 15	2188	4210 16	2188	4210 17	2188
DPX ³ 630	4201 62	1924	4201 63	3398	-	-	4222 39	2310	4222 40	2310	4222 41	2310	4222 42	2310	4222 43	2310
DPX ³ 1600	0262 61	3748	0262 83	5746	-	-	-	-	-	-	-	-	-	-	-	-

Type	U/V release													
	12 V		24 V		48 V		110 V		230 V		400 V		480 V	
	Cat.No	MRP	Cat.No	MRP	Cat.No	MRP	Cat.No	MRP	Cat.No	MRP	Cat.No	MRP	Cat.No	MRP
DPX ³ 160 DPX ³ 250	4210 18	2486	4210 19	2486	4210 20	2486	4210 21	2462	4210 22	2462	4210 24	2462	4210 25	2462
DPX ³ 630 DPX ³ 1600	-	-	4222 45	2728	4222 46	2728	4222 47	2704	4222 48	2704	4222 49	2704	-	-

Type	Rated Current (A)	Spreaders**				Motor Operator									
		3P (Set of 3)		4P (Set of 4)		24-230V Side		24V		48V		110V		230V	
		Cat.No	MRP	Cat.No	MRP	Cat.No	MRP	Cat.No	MRP	Cat.No	MRP	Cat.No	MRP	Cat.No	MRP
DPX ³ 160		6250 02	420	6250 06	630	4210 60	30862	4210 61	27764	4210 61	27764	4210 61	27764	4210 61	27764
DPX ³ 250		6250 14	638	6250 18	848	-	-	-	-	-	-	-	-	-	-
DPX ³ 630		6250 04	1470	6250 08	1996	-	-	0261 40	57647	0261 41	57647	-	-	0261 44	44924
DPX ³ 1600	Upto 1250 A	4226 24	■	4226 25	■	-	-	0261 24	109844	0261 25	94781	0261 26	■	0261 23	52018
	Above 1600 A	0262 73	■	0262 74	■	-	-	0261 19	109844	0261 28	94781	0261 29	■	0261 27	52514

* MRP - Maximum Retail Price Inclusive of all taxes including GST.
 ■ Price available on request.

Bold Cat.Nos are products normally available with Legrand (India) Stockists. Cat.Nos that are not bold - delivery within 4 - 8 weeks from the date of order. Bold packing quantity is our mandatory packing. Orders to be placed by Legrand (India) Stockist in multiples of the same.

DPX³ 160 equipment and mounting accessories



4210 40

Cat.Nos	Description	MRP* ₹ / Unit	Pack
---------	-------------	------------------	------

Equipment for plug-in version

4210 40	For DPX ³ 160 - 3P	■	1
4210 41	For DPX ³ 160 - 4P	■	1
4210 44	Set of connectors for auxiliary contacts	■	1
4210 45	Key barrel and flat key for Padlocks	■	1
4210 46	Key barrel and star key for Padlocks	■	1
4210 47	Padlock accessory	■	1

Connection accessories

4210 26	Set of 3 terminals for High capacity cage terminals	7044	1
4210 27	Set of 4 terminals for High capacity cage terminals	9310	1
4210 70	Set of 3 insulated shields	156	1
4210 28	Set of 3 terminals Screw terminals for copper bars connection	800	1
4210 29	Set of 4 terminals Screw terminals for copper bars connection	956	1
6250 02	Set of 3 spreaders for DPX ³ 160 3P	420	1
6250 06	Set of 4 spreaders for DPX ³ 160 4P	630	1

Connection accessories

4210 36	Set of 3 rear terminals for DPX ³ 160 3P	3768	1
4210 37	Set of 4 rear terminals for DPX ³ 160 4P	5052	1

Sealable terminal shields

For front terminals

4210 54	For DPX ³ 160 3P	4112	1
4210 55	For DPX ³ 160 3P	4344	1

For rear terminals

4210 50	For DPX ³ 160 3P	2600	1
4210 51	For DPX ³ 160 4P	2312	1

Fixing plates

4210 71	For DPX ³ 160 3P / 4P without earth leakage module	380	1
4210 73	For DPX ³ 160 4P with earth leakage module	934	1
4210 68	For DPX ³ 160 3P / 4P with side mounting motor operator	956	1

■ Price available on request.

* MRP - Maximum Retail Price Inclusive of all taxes including GST.

MCCB Prices are without spreaders. For ordering spreaders refer page no. 21

DPX³ 160 and 250 common auxiliaries and accessories



4210 58

Cat.Nos	Description	MRP* ₹ / Unit	Pack
---------	-------------	------------------	------

Supply inverter type

4210 58	For fixed version	3472	1
4210 59	For plug-in and draw-out version	3700	1

Rotary handles

4201 60	Standard handle for thermal magnetic DPX ³	1202	1
4201 61	Vari-depth standard handles	1790	1
4201 67	Key Lock for VD RH DPX ³ 160 & 250	2110	1
4201 65	Key Lock for DIR RH Type A DPX ³ 160 & 250	2052	1
4201 68	Key Lock for VD RH Type A DPX ³ 160 & 250	2110	1
4201 66	Key Lock for DIR RH Type B DPX ³ 160 & 250	2052	1
4201 69	Key Lock for VD RH Type B DPX ³ 160 & 250	2110	1

Motor-driven handles

4210 60	Side motor operator	30862	1
4210 61	Front motor operator	27724	1
4210 62	Ronis key barrel for front motor operator	■	1
4210 63	Profalux key barrel for front motor operator	■	1

DPX³ 160 and 250 common auxiliaries and accessories

4210 64	Padlock for front motor operator	2148	1
4210 65	Ronis key barrel for side motor operator	16708	1
4210 66	Profalux key barrel for side motor operator	15180	1
4210 67	Padlock for side motor operator	2280	1

Auxiliary contacts

4210 10	1 N/C + 1 N/O auxiliary contact for rotary handles	1480	1
4210 11	Auxiliary contact or fault signalling contact	1156	1
4210 48	Signalling contact plugged-in/drawn-out (for DPX ³ plug-in version)	■	1

Locking accessory

4210 49	Padlock for locking in "open" position	1080	1
---------	----------------------------------------	------	---

Communication interface

4210 75	Modbus	23766	1
---------	--------	-------	---



4210 10



4210 11

Bold Cat.Nos are products normally available with Legrand (India) Stockists. Cat.Nos that are not bold - delivery within 4 - 8 weeks from the date of order. Bold packing quantity is our mandatory packing. Orders to be placed by Legrand (India) Stockist in multiples of the same.

DPX³ 250

equipment and mounting accessories

Cat.Nos	Description	MRP* ₹ / Unit	Pack
---------	-------------	------------------	------

Equipment for plug-in version

4210 42	For DPX ³ 250 - 3P	■	1
4210 43	For DPX ³ 250 - 4P with or without earth leakage module	■	1
4210 44	Set of connectors for auxiliary contacts	■	1
4210 45	Key barrel and flat key N° ABA90GEL6149 for Padlocks	■	1
4210 46	Key barrel and star key N° HBA90GPS6149 for Padlocks	■	1
4210 47	Padlock accessory	■	1

Connection accessories

4210 30	Set of 3 cage terminals	2840	1
4210 31	Set of 4 cage terminals	3698	1
4210 70	Set of 3 phase barriers	156	1

Connection accessories

6250 14	Set of 3 spreaders for DPX ³ 250 3P	638	1
6250 18	Set of 4 spreaders for DPX ³ 250 4P	848	1
4210 38	Set of 3 rear terminals for DPX ³ 250 3P	3806	1
4210 39	Set of 4 rear terminals for DPX ³ 250 4P	5124	1

Sealable terminal shields

For front terminals

4210 56	For DPX ³ 250 3P	4260	1
4210 57	For DPX ³ 250 4P	4510	1

For rear terminals

4210 52	For DPX ³ 250 3P	2542	1
4210 53	For DPX ³ 250 4P	2796	1

Fixing plates

4210 72	For DPX ³ 250 3P / 4P without earth leakage module	380	1
4210 74	For DPX ³ 250 4P with earth leakage module	1614	1
4210 69	For DPX ³ 250 3P / 4P with side mounting motor operator	942	1

■ Price available on request.

* MRP - Maximum Retail Price Inclusive of all taxes including GST.

MCCB Prices are without spreaders. For ordering spreaders refer page no. 21

DPX³ 630

equipment and accessories

Cat.Nos	Description	MRP* ₹ / Unit	Pack
---------	-------------	------------------	------

Plug-in version

4222 20	Set of incoming and outgoing terminals - 3P (6 terminals for 3P DPX ³ or 8 terminals for 4P DPX ³)	■	1
4222 21	Set of incoming and outgoing terminals - 4P (6 terminals for 3P DPX ³ or 8 terminals for 4P DPX ³)	■	1
4222 22	Front terminal mounting base for DPX ³ only - 3P	■	1
4222 24	Flat rear terminal mounting base for DPX ³ only - 3P	■	1
4222 23	Front terminal mounting base for DPX ³ only - 4P	■	1
4222 25	Flat rear terminal mounting base for DPX ³ only - 4P	■	1
4222 26	Front terminal mounting base for DPX ³ with earth leakage module - 4 P	■	1
4222 27	Flat rear terminal mounting base for DPX ³ with earth leakage module - 4P	■	1
4222 37	For fixing the signalling contact - 4P Cat.No 0265 74 on a DPX ³ plug-in version	■	1
4222 28	Set of 2 extractor handle	■	1
4222 29	Set of connectors (24-pin)	■	1

Draw-out version

4222 31	"Debro-lift" mechanism for DPX ³ base only - 3P	■	1
4222 32	"Debro-lift" mechanism for DPX ³ base only - 4P	■	1
4222 33	"Debro-lift" mechanism for DPX ³ base with elm - 4P	■	1
0265 76	One key for "Debro-lift" mechanism for DPX ³ only - Flat key	■	1
0265 78	Two keys (one key supplied) for "Debro-lift" mechanism for motorised DPX ³ or with rotary handle - Flat key	■	1
0263 48	One key for "Debro-lift" mechanism for DPX ³ only - Star key	■	1
0265 77	Two keys (one key supplied) for motorised DPX ³ or with rotary handle - Star key	■	1
0265 75	Handle for drawing-out for "Debro-lift" mechanism	■	1
0265 74	Signalling contact (plugged-in/drawn-out) for "Debro-lift" mechanism	■	1
4222 36	For fixing the signalling contact Cat.No 0265 74 on a DPX ³ draw-out version	■	1
4222 30	Block of 6 automatic auxiliary contacts for DPX ³ draw-out version (up to 2 blocks by DPX ³)	■	1

Bold Cat.Nos are products normally available with Legrand (India) Stockists. Cat.Nos that are not bold - delivery within 4 - 8 weeks from the date of order. Bold packing quantity is our mandatory packing. Orders to be placed by Legrand (India) Stockist in multiples of the same.

DPX³ 630 equipment and accessories

Cat.Nos	Description	MRP* ₹ / Unit	Pack
---------	-------------	------------------	------

Supply inverter type

0264 09	Plate for MCCB or trip-free switch fixed version	9016	1
0264 04	Plate for MCCB or trip-free switch plug-in and draw-out version	14036	1

Rotary handles

4201 62	Direct rotary handle	1924	1
4201 63	Vari-depth rotary handle	3398	1
4201 70	Key Lock for VD RH DPX ³ 630	2110	1
4201 71	Key Lock for VD RH Type A DPX ³ 630	2110	1
4201 72	Key Lock for VD RH Type B DPX ³ 630	2110	1

Motor-driven handles

0261 40	Front operated 24 V \sim /=	57647	1
0261 41	Front operated 48 V \sim /=	57647	1
0261 44	Front operated 230 V \sim	44924	1
0261 59	Lock and flat key	7110	1
0261 58	Lock and star key	14824	1

Accessories

0262 30	Set of 3 Insulated shields	186	1
0262 44	Set of 2 sealable terminal shields - 3P	5468	1
0262 45	Set of 2 sealable terminal shields - 4P	1566	1

Accessories

0262 40	Padlock for locking in "OPEN" position - 4P	1892	1
0262 46	Set of 4 adaptors + insulated shields for lug - 4P	7404	1
0262 47	Set of 4 extended front terminals - 4P	5540	1
6250 04	Set of incoming or outgoing spreaders - 3P	1470	1
6250 08	Set of incoming or outgoing spreaders - 4P	1996	1
0263 50	Set of incoming or outgoing swivel rear terminals - 3P	■	1
0263 52	Set of incoming or outgoing flat rear terminals - 3P	17896	1
0263 51	Set of incoming or outgoing swivel terminals - 4P	■	1
0263 53	Set of incoming or outgoing flat terminals - 4P	■	1
4222 34	Set of 2 IP 20 terminal covers - 3P	■	1
4222 35	Set of 2 IP 20 terminal covers - 4P	■	1



0261 40



6250 04



4222 34



4222 35

■ Price available on request.

* MRP - Maximum Retail Price Inclusive of all taxes including GST.

DPX³ 630 earth leakage module

Type and frame size	Rated Current (A)	Poles	Cat.Nos	MRP* ₹ / Unit	Pack
---------------------	-------------------	-------	---------	------------------	------

Earth Leakage Module

Standard

DPX ³ 630	400 A	3 Pole	0260 60	32626	1
	630 A	3 Pole	0260 64	57862	1
	400 A	4 Pole	0260 61	57266	1
	630 A	4 Pole	0260 65	60360	1

LED Version

DPX ³ 630	400 A	4 Pole	0260 63	■	1
	630 A	4 Pole	0260 67	■	1

DPX³ 1600 equipment and accessories

Cat.Nos	Description	MRP* ₹ / Unit	Pack
---------	-------------	------------------	------

Draw-out version

4225 86	Front terminals - 3P	■	1
4225 88	Rear terminals - 3P	■	1
4225 87	Front terminals - 4P	■	1
4225 89	Rear terminals - 4P	■	1
4225 93	Debro-lift mechanism For DPX ³ 1600 - 3P	■	1
4225 94	Debro-lift mechanism for DPX ³ 1600 - 4P	■	1
4225 95	For fixing the signalling contact	■	1
	Cat.No 0265 74 on a DPX ³ draw-out version		
0265 76	One key for "Debro-lift" mechanism for DPX ³ only - Flat key	■	1
0265 80	Two key (one key supplied) for motorised DPX ³ or with rotary handle	■	1
0263 48	One key for DPX ³ only - Starkey	■	1
0265 79	Two key (one key supplied) for motorised DPX ³ or with rotary handle	■	1
0265 75	Handle for drawing-out for "Debro-lift" mechanism	■	1
0265 74	Signalling contact (plugged-in/drawn-out)	■	1
4222 30	Block of 6 automatic auxiliary contacts for DPX ³ draw-out version (up to 2 blocks by DPX ³)	■	1



4225 88 + 4225 93

Bold Cat.Nos are products normally available with Legrand (India) Stockists. Cat.Nos that are not bold - delivery within 4 - 8 weeks from the date of order. Bold packing quantity is our mandatory packing. Orders to be placed by Legrand (India) Stockist in multiples of the same.

DPX³ 1600 equipment and accessories

Cat.Nos	Description	MRP* ₹ / Unit	Pack
---------	-------------	------------------	------

Supply inverter type

0264 10	Plate for MCCBs or trip-free switch fixed version	10854	1
0264 05	Plate for MCCBs or trip-free switch plug-in and draw-out version	24276	1

Rotary handles

0262 61	Standard (black) direct on DPX ³	3748	1
0262 83	Standard (black) vari-depth handle IP 55	5746	1
0262 93	Key barrel and flat key	2134	1
0262 94	Key barrel and star key	11772	1

Motor-driven handles

0261 54	Front operated 230 V~	75130	1
0261 24	Front operated 24 V~/= for In ≤ 1250 A	109844	1
0261 25	Front operated 48 V~/= for In ≤ 1250 A	94781	1

Motor-driven handles

0261 26	Front operated 110 V~/= for In ≤ 1250 A	■	1
0261 23	Front operated 230 V~/= for In ≤ 1250 A	52018	1
0261 19	Front operated 24 V~/= for In = 1600 A	109844	1
0261 28	Front operated 48 V~/= for In = 1600 A	94781	1
0261 29	Front operated 110 V~/= for In = 1600 A	■	1
0261 27	Front operated 230 V~/= for In = 1600 A	52514	1
0261 59	Key and flat key	7110	1
0261 58	Key and star key	14824	1

Accessories

0262 66	Set of 3 insulated shields	364	1
0262 64	Set of 2 sealable terminal shields - 3P	11105	1
0262 65	Set of 2 sealable terminal shields - 4P	2428	1
0262 60	Padlock for locking in "open" position	2086	1
0262 67	Set of 4 extended front short terminals for 630 - 1250 A (2 bars max. per pole)	13481	1



0262 60

- Price available on request.
- * MRP - Maximum Retail Price Inclusive of all taxes including GST.
- ◆ For Cat.Nos. and further details please contact th nearest branch.
- ▼ For communication add 4226 82 + 4226 89

DPX³ 630 and 1600 common auxiliaries

Cat.Nos	Description	MRP* ₹ / Unit	Pack
---------	-------------	------------------	------

Accessories

0262 68	Set of 4 extended front Long terminals for 1600 A (3 bars max. per pole)	20664	1
4226 24	Set of incoming or outgoing spreaders for 800 A & 1000 A - 3P	■	1
4226 25	Set of incoming or outgoing spreaders for 800 A & 1000 A - 4P	■	1
0262 73	Set of incoming or outgoing spreaders for 1250 A & 1600 A - 3P	■	1
0262 74	Set of incoming or outgoing spreaders for 1250 A & 1600 A - 4P	■	1
0263 80	Short rear terminals - 3P	■	1
0263 81	Long rear terminals - 3P	■	1
0263 82	Short rear terminals - 4P	■	1
0263 83	Long rear terminals - 4P	■	1
4225 90	Set of 2 IP 20 terminal covers - 3P	1528	1
4225 91	Set of 2 IP 20 terminal covers - 4P	2484	1
4225 92	External neutral - 4P	13460	1



0262 67
+
0262 68

Common auxiliaries

4210 11	For signalling the state of the contacts or opening of the MCCB on a fault For DPX ³ /DPX ³ -I Changeover switch 3 A - 240 V~	1070	1
---------	--------------------------------------------------------------------------------------------------------------------------------------------------------------	------	---

Releases

Allow remote tripping of a DPX³

Time-lag undervoltage releases (800 ms)

Prevent false tripping in the event of power supply microbreaks.

Require a time-lag module connected to the undervoltage release Cat.No 4226 23

0261 90	Time-lag module 230 V~ 3 module	19946	1
---------	------------------------------------	-------	---

Bold Cat.Nos are products normally available with Legrand (India) Stockists. Cat.Nos that are not bold - delivery within 4 - 8 weeks from the date of order. Bold packing quantity is our mandatory packing. Orders to be placed by Legrand (India) Stockist in multiples of the same.

DPX³ MCCB

Rotary handles for DPX³



- Smaller dimension of rotary handle base for better visibility of parameters and better access to trip unit
- Easy installation
- Spring for better play
- Door defeat mechanism for easy maintenance
- ON / OFF indication on the knob
- Pad Locking on the knob – upto 3 Locks

Cat.Nos	Description	MRP* ₹ / Unit	Pack
---------	-------------	------------------	------

Releases

0261 91	Time-lag module 400 V~	29140	1
4226 23	Undervoltage release for DPX3 630 and 1600	■	1

Auto Transfer Controller

4226 80	Standard unit	27612	1
4226 82	Advanced unit	30122	1
4226 89▼	Communication module	8074	1

Residual current relay

0260 88	Residual current relay to clip on module 2 rail	20540	1
---------	-------------------------------------------------	-------	---

Current Transformer

0260 92	Coil Ø35 mm	■	1
0260 93	Coil Ø80 mm	■	1
0260 94	Coil Ø110 mm	■	1
0260 95	Coil Ø140 mm	■	1
0260 96	Coil Ø210 mm	■	1
0260 97	Coil Ø150 mm - open	■	1
0260 98	Coil Ø300 mm - open	■	1

DPX³ ready-to-install ATS kit without MCCBs

6253 80*	Ready to use assembly for DPX ³ 160	244092	1
6253 81*	Ready to use assembly for DPX ³ 160 & DPX ³ 250	246334	1
6253 82*	Ready to use assembly for DPX ³ 250	306796	1
6253 87*	Ready to use assembly for DPX ³ 630	311482	1
6253 93	Kit assembly for ATS for DPX ³ 160	17190	1
6253 94	Kit assembly for ATS for DPX ³ 250	21702	1
6253 95	Kit assembly for ATS for DPX ³ 630	28474	1

Metal one way enclosures for MCCB

Cat.Nos	Description	No. of modules	MRP* ₹ / Unit	Pack
5078 01	DPX3 160 MCCB enclosure	3&4	3912	1
5078 02	DPX3 250 MCCB enclosure	3&4	6948	1
5078 04	DPX3 630 MCCB enclosure	3&4	10532	1

■ Price available on request.

* MRP - Maximum Retail Price Inclusive of all taxes including GST.

▼ For Cat.Nos. and further details please contact the nearest branch.

Bold Cat.Nos are products normally available with Legrand (India) Stockists. Cat.Nos that are not bold - delivery within 4 - 8 weeks from the date of order. Bold packing quantity is our mandatory packing. Orders to be placed by Legrand (India) Stockist in multiples of the same.



4226 82



0260 88



0260 93 coil for use with relay



0260 98



6253 93

DRX MCCB

DRX MCCB with Thermal Magnetic Protection Unit

NEW !

Range – 16A to 630A
 Ics = 100% Icu
 Thermal Adjustable – 0.8 to 1 In
 Magnetic Adjustable – 5 to 10 In starting from 50A
 Suitable for Isolation

Category	Type	Rated Current (A)	3P			4P		
			Cat.Nos	MRP*/₹/Unit	Pack	Cat.Nos	MRP*/₹/Unit	Pack

Thermal Magnetic : O/L & S/C protection

25 KA	DRX 250 ^{HP}	16	6690 00	■	1	6690 20	■	1
		20	6690 01	■	1	6690 21	■	1
		25	6690 02	■	1	6690 22	■	1
		32	6690 03	■	1	6690 23	■	1
		40	6690 04	■	1	6690 24	■	1
		50	6690 05	■	1	6690 25	■	1
		63	6690 06	■	1	6690 26	■	1
		80	6690 07	■	1	6690 27	■	1
		100	6690 08	■	1	6690 28	■	1
		125	6690 09	■	1	6690 29	■	1
		160	6690 10	■	1	6690 30	■	1
		200	6690 11	14806	1	6690 31	19426	1
250	6690 12	18008	1	6690 32	22050	1		
36 KA	DRX 250 ^{HP}	16	6690 40	■	1	6690 60	■	1
		20	6690 41	■	1	6690 61	■	1
		25	6690 42	■	1	6690 62	■	1
		32	6690 43	■	1	6690 63	■	1
		40	6690 44	■	1	6690 64	■	1
		50	6690 45	■	1	6690 65	■	1
		63	6690 46	■	1	6690 66	■	1
		80	6690 47	■	1	6690 67	■	1
		100	6690 48	■	1	6690 68	■	1
		125	6690 49	■	1	6690 69	■	1
		160	6690 50	■	1	6690 70	■	1
		200	6690 51	16276	1	6690 71	22732	1
		250	6690 52	19426	1	6690 72	23100	1
		DRX 630	320	6676 50	24592	1	6676 54	31376
400	6676 51		24592	1	6676 55	31376	1	
500	6676 52		29204	1	6676 56	36570	1	
630	6676 53		29204	1	6676 57	38160	1	

■ Price available on request.
 * MRP - Maximum Retail Price Inclusive of all taxes including GST.

Bold Cat.Nos are products normally available with Legrand (India) Stockists. Cat.Nos that are not bold - delivery within 4 - 8 weeks from the date of order. Bold packing quantity is our mandatory packing. Orders to be placed by Legrand (India) Stockist in multiples of the same.



6676 51

DRX MCCB

DRX MCCB with Thermal Magnetic Protection Unit

NEW!

Category	Type	Rated Current (A)	3P			4P		
			Cat.Nos	MRP*/₹/Unit	Pack	Cat.Nos	MRP*/₹/Unit	Pack

Thermal Magnetic : O/L & S/C protection

50 KA	DRX 250 ^{HP}	16	6690 80	■	1	6691 00	■	1
		20	6690 81	■	1	6691 01	■	1
		25	6690 82	■	1	6691 02	■	1
		32	6690 83	■	1	6691 03	■	1
		40	6690 84	■	1	6691 04	■	1
		50	6690 85	■	1	6691 05	■	1
		63	6690 86	■	1	6691 06	■	1
		80	6690 87	■	1	6691 07	■	1
		100	6690 88	■	1	6691 08	■	1
		125	6690 89	■	1	6691 09	■	1
		160	6690 90	■	1	6691 10	■	1
		200	6690 91	19006	1	6691 11	25726	1
		250	6690 92	20476	1	6691 12	26460	1
		DRX 630	320	6676 58	26818	1	6676 62	33444
400	6676 59		26818	1	6676 63	33444	1	
500	6676 60		31694	1	6676 64	39962	1	
630	6676 61		32860	1	6676 65	41446	1	



6690 92



6676 61

DRX MCCB

DRX MCCB with Electronic S2 (LSI) Protection Unit

- Range: 40A – 630A, Ics=100%Icu, Two Optimum Frames
- Protection against overloads:
 - Ir adjustable from 0.4 to 1 x In
 - tr adjustable from 3 to 30s#
- Protection against short circuits:
 - I_{sd} adjustable from 1.5 to 10 x Ir
 - t_{sd} adjustable from 0 to 0.5s
- Inbuilt Instantaneous Protection:
 - I_{i#} – Fixed
- Overload Alarm Indication - I > 1.05 Ir
- Pre-Overload Alarm Indication - I > 0.9 Ir
- Over temperature Alarm Indication - T > 90 °C
- Integrated Contact Module (On/Off/ Trip) for DRX 250HP Electronic MCCBs
- Suitable for Isolation

Category	Type	Rated Current (A)	3P			4P		
			Cat.Nos	MRP*/₹/Unit	Pack	Cat.Nos	MRP*/₹/Unit	Pack

Electronic S2

36 KA	DRX 250 ^{HP}	40	6691 70	14062	1	6691 80	19126	1
		100	6691 71	14062	1	6691 81	19126	1
		160	6691 72	18338	1	6691 82	25650	1
		250	6691 73	24582	1	6691 83	32062	1
	DRX 630	320	6699 01	31050	1	6699 06	38250	1
		400	6699 02	31050	1	6699 07	38250	1
		630	6699 04	34876	1	6699 09	45676	1

* MRP - Maximum Retail Price Inclusive of all taxes including GST.
 ■ Price available on request.

Bold Cat.Nos are products normally available with Legrand (India) Stockists. Cat.Nos that are not bold - delivery within 4 - 8 weeks from the date of order. Bold packing quantity is our mandatory packing. Orders to be placed by Legrand (India) Stockist in multiples of the same.

DRX MCCB

DRX MCCB with Electronic S2 (LSI) Protection Unit

Electronic S2

50 KA	DRX 250 ^{HP}	40	6691 90	17776	1	6692 00	23400	1
		100	6691 91	17776	1	6692 01	23400	1
		160	6691 92	24018	1	6692 02	32118	1
		250	6691 93	30656	1	6692 03	36000	1
	DRX 630	320	6699 11	33976	1	6699 16	43312	1
		400	6699 12	33976	1	6699 17	43312	1
630		6699 14	37688	1	6699 19	48262	1	

DRX MCCB

DRX MCCB with Electronic Sg (LSIg) Protection Unit

- Range: 40A – 630A, Ics=100%Icu, Two Optimum Frames
- Protection against overloads:
 - Ir adjustable from 0.4 to 1 x In
 - tr adjustable from 3 to 30s#
- Protection against short circuits:
 - I_{sd} adjustable from 1.5 to 10 x Ir
 - t_{sd} adjustable from 0 to 0.5s
- Inbuilt Instantaneous Protection:
 - Ii# – Fixed
- Protection against Ground Fault:
 - Ig adjustable from 0.2 to 1 In & OFF
 - tg adjustable from 0.1 to 1s
- Overload Alarm Indication - I > 1.05 Ir
- Pre-Overload Alarm Indication - I > 0.9 Ir
- Over temperature Alarm Indication - T > 90 °C
- Integrated Contact Module (On/Off/ Trip) for DRX 250HP Electronic MCCBs
- Suitable for Isolation

Category	Type	Rated Current (A)	3P			4P		
			Cat.Nos	MRP*/₹/Unit	Pack	Cat.Nos	MRP*/₹/Unit	Pack

Electronic Sg

36 KA	DRX 250 ^{HP}	40	6691 75	24188	1	6691 85	28126	1
		100	6691 76	24188	1	6691 86	28126	1
		160	6691 77	27562	1	6691 87	33750	1
		250	6691 78	32626	1	6691 88	40500	1
	DRX 630	320	6699 21	45226	1	6699 26	52032	1
		400	6699 22	45226	1	6699 27	52032	1
630		6699 24	48938	1	6699 29	60526	1	
50 KA	DRX 250 ^{HP}	40	6691 95	26438	1	6692 05	32062	1
		100	6691 96	26438	1	6692 06	32062	1
		160	6691 97	31500	1	6692 07	38250	1
		250	6691 98	35438	1	6692 08	42750	1
	DRX 630	320	6699 31	46800	1	6699 36	56476	1
		400	6699 32	46800	1	6699 37	56476	1
630		6699 34	50512	1	6699 39	63000	1	



6691 98

■ Price available on request.
 * MRP - Maximum Retail Price Inclusive of all taxes including GST.

Bold Cat.Nos are products normally available with Legrand (India) Stockists. Cat.Nos that are not bold - delivery within 4 - 8 weeks from the date of order. Bold packing quantity is our mandatory packing. Orders to be placed by Legrand (India) Stockist in multiples of the same.

DRX MCCB

DRX MCCB Accessories

NEW!



0271 54



0271 65



0271 40



0271 80

Frame	Accessory	CAT No.	MRP* ₹ / Unit	Pack
DRX 250 ^{HP}	Shunt - 230V AC	0271 54	1800	1
	Shunt - 415V AC	0271 55	1800	1
	UV Coil - 230V AC	0271 64	2086	1
	UV Coil - 415V AC	0271 65	2116	1
	Auxilliary Contact	0271 40	864	1
	Trip Alarm Contact	0271 41	882	1
	Auxilliary + Trip Common Block	0271 42	1450	1
	Padlock	0271 80	138	1
	Phase Barriers- 3P	6693 00	136	1
	Phase Barriers - 4P	6693 01	178	1
	Direct Handle	6687 72	1064	1
	Extended/ Vary Depth Handle	6687 73	1680	1
	Spreaders - 3P (set of 3)	6250 14	638	1
	Spreaders - 4P (Set of 4)	6250 18	848	1
	Direct handle random keylock - DRX 250 ^{HP}	6687 74	1870	1
	Direct handle Typ A keylock-DRX 250 ^{HP}	6687 75	1870	1
	Direct handle Typ B keylock-DRX 250 ^{HP}	6687 76	1870	1
	Vary depth handle random keylock-DRX 250 ^{HP}	6687 77	1836	1
	Vary depth handle type A keylock-DRX 250 ^{HP}	6687 78	1836	1
	Vary depth handle type B keylock-DRX 250 ^{HP}	6687 79	1836	1

* MRP - Maximum Retail Price Inclusive of all taxes including GST.
 ■ Price available on request.

DRX MCCB

DRX MCCB Accessories

NEW!



4222 42

Frame	Accessory	CAT No.	MRP* ₹ / Unit	Pack
DRX 630	Shunt - 230V AC	4222 42	2310	1
	Shunt - 415V AC	4222 43	2310	1
	UV Coil - 230V AC	4222 48	2704	1
	UV Coil - 415V AC	4222 49	2704	1
	Auxilliary Contact OR Trip Contact	4210 11	1156	1
	Padlock	0262 40	1892	1
	Phase Barriers	0262 30	186	1
	Direct Handle	6687 80	1568	1
	Extended/ Vary Depth Handle	6687 81	2800	1
	Spreaders - 3P	6250 04	1470	1
	Spreaders - 4P	6250 08	1996	1
	Vary depth handle random keylock-DRX 630	6687 82	1836	1
	Vary depth handle type A keylock-DRX 630	6687 83	1836	1
	Vary depth handle type B keylock-DRX 630	6687 84	1836	1

Bold Cat.Nos are products normally available with Legrand (India) Stockists. Cat.Nos that are not bold - delivery within 4 - 8 weeks from the date of order. Bold packing quantity is our mandatory packing. Orders to be placed by Legrand (India) Stockist in multiples of the same.

CTX³ RTX³ MPX³

UNCOMPROMISING
PERFORMANCE FOR
MOTOR PROTECTION
AND CONTROL



A COMPLETE RANGE OF DEVICES FOR THE PROTECTION AND CONTROL OF MOTORS

CTX³ CONTACTORS AND RTX³ THERMAL RELAYS UP TO 800 A

- Compact size
- High mechanical and electrical endurance for maximum reliability
- Lowest watt loss
- 3-Pole and 4-pole contactors
- Screw terminals
- Complete range of auxiliaries and accessories

MPX³ MOTOR PROTECTION CIRCUIT BREAKERS UP TO 100 A

- High breaking capacity and type 2 coordination for an optimum service level
- Trip class 10
- Sensitive to phase loss
- Compact size
- Can be fixed on 35 mm DIN rail or using screws
- Easy combination with CTX³ 3-pole contactors
- Complete range of control and signalling auxiliaries and accessories

Mini contactors CTX³ 6 to 16 A industrial contactors

Cat.Nos	Max. opt. current AC 3	Max. opt. current AC 1	Control voltage	MRP* ₹ / Unit	Pack
---------	------------------------	------------------------	-----------------	---------------	------

An Ultra Compact Solution Upto 16A (AC3) 3P & 4P

For Switching Motors, Lighting and Heating Circuits
Ultra High Reliability
Ultra High Endurance
Ultra Low Wattloss

Features

Conforms to IEC/EN 60947-4-1
CE & UL Certified
Range From 6A to 16A AC3
Available in 3P & 4P
Click fit accessories
Ultra Compact design
Front and side add on auxiliary contact
Mechanical Interlock unit
mini Thermal Overload Relay

Spare Coils available

RoHS Compliant

3 pole mini contactors

With integrated auxiliary contact
Power terminals: screw terminals

6 A - Integrated auxiliary contact 1 NO

4170 00	6 A	20 A	24 V~	1050	1
4170 01	6 A	20 A	24 V=	1576	1
4170 04	6 A	20 A	110 V~	1050	1
4170 06	6 A	20 A	230 V~	1050	1
4170 09	6 A	20 A	415 V~	1050	1

6 A - Integrated auxiliary contact 1 NC

4170 10	6 A	20 A	24 V~	1050	1
4170 11	6 A	20 A	24 V=	1576	1
4170 14	6 A	20 A	110 V~	1050	1
4170 16	6 A	20 A	230 V~	1050	1
4170 19	6 A	20 A	415 V~	1050	1

9 A - Integrated auxiliary contact 1 NO

4170 20	9 A	20 A	24 V~	1152	1
4170 21	9 A	20 A	24 V=	1674	1
4170 24	9 A	20 A	110 V~	1152	1
4170 26	9 A	20 A	230 V~	1152	1
4170 29	9 A	20 A	415 V~	1152	1

9 A - Integrated auxiliary contact 1 NC

4170 30	9 A	20 A	24 V~	1152	1
4170 31	9 A	20 A	24 V=	1674	1
4170 34	9 A	20 A	110 V~	1152	1
4170 36	9 A	20 A	230 V~	1152	1
4170 39	9 A	20 A	415 V~	1152	1

12 A - Integrated auxiliary contact 1 NO

4170 40	12 A	20 A	24 V~	1248	1
4170 41	12 A	20 A	24 V=	2050	1
4170 44	12 A	20 A	110 V~	1248	1
4170 46	12 A	20 A	230 V~	1248	1
4170 49	12 A	20 A	415 V~	1248	1

12 A - Integrated auxiliary contact 1 NC

4170 50	12 A	20 A	24 V~	1248	1
4170 51	12 A	20 A	24 V=	2050	1
4170 54	12 A	20 A	110 V~	1248	1
4170 56	12 A	20 A	230 V~	1248	1
4170 59	12 A	20 A	415 V~	1248	1

* MRP - Maximum Retail Price Inclusive of all taxes including GST.

Mini contactors CTX³ 6 to 16 A industrial contactors

Cat.Nos	Max. opt. current AC 3	Max. opt. current AC 1	Control voltage	MRP* ₹ / Unit	Pack
---------	------------------------	------------------------	-----------------	---------------	------

16 A - Integrated auxiliary contact 1 NO

4170 60	16 A	20 A	24 V~	1502	1
4170 61	16 A	20 A	24 V=	2376	1
4170 64	16 A	20 A	110 V~	1502	1
4170 66	16 A	20 A	230 V~	1502	1
4170 69	16 A	20 A	415 V~	1502	1

16 A - Integrated auxiliary contact 1 NC

4170 70	16 A	20 A	24 V~	1502	1
4170 71	16 A	20 A	24 V=	2376	1
4170 74	16 A	20 A	110 V~	1502	1
4170 76	16 A	20 A	230 V~	1502	1
4170 79	16 A	20 A	415 V~	1502	1

4-pole mini contactors

Without integrated auxiliary contact
Power terminals: screw terminals

Cat.Nos	Max. opt. current AC 1	Max. opt. current AC 3	Control voltage	MRP* ₹ / Unit	Pack
---------	------------------------	------------------------	-----------------	---------------	------

20 A

4171 40	20 A	16 A	24 V~	1412	1
4171 41	20 A	16 A	24 V=	2218	1
4171 44	20 A	16 A	110 V~	1412	1
4171 46	20 A	16 A	230 V~	1412	1
4171 49	20 A	16 A	415 V~	1412	1

Mini Thermal Overload Relays RTX³ mini

for mini contactors

Cat.Nos	Setting Range	MRP* ₹ / Unit	Pack
---------	---------------	---------------	------

Features

Conforms to IEC/EN 60947-4-1
CE & UL Certified
Thermal protection of circuits against overload, long starting times, and phase failure
Trip Class 10A
Trip Indication
Manual/Automatic Reset
Integrated auxiliary contacts 1 NO & 1 NC

Thermal overload relays for 3 pole mini contactors

Class 10 A - Integrated auxiliary contacts 1 NO + 1 NC

4170 80	0.1~0.16 A	1256	1
4170 81	0.16~0.25 A	1256	1
4170 82	0.25~0.4 A	1256	1
4170 83	0.4~0.63 A	1256	1
4170 84	0.63~1 A	1256	1
4170 85	1~1.6 A	1256	1
4170 86	1.6~2.5 A	1256	1
4170 87	2.5~4 A	1256	1
4170 88	4~6 A	1256	1
4170 89	5~8 A	1256	1
4170 90	6~9 A	1256	1
4170 91	7~10 A	1256	1
4170 92	9~13 A	1256	1
4170 93	12~16 A	1256	1



4170 88

Bold Cat.Nos are products normally available with Legrand (India) Stockists. Cat.Nos that are not bold - delivery within 4 - 8 weeks from the date of order. Bold packing quantity is our mandatory packing. Orders to be placed by Legrand (India) Stockist in multiples of the same.

Mini Thermal Overload Relays

RTX³ mini

Accessories for mini Contactors CTX³

Cat.Nos	Setting Range	MRP* ₹ / Unit	Pack
---------	---------------	------------------	------

Add on auxiliary blocks for mini contactors

High Thermal current - 10 A
lth: 10 A

Front mounting

4171 50	1 NO + 1 NC	372	10
4171 51	2 NO	372	10
4171 52	2 NC	372	10
4171 53	4 NO	568	10
4171 54	3 NO + 1 NC	568	10
4171 55	2 NO + 2 NC	568	10
4171 56	1 NO + 3 NC	568	10
4171 57	4 NC	568	10

Side mounting

4171 58	1 NO	372	10
4171 59	1 NC	372	10

Interlock Unit

4171 60	Mechanical interlock for mini contactors	594	5
---------	------------------------------------------	-----	---

Spare coils

4171 70	24 V~	682	5
4171 71	24 V=	926	5
4171 74	110 V~	682	5
4171 76	230 V~	682	5
4171 79	415 V~	682	5

Power contactors CTX³

Uncompromising Performance for

Motor Protection & Control

Range from 9A to 800A (AC3) Contactors

Features

Conforms to IEC/EN 60947-4-1
CE & UL Certified
Extra Mechanical life upto 15 Million
Extra Electrical life upto 2.5 Million
Extra Low Consumption
Compact size
integrated auxiliary contacts

Front safety Cover to prevent dust entry

Direct Clipping on Din Rail

Both Sides Terminal connection

Click fit accessories

Interlocking kits

Spare Coils

RoHS Compliant

3 pole contactors CTX³

9 A to 100 A industrial contactors

Cat.Nos	Max. opt. current AC 3	Max. opt. current AC 1	Control voltage	MRP* ₹ / Unit	Pack
---------	---------------------------	---------------------------	-----------------	------------------	------

CTX³ 22

With integrated auxiliary contacts

Power terminals: screw terminals

9 A - Integrated auxiliary contacts 1 NO + 1 NC

4160 80	9 A	25 A	24 V~	1164	1
4160 81	9 A	25 A	24 V=	2118	1
4160 82	9 A	25 A	48 V~	1164	1
4160 83	9 A	25 A	48 V=	2118	1
4160 84	9 A	25 A	110 V~	1164	1
4160 86	9 A	25 A	230 V~	1164	1
4160 88	9 A	25 A	380 V~	1164	1
4160 89	9 A	25 A	415 V~	1164	1

* MRP - Maximum Retail Price Inclusive of all taxes including GST.

3 pole contactors CTX³

9 A to 100 A industrial contactors

Cat.Nos	Max. opt. current AC 3	Max. opt. current AC 1	Control voltage	MRP* ₹ / Unit	Pack
---------	---------------------------	---------------------------	-----------------	------------------	------

12 A - Integrated auxiliary contacts 1 NO + 1 NC

4160 90	12 A	25 A	24 V~	1318	1
4160 91	12 A	25 A	24 V=	2290	1
4160 92	12 A	25 A	48 V~	1318	1
4160 93	12 A	25 A	48 V=	2290	1
4160 94	12 A	25 A	110 V~	1318	1
4160 96	12 A	25 A	230 V~	1318	1
4160 98	12 A	25 A	380 V~	1318	1
4160 99	12 A	25 A	415 V~	1318	1

18 A - Integrated auxiliary contacts 1 NO + 1 NC

4161 00	18 A	40 A	24 V~	1532	1
4161 01	18 A	40 A	24 V=	2824	1
4161 02	18 A	40 A	48 V~	1532	1
4161 03	18 A	40 A	48 V=	2824	1
4161 04	18 A	40 A	110 V~	1532	1
4161 06	18 A	40 A	230 V~	1532	1
4161 08	18 A	40 A	380 V~	1532	1
4161 09	18 A	40 A	415 V~	1532	1

22 A - Integrated auxiliary contacts 1 NO + 1 NC

4161 10	22 A	40 A	24 V~	1918	1
4161 11	22 A	40 A	24 V=	3630	1
4161 12	22 A	40 A	48 V~	1918	1
4161 13	22 A	40 A	48 V=	3630	1
4161 14	22 A	40 A	110 V~	1918	1
4161 16	22 A	40 A	230 V~	1918	1
4161 18	22 A	40 A	380 V~	1918	1
4161 19	22 A	40 A	415 V~	1918	1

CTX³ 40

With integrated auxiliary contacts

Power terminals: screw terminals

32 A - Integrated auxiliary contacts 2 NO + 2 NC

4161 20	32 A	50 A	24 V~	3976	1
4161 21	32 A	50 A	24 V=	7840	1
4161 22	32 A	50 A	48 V~	3976	1
4161 23	32 A	50 A	48 V=	7840	1
4161 24	32 A	50 A	110 V~	3976	1
4161 26	32 A	50 A	230 V~	3976	1
4161 28	32 A	50 A	380 V~	3976	1
4161 29	32 A	50 A	415 V~	3976	1

40 A - Integrated auxiliary contacts 2 NO + 2 NC

4161 30	40 A	60 A	24 V~	5900	1
4161 31	40 A	60 A	24 V=	9922	1
4161 32	40 A	60 A	48 V~	5900	1
4161 33	40 A	60 A	48 V=	9922	1
4161 34	40 A	60 A	110 V~	5900	1
4161 36	40 A	60 A	230 V~	5900	1
4161 38	40 A	60 A	380 V~	5900	1
4161 39	40 A	60 A	415 V~	5900	1

CTX³ 65

With integrated auxiliary contacts

50 A - Integrated auxiliary contacts 2 NO + 2 NC

Screw terminals

4161 40	50 A	70 A	24 V~	7224	1
4161 41	50 A	70 A	24 V=	11990	1
4161 42	50 A	70 A	48 V~	7224	1
4161 43	50 A	70 A	48 V=	11990	1
4161 44	50 A	70 A	110 V~	7224	1
4161 46	50 A	70 A	230 V~	7224	1
4161 48	50 A	70 A	380 V~	7224	1
4161 49	50 A	70 A	415 V~	7224	1

Bold Cat.Nos are products normally available with Legrand (India) Stockists. Cat.Nos that are not bold - delivery within 4 - 8 weeks from the date of order. Bold packing quantity is our mandatory packing. Orders to be placed by Legrand (India) Stockist in multiples of the same.



4171 55



4160 96



4161 26



4161 46

3 pole contactors CTX³ 9 A to 100 A industrial contactors

Cat.Nos	Max. opt. current AC 3	Max. opt. current AC 1	Control voltage	MRP* ₹ / Unit	Pack
65 A - Integrated auxiliary contacts 2 NO + 2 NC Screw terminals					
4161 60	65 A	100 A	24 V~	9692	1
4161 61	65 A	100 A	24 V=	13468	1
4161 62	65 A	100 A	48 V~	9692	1
4161 63	65 A	100 A	48 V=	13468	1
4161 64	65 A	100 A	110 V~	9692	1
4161 66	65 A	100 A	230 V~	9692	1
4161 68	65 A	100 A	380 V~	9692	1
4161 69	65 A	100 A	415 V~	9692	1

CTX³ 100

With integrated auxiliary contacts

75 A - Integrated auxiliary contacts 2 NO + 2 NC
Screw terminals

4161 80	75 A	110 A	24 V~	12028	1
4161 81	75 A	110 A	24 V=	15798	1
4161 82	75 A	110 A	48 V~	12028	1
4161 83	75 A	110 A	48 V=	15798	1
4161 84	75 A	110 A	110 V~	12028	1
4161 86	75 A	110 A	230 V~	12028	1
4161 88	75 A	110 A	380 V~	12028	1
4161 89	75 A	110 A	415 V~	12028	1

85 A - Integrated auxiliary contacts 2 NO + 2 NC
Screw terminals

4162 00	85 A	135 A	24 V~	12454	1
4162 01	85 A	135 A	24 V=	16712	1
4162 02	85 A	135 A	48 V~	12454	1
4162 03	85 A	135 A	48 V=	16712	1
4162 04	85 A	135 A	110 V~	12454	1
4162 06	85 A	135 A	230 V~	12454	1
4162 08	85 A	135 A	380 V~	12454	1
4162 09	85 A	135 A	415 V~	12454	1

100 A - Integrated auxiliary contacts 2 NO + 2 NC
Screw terminals

4162 20	100 A	160 A	24 V~	15234	1
4162 21	100 A	160 A	24 V=	20428	1
4162 22	100 A	160 A	48 V~	15234	1
4162 23	100 A	160 A	48 V=	20428	1
4162 24	100 A	160 A	110 V~	15234	1
4162 26	100 A	160 A	230 V~	15234	1
4162 28	100 A	160 A	380 V~	15234	1
4162 29	100 A	160 A	415 V~	15234	1

3 pole contactors CTX³ 130 A to 800 A industrial contactors

CTX 150

With integrated auxiliary contacts

130 A - Integrated auxiliary contacts 2 NO + 2 NC
Screw terminals

4162 40	130 A	160 A	24 V~	23300	1
4162 41	130 A	160 A	24 V=	29676	1
4162 42	130 A	160 A	48 V~	23300	1
4162 43	130 A	160 A	48 V=	29676	1
4162 46	130 A	160 A	100-240 V~/=	23300	1
4162 49	130 A	160 A	400-440 V~	23300	1

150 A - Integrated auxiliary contacts 2 NO + 2 NC
Screw terminals

4162 60	150 A	210 A	24 V~	23392	1
4162 61	150 A	210 A	24 V=	27822	1
4162 62	150 A	210 A	48 V~	23392	1
4162 63	150 A	210 A	48 V=	27822	1

* MRP - Maximum Retail Price Inclusive of all taxes including GST.

3 pole contactors CTX³ 130 A to 800 A industrial contactors

Cat.Nos	Max. opt. current AC 3	Max. opt. current AC 1	Control voltage	MRP* ₹ / Unit	Pack
150 A - Integrated auxiliary contacts 2 NO + 2 NC Screw terminals					
4162 66	150 A	210 A	100-240 V~/=	23392	1
4162 69	150 A	210 A	400-440 V~	23392	1

CTX³ 225

With integrated auxiliary contacts - Screw terminals

185 A - Integrated auxiliary contacts 2 NO + 2 NC

4162 80	185 A	230 A	24 V~/=	34564	1
4162 82	185 A	230 A	48 V~/=	34564	1
4162 86	185 A	230 A	100-240 V~/=	27132	1
4162 89	185 A	230 A	380-450 V~	27132	1

225 A - Integrated auxiliary contacts 2 NO + 2 NC

4162 90	225 A	275 A	24 V~/=	37650	1
4162 92	225 A	275 A	48 V~/=	37650	1
4162 96	225 A	275 A	100-240 V~/=	30708	1
4162 99	225 A	275 A	380-450 V~	30708	1

CTX³ 400

With integrated auxiliary contacts - Screw terminals

265 A - Integrated auxiliary contacts 2 NO + 2 NC

4163 06	265 A	300 A	100-240 V~/=	36718	1
4163 09	265 A	300 A	380-450 V~	36718	1

330 A - Integrated auxiliary contacts 2 NO + 2 NC

4163 16	330 A	350 A	100-240 V~/=	41992	1
4163 19	330 A	350 A	380-450 V~	41992	1

400 A - Integrated auxiliary contacts 2 NO + 2 NC

4163 26	400 A	450 A	100-240 V~/=	50892	1
4163 29	400 A	450 A	380-450 V~	50892	1

CTX³ 800

With integrated auxiliary contacts - Screw terminals

500 A - Integrated auxiliary contacts 2 NO + 2 NC

4163 36	500 A	580 A	200-240 V~/=	75742	1
4163 39	500 A	580 A	380-450 V~	75742	1

630 A - Integrated auxiliary contacts 2 NO + 2 NC

4163 46	630 A	660 A	200-240 V~/=	107856	1
4163 49	630 A	660 A	380-450 V~	107856	1

800 A - Integrated auxiliary contacts 2 NO + 2 NC

4163 56	800A	900 A	200-240 V~/=	163934	1
4163 59	800 A	900 A	380-450 V~	163934	1

Bold Cat.Nos are products normally available with Legrand (India) Stockists. Cat.Nos that are not bold - delivery within 4 - 8 weeks from the date of order. Bold packing quantity is our mandatory packing. Orders to be placed by Legrand (India) Stockist in multiples of the same.



4161 86



4162 96



4162 46



4163 56

Thermal relays RTX³

for CTX³ 3 pole industrial contactors

Cat.Nos	I min. (A)	I max. (A)	MRP* ₹ / Unit	Pack
---------	---------------	---------------	---------------------	------

Features

Conforms to IEC/EN 60947-4-1

CE & UL Certified

Thermal protection of circuits against overload, long starting times, and phase failure

Trip Class 10A

Trip Indication

Manual/Automatic Reset

Integrated auxiliary contacts 1 NO & 1 NC

Standard type:

- Overload detecting bimetal is used all for three phases

Differential type:

- Standard type characteristics + phase failure protection

Thermal overload relays

Class 10A - Integrated auxiliary contacts 1 NO + 1 NC

RTX³ 40 - for CTX³ 22 and 40

Standard type with screw terminals

Cat.Nos	I min. (A)	I max. (A)	MRP* ₹ / Unit	Pack
4166 40	0.1	0.16	1598	1
4166 41	0.16	0.25	1598	1
4166 42	0.25	0.4	1598	1
4166 43	0.4	0.63	1598	1
4166 44	0.63	1	1598	1
4166 45	1	1.6	1598	1
4166 46	1.6	2.5	1598	1
4166 47	2.5	4	1598	1
4166 48	4	6	1598	1
4166 49	5	8	1598	1

RTX³ 40 - for CTX³ 22 and 40

Standard type with screw terminals

Cat.Nos	I min. (A)	I max. (A)	MRP* ₹ / Unit	Pack
4166 50	6	9	1598	1
4166 51	7	10	1598	1
4166 52	9	13	1598	1
4166 53	12	18	1598	1
4166 54	16	22	1674	1
4166 55	18	25	1692	1
4166 56	22	32	1922	1
4166 57	28	40	2068	1



4167 31



4167 65

Thermal relays RTX³

for CTX³ 3 pole industrial contactors

Cat.Nos	I min. (A)	I max. (A)	MRP* ₹ / Unit	Pack
---------	---------------	---------------	---------------------	------

RTX³ 40 - for CTX³ 22 and 40

Differential type with screw terminals

Cat.Nos	I min. (A)	I max. (A)	MRP* ₹ / Unit	Pack
4166 60	0.1	0.16	1914	1
4166 61	0.16	0.25	1914	1
4166 62	0.25	0.4	1914	1
4166 63	0.4	0.63	1930	1
4166 64	0.63	1	1930	1
4166 65	1	1.6	1930	1
4166 66	1.6	2.5	1930	1
4166 67	2.5	4	1930	1
4166 68	4	6	1940	1
4166 69	5	8	1940	1
4166 70	6	9	1940	1
4166 71	7	10	1940	1
4166 72	9	13	1940	1
4166 73	12	18	2030	1
4166 74	16	22	2030	1
4166 75	18	25	2030	1
4166 76	22	32	2348	1
4166 77	28	40	2348	1

RTX³ 65 - for CTX³ 65

Standard type with screw terminals

Cat.Nos	I min. (A)	I max. (A)	MRP* ₹ / Unit	Pack
4166 83	9	13	3150	1
4166 84	12	18	3150	1
4166 85	16	22	3150	1
4166 86	18	25	3150	1
4166 87	24	36	3150	1
4166 88	28	40	3150	1
4166 89	34	50	3150	1
4166 90	45	65	3150	1

RTX³ 100 - for CTX³ 100

Standard type with screw terminals

Cat.Nos	I min. (A)	I max. (A)	MRP* ₹ / Unit	Pack
4167 23	18	25	4918	1
4167 24	24	36	5058	1
4167 25	28	40	5058	1
4167 26	34	50	5058	1
4167 27	45	65	5058	1
4167 28	54	75	5058	1
4167 29	63	85	5058	1
4167 30	70	95	5058	1
4167 31	80	100	5058	1

RTX³ 150 - for CTX³ 150

Standard type with screw terminals

Cat.Nos	I min. (A)	I max. (A)	MRP* ₹ / Unit	Pack
4167 60	45	65	7438	1
4167 61	54	75	7438	1
4167 62	63	85	7438	1
4167 63	80	105	7438	1
4167 64	95	130	7438	1
4167 65	110	150	7438	1

* MRP - Maximum Retail Price Inclusive of all taxes including GST.

Bold Cat.Nos are products normally available with Legrand (India) Stockists. Cat.Nos that are not bold - delivery within 4 - 8 weeks from the date of order. Bold packing quantity is our mandatory packing. Orders to be placed by Legrand (India) Stockist in multiples of the same.

Thermal relays RTX³

for CTX³ 3 pole industrial contactors

Cat.Nos	Description	MRP* ₹ / Unit	Pack
---------	-------------	------------------	------

Separate mounting units

To mount the relays separately from contactors, on DIN rail or panel by fixing screws

4165 91	For RTX ³ 40 up to 32 A	588	1
4165 92	For RTX ³ 40 40 A	588	1
4165 93	For RTX ³ 65 with screw terminals	726	1
4165 94	For RTX ³ 65 with cage terminals	726	1
4165 95	For RTX ³ 100 with screw terminals	922	1
4165 96	For RTX ³ 100 with cage terminals	922	1
4165 97	For RTX ³ 150 with screw terminals	1456	1
4165 98	For RTX ³ 150 with cage terminals	1456	1

Thermal overload relays

Class 10 A - Integrated auxiliary contacts 1 NO + 1 NC

Cat.Nos	I min. (A)	I max. (A)	MRP* ₹ / Unit	Pack
---------	------------	------------	------------------	------

RTX³ 225 - for CTX³ 225

Differential type with screw terminals

4167 80	65	100	11160	1
4167 81	85	125	11160	1
4167 82	100	160	11538	1
4167 83	120	185	11538	1
4167 84	160	240	11538	1



4167 84

RTX³ 400 - for CTX³ 400

Differential type with screw terminals

4167 86	85	125	14186	1
4167 87	100	160	14186	1
4167 88	120	185	14186	1
4167 89	160	240	14186	1
4167 90	200	330	14186	1
4167 91	260	400	14186	1

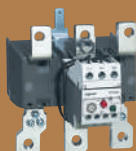

4167 91

RTX³ 800 - for CTX³ 800

Differential type with screw terminals

4167 92	200	300	22062	1
4167 93	260	400	22062	1
4167 94	400	630	22062	1
4167 95	520	800	22062	1



4164 36

4-pole contactors CTX³

40 A to 900 A industrial contactors and spare coils

Cat.Nos	Max. opt. current AC 1	Max. opt. current AC 3	Control voltage	MRP* ₹ / Unit	Pack
---------	------------------------	------------------------	-----------------	------------------	------

Contactors CTX³

Power terminals: screw terminals

Without integrated auxiliary contact

4164 26	40 A	22 A	230 V~	2626	1
4164 36	60 A	40 A	230 V~	6662	1
4164 46	100 A	65 A	230 V~	10798	1
4164 56	135 A	85 A	230 V~	13804	1



4164 56

* MRP - Maximum Retail Price Inclusive of all taxes including GST.

4-pole contactors CTX³

40 A to 900 A industrial contactors and spare coils

Cat.Nos	Max. opt. current AC 1	Max. opt. current AC 3	Control voltage	MRP* ₹ / Unit	Pack
---------	------------------------	------------------------	-----------------	------------------	------

With integrated auxiliary contacts

Auxiliary contacts: 2 NO + 2 NC

4164 66	165 A	130 A	100-240 V~/=	22430	1
4164 76	250 A	150 A	100-240 V~/=	29566	1
4164 86	330 A	225 A	100-240 V~/=	33540	1
4164 96	420 A	330 A	100-240 V~/=	60846	1
4165 06	500 A	400 A	100-240 V~/=	65342	1
4165 16	750 A	630 A	200-240 V~/=	136406	1
4165 26	900 A	800 A	200-240 V~/=	157340	1



4164 86

Spare coils for CTX³ 4P contactors

Cat.Nos	Description	MRP* ₹ / Unit	Pack
---------	-------------	------------------	------

Control voltage 230 V~

4165 46	For CTX ³ 40 A to 60 A (AC-1)	1312	1
4165 56	For CTX ³ 100 A to 135 A (AC-1)	1444	1
4165 66	For CTX ³ 165 A to 330 A (AC-1)	8200	1
4165 76	For CTX ³ 420 A to 500 A (AC-1)	15306	1
4165 86	For CTX ³ 750 A to 900 A (AC-1)	22960	1

CTX³ add-on auxiliary contact blocks

Front mounting

For CTX³ 3P form 9 A to 150 A (AC-3) and CTX³ 4P from 40 A to 135 A (AC-1) - 2 and 4 pole - lth: 16 A

4168 50	1 NO + 1 NC	372	10
4168 51	2 NO	372	10
4168 52	2 NC	372	10
4168 53	4 NO	592	10
4168 54	3 NO + 1 NC	592	10
4168 55	2 NO + 2 NC	592	10
4168 56	1 NO + 3 NC	592	10
4168 57	4 NC	592	10



4168 50



4168 55

Side mounting

2 pole - Mounting on both sides

4168 58	For CTX ³ 3P Form 9 A to 150 A (AC-3) 1 NO + 1 NC - lth: 16 A	656	10
4168 59	For CTX ³ 3P Form 185 A to 800 A (AC-3) and CTX ³ 4P from 165 A to 900 A (AC-1) 1 NO + 1 NC - lth: 16 A	656	10
4168 49	For CTX ³ 4P From 40 A to 135 A (AC-1) 1 NO + 1 NC - lth: 16 A	648	10

Bold Cat.Nos are products normally available with Legrand (India) Stockists. Cat.Nos that are not bold - delivery within 4 - 8 weeks from the date of order. Bold packing quantity is our mandatory packing. Orders to be placed by Legrand (India) Stockist in multiples of the same.

4-pole contactors CTX³

40 A to 900 A industrial contactors and spare coils



Cat.Nos	Description	MRP* ₹ / Unit	Pack
---------	-------------	------------------	------

CTX³ time delay blocks

For CTX³ 3P from 9 A to 150 A (AC-3)

Time delay: 1 to 30 s

Front mounting

On delay

4168 70	24-48 V \sim /=	1804	1
4168 71	110-230 V \sim	1804	1

Off delay

4168 72	24-48 V \sim /=	2478	1
4168 73	110-230 V \sim	2478	1

CTX³

capacitor switching units Cat.Nos 4168 74/75/76/77

Capacitor unit is connected to the terminals of the contactor to reduce the high inrush current.

IEC 60947-4-1 AC 6b

Type	Contactor		Maximum operating power (kVAR)			Max. Peak current (A)
			220 - 240 V	400 - 480 V	500 - 550 V	
4168 74	CTX ³ 22	9 A	5	9.7	14	560
	CTX ³ 22	12 A	6.7	12.5	18	560
	CTX ³ 22	18 A	8.5	16.7	24	850
	CTX ³ 22	22 A	10	18	26	1250
	CTX ³ 40	32 A	15	25	36	1900
	CTX ³ 40	40 A	20	33.3	48	2160
4168 75/76	CTX ³ 65	50 A	20	40	58	2160
	CTX ³ 65	65 A	25	45.7	66	3040
4168 77	CTX ³ 100	75 A	29.7	54	78	3040
	CTX ³ 100	85 A	35	60	92	3040
	CTX ³ 100	100 A	37	62	94	3040
Without Capacitor Switching Unit as per IEC 60947-4-1 AC 6b	CTX ³ 150	150 A		70		3300
	CTX ³ 225	185 A		84	120	3500
	CTX ³ 225	225 A		115	130	4000
	CTX ³ 400	265 A		125	140	5000
	CTX ³ 400	330 A		139	185	6500
	CTX ³ 400	400 A		185	195	8000
	CTX ³ 800	500 A		220	330	10000
	CTX ³ 800	630 A		291	340	12000
	CTX ³ 800	800 A		369	370	14200

Note:

- When the switch is closed capacitor must be discharged before recharged. (Maximum residual voltage at terminals \leq 50 V)
- To prevent short current, gG type fuse must be 1.5 - 2 times than rated current

CTX³ accessories

CTX³ capacitor switching units

AC-6b

Operating power from 9.7 kVAR to 62 kVAR (400/440 V)

4168 74	For contactors CTX ³ 3P from 9 to 40 A, upto 33.3 kVAR at 440 V / 48 kVAR at 525 V	1820	1
---------	-----------------------------------------------------------------------------------------------	------	---

* MRP - Maximum Retail Price Inclusive of all taxes including GST.

CTX³ accessories

Cat.Nos	Description	MRP* ₹ / Unit	Pack
---------	-------------	------------------	------

CTX³ capacitor switching units

4168 75	For contactors CTX ³ 3P 50 and 65 A with screw terminals upto 45.7 kVAR at 440 V / 66 kVAR at 525 V	2478	1
4168 76	For contactors CTX ³ 3P 50 and 65 A with cage terminals upto 45.7 kVAR at 440 V / 66 kVAR at 525 V	2680	1
4168 77	For contactors CTX ³ 3P 75 to 100 A with screw terminals upto 62 kVAR at 440 V / 94 kVAR at 525 V	2680	1

CTX³ interlocking

Component parts for assembling by customer

Horizontal mounting

Interlock units

4168 79	Mechanical interlocks for CTX ³ 4P from 40 to 135 A (AC-1)	994	5
---------	-----------------------------------------------------------------------	-----	---

Interlock units

4168 80	Mechanical interlocks for CTX ³ 3P from 9 to 150 A Provides 2 NC contacts for use in electrical interlocking	2006	1
4168 87	Mechanical interlocks for CTX ³ 3P from 185 to 400 A and CTX ³ 4P from 165 to 500 A	3610	1

Interlock units

4168 88	Mechanical interlocks for CTX ³ 3P from 500 to 800 A	3940	1
4168 89	Mechanical interlocks for CTX ³ 4P from 750 to 900 A	4160	1

Wire kits

Used for making reversing between two 3P contactors

4168 82	For CTX ³ 22	1050	5
4168 83	For CTX ³ 40	1422	5
4168 84	For CTX ³ 65	1752	5
4168 85	For CTX ³ 100	2934	5

Bold Cat.Nos are products normally available with Legrand (India) Stockists. Cat.Nos that are not bold - delivery within 4 - 8 weeks from the date of order. Bold packing quantity is our mandatory packing. Orders to be placed by Legrand (India) Stockist in multiples of the same.

CTX³ accessories



4168 91



4168 97



4168 40

Cat.Nos	Description	MRP* ₹ / Unit	Pack
---------	-------------	---------------------	------

Boxes for motor starter

For CTX³ 22 equipped with RTX³ 40 (0.1 - 22 A)

4168 90	Without pushbuttons	2676	1
4168 91	With pushbuttons	3280	1

CTX³ transient voltage suppressor blocks

Absorbs the surge arisen out of the coil of the contactor

4168 95	24-48 V \sim /=	536	10
4168 96	100-125 V \sim /=	536	10
4168 97	200-240 V \sim /=	536	10
4168 98	380-400 V \sim	536	10

CTX³ terminals covers

4168 42	For CTX ³ 3P from 185 to 225 A (AC-3)	472	5
4168 43	For CTX ³ 3P from 265 to 400 A (AC-3)	704	5
4168 44	For CTX ³ 3P from 500 to 900 A (AC-3)	1058	5
4168 45	For CTX ³ 4P from 165 to 330 A (AC-1)	590	5
4168 46	For CTX ³ 4P from 420 to 500 A (AC-1)	894	5
4168 47	For CTX ³ 4P from 750 to 900 A (AC-1)	1506	5

CTX³ safety front cover

4168 40	For CTX ³ 3P from 9 to 150 A (AC-3) and CTX ³ 4P from 40 to 135 A (AC-1)	30	50
4168 41	For CTX ³ 3P from 85 to 800 A (AC-3) and CTX 4P from 165 to 900 A (AC-1)	118	50

Distant reset flexible cables for thermal relays

4168 92	400 mm	836	1
4168 93	500 mm	908	1
4168 94	600 mm	922	1

CTX³ spare coils

Spare coils for CTX³ 3P contactors

For CTX³ 22

4169 00	24 V \sim	704	5
4169 02	48 V \sim	704	5
4169 04	110 V \sim	704	5
4169 06	230 V \sim	704	5
4169 08	380 V \sim	704	5
4169 09	415 V \sim	704	5

CTX³ accessories

Cat.Nos	Description	MRP* ₹ / Unit	Pack
---------	-------------	---------------------	------

For CTX³ 40

4169 20	24 V \sim	704	5
4169 21	24 V =	704	5
4169 22	48 V \sim	704	5
4169 23	48 V =	704	5
4169 24	110 V \sim	704	5
4169 26	230 V \sim	704	5
4169 28	380 V \sim	704	5
4169 29	415 V \sim	704	5

For CTX³ 65

4169 30	24 V \sim	904	5
4169 31	24 V =	904	5
4169 32	48 V \sim	904	5
4169 33	48 V =	904	5
4169 34	110 V \sim	904	5
4169 36	230 V \sim	904	5
4169 38	380 V \sim	904	5
4169 39	415 V \sim	904	5

For CTX³ 100

4169 40	24 V \sim	1104	3
4169 41	24 V =	1104	3
4169 42	48 V \sim	1104	3
4169 43	48 V =	1104	3
4169 44	110 V \sim	1104	3
4169 46	230 V \sim	1104	3
4169 48	380 V \sim	1104	3
4169 49	415 V \sim	1104	3

For CTX³ 150

4169 50	24 V \sim	5008	1
4169 51	24 V =	5008	1
4169 52	48 V \sim	5008	1
4169 53	48 V =	5008	1
4169 56	100-240 V \sim /=	5008	1
4169 59	400-440 V \sim	5008	1

For CTX³ 225

4169 60	24 V \sim /=	6464	1
4169 62	48 V \sim /=	6464	1
4169 66	100-240 V \sim /=	6464	1
4169 69	400-440 V \sim	6464	1

For CTX³ 400

4169 76	100-240 V \sim /=	10886	1
4169 79	380-450 V \sim	10886	1

For CTX³ 800

4169 86	200-240 V \sim /=	22360	1
4169 89	380-450 V \sim	22360	1

Auxillary Contactor / Control relays CTX³

4 pole



4169 66

* MRP - Maximum Retail Price Inclusive of all taxes including GST.

Bold Cat.Nos are products normally available with Legrand (India) Stockists. Cat.Nos that are not bold - delivery within 4 - 8 weeks from the date of order. Bold packing quantity is our mandatory packing. Orders to be placed by Legrand (India) Stockist in multiples of the same.

Auxillary Contactor / Control relays CTX³

Cat.Nos	Description	MRP* ₹ / Unit	Pack
---------	-------------	------------------	------

Conform to IEC 60 947-1, IEC 60 947-4-1 and IEC 60 947-5-1 for the auxiliary contacts

CE & UL Certified

Ultra High Ith = 10 A

Ultra Low consumption coil

Click fit accessories

Spare Coils available

RoHS Compliant

CTX³ control relays

4 NO

4168 00	24 V~	1314	1
4168 01	24 V=	2050	1
4168 02	48 V~	1314	1
4168 03	48 V=	2050	1
4168 04	110 V~	1314	1
4168 06	230 V~	1314	1
4168 09	415 V~	1314	1

3 NO + 1 NC

4168 10	24 V~	1314	1
4168 11	24 V=	2050	1
4168 12	48 V~	1314	1
4168 13	48 V=	2050	1
4168 14	110 V~	1314	1
4168 16	230 V~	1314	1
4168 19	415 V~	1314	1

2 NO + 2 NC

4168 20	24 V~	1314	1
4168 21	24 V=	2050	1
4168 22	48 V~	1314	1
4168 23	48 V=	2050	1
4168 24	110 V~	1314	1
4168 26	230 V~	1314	1
4168 29	415 V~	1314	1

Accessories for Auxiliary Contactor / Control Relays

Cat.Nos	Description	MRP* ₹ / Unit	Pack
---------	-------------	------------------	------

High Thermal current - 10 A

Ith : 10 A

Front mounting

4171 50	1 NO + 1 NC	372	10
4171 51	2 NO	372	10
4171 52	2 NC	372	10
4171 53	4 NO	568	10
4171 54	3 NO + 1 NC	568	10
4171 55	2 NO + 2 NC	568	10
4171 56	1 NO + 3 NC	568	10
4171 57	4 NC	568	10

Side mounting

4171 58	1 NO	372	10
4171 59	1 NC	372	10

Interlock Unit

4171 60	Mechanical interlock	594	5
---------	----------------------	-----	---

* MRP - Maximum Retail Price Inclusive of all taxes including GST.

Auxillary Contactor / Control relays CTX³

Cat.Nos	Description	MRP* ₹ / Unit	Pack
---------	-------------	------------------	------

Spare coils

4171 70	24 V~	682	5
4171 71	24 V=	926	5
4171 74	110 V~	682	5
4171 76	230 V~	682	5
4171 79	415 V~	682	5

MPCBs MPX³

motor protection circuit breakers from 0.16 A to 100 A upto 45 KW

Maximum efficiency in a compact unit

Conform to IEC 60947-1, IEC 60947-2, IEC 60947-4

Adjustable thermal release

Magnetic release 13 le max

High breaking capacity

toggle handle

Fixing on rail or by screw

Wide range of accessories

Undervoltage Release

Shunt Release

Auxillary Contacts

IP 65 Enclosure

Thermal magnetic MPCBs

Adjustable thermal release Magnetic release 13 le max.

MPX³ 32S - 3P

Standard breaking capacity with toggle handle

Fixing on rail

415 V breaking capacity Icu (kA) - 100

Cat.Nos	Rated 3Ph Motor (KW)	Thermal release adj. range (A)	Magnetic release operating current (A)	MRP* ₹ / Unit	Pack
---------	----------------------	--------------------------------	----------------------------------------	------------------	------

4173 00	0.02	0.1 to 0.16	2.1	3152	1
4173 01	0.06	0.16 to 0.25	3.3	3152	1
4173 02	0.09	0.25 to 0.4	5.2	3152	1
4173 03	0.12	0.4 to 0.63	8.2	3664	1
4173 04	0.18 / 0.25	0.63 to 1	13	3664	1
4173 05	0.37 / 0.55	1 to 1.6	20.8	3688	1
4173 06	0.75	1.6 to 2.5	32.5	3758	1
4173 07	1.5	2.5 to 4	52	3888	1
4173 08	2.2	4 to 6	78	3798	1
4173 09	3	5 to 8	104	3798	1

415 V breaking capacity Icu (kA) - 50

4173 10	4	6 to 10	130	3798	1
4173 11	5.5	9 to 13	169	3682	1

415 V breaking capacity Icu (kA) - 20

4173 12	7.5	11 to 17	221	4642	1
---------	-----	----------	-----	------	---

415 V breaking capacity Icu (kA) - 15

4173 13	7.5	14 to 22	286	4926	1
4173 14	11	18 to 26	338	5302	1
4173 15	15	22 to 32	416	8728	1

Bold Cat.Nos are products normally available with Legrand (India) Stockists. Cat.Nos that are not bold - delivery within 4 - 8 weeks from the date of order. Bold packing quantity is our mandatory packing. Orders to be placed by Legrand (India) Stockist in multiples of the same.



4168 10



4173 08

MPCBs MPX³ motor protection circuit breakers from 0.16 A to 100 A upto 45 KW

Cat.Nos	Rated 3Ph Motor (KW)	Thermal release adj. range (A)	Magnetic release operating current (A)	MRP* ₹ / Unit	Pack
---------	----------------------------	--------------------------------------	-------------------------------------------------	---------------------	------

MPX³ 32H - 3P

High breaking capacity with rotary handle
415 V breaking capacity Icu (kA) - 100

4173 20	0.02	0.1 to 0.16	2.1	3930	1
4173 21	0.06	0.16 to 0.25	3.3	3930	1
4173 22	0.09	0.25 to 0.4	5.2	3930	1
4173 23	0.12	0.4 to 0.63	8.2	4308	1
4173 24	0.18 / 0.25	0.63 to 1	13	4308	1
4173 25	0.37/ 0.55	1 to 1.6	20.8	4308	1
4173 26	0.75	1.6 to 2.5	32.5	4308	1
4173 27	1.5	2.5 to 4	52	4442	1
4173 28	2.2	4 to 6	78	4418	1
4173 29	3	5 to 8	104	4820	1
4173 30	4	6 to 10	130	4730	1
4173 31	5.5	9 to 13	169	5346	1

415 V breaking capacity Icu (kA) - 50

4173 32	7.5	11 to 17	221	5667	1
4173 33	7.5	14 to 22	286	6630	1
4173 34	11	18 to 26	338	6630	1
4173 35	15	22 to 32	416	10386	1

MPX³ 63H - 3P

High breaking capacity with rotary handle
Fixing on rail or by screw
415 V breaking capacity Icu (kA) - 100

4173 60	4	6 to 10	130	10084	1
4173 61	5.5	9 to 13	169	10084	1

415 V breaking capacity Icu (kA) - 50

4173 62	7.5	11 to 17	221	10084	1
4173 63	7.5	14 to 22	286	11430	1
4173 64	11	18 to 26	338	11430	1
4173 65	15	22 to 32	416	11430	1
4173 66	18.5	28 to 40	520	12774	1
4173 67	22	34 to 50	650	15690	1
4173 68	30	45 to 63	819	16584	1

MPX³ 100H - 3P

High breaking capacity with rotary handle
Fixing on rail or by screw
415 V breaking capacity Icu (kA) - 100

4173 70	7.5	11 to 17	221	13940	1
4173 71	7.5	14 to 22	286	13940	1
4173 72	11	18 to 26	338	13940	1
4173 73	15	22 to 32	416	13940	1
4173 74	18.5	28 to 40	520	13940	1
4173 75	22	34 to 50	650	16566	1
4173 76	30	45 to 63	819	17368	1

415 V breaking capacity Icu (kA) - 75

4173 77	37	55 to 75	975	18674	1
4173 78	45	70 to 90	1170	18674	1
4173 79	45	80 to 100	1300	18674	1

* MRP - Maximum Retail Price Inclusive of all taxes including GST.



4173 68



4173 79



4173 48



4174 00



4174 03

MPCBs MPX³ motor protection circuit breakers from 0.16 A to 100 A upto 45 KW

Cat.Nos	Rated 3Ph Motor	Magnetic release operating current (A)	MRP* ₹ / Unit	Pack
---------	-----------------------	-------------------------------------------------	---------------------	------

Magnetic only MPCBs

Without thermal release
Magnetic release 13 x le max.

MPX³ 32MA - 3P

High breaking capacity with rotary handle
Fixing on rail
415 V breaking capacity Icu (kA) - 100

4173 40	0.02	2.1	3566	1
4173 41	0.06	3.3	3566	1
4173 42	0.09	5.2	3566	1
4173 43	0.12	8.2	3972	1
4173 44	0.18 / 0.25	13	3972	1
4173 45	0.37 / 0.55	20.8	3972	1
4173 46	0.75	32.5	3972	1
4173 47	1.5	52	4018	1
4173 48	2.2	78	4018	1
4173 49	3	104	4018	1
4173 50	4	130	4240	1
4173 51	5.5	169	4504	1

415 V breaking capacity Icu (kA) - 50

4173 52	7.5	221	5798	1
4173 53	7.5	286	5798	1
4173 54	11	338	5798	1
4173 55	15	416	9590	1

MPCBs MPX³ accessories

Cat.Nos	Description	MRP* ₹ / Unit	Pack
---------	-------------	---------------------	------

Auxiliary contacts

2 pole

Side mounting

Mounting on the left side of MPCBs
Two auxiliary contacts per MPCB

4174 00	1 NO + 1 NC	762	5
4174 01	2 NO	762	5
4174 02	2 NC	762	5

Front mounting

One auxiliary contact per MPCB

4174 03	1 NO + 1 NC	786	5
4174 04	2 NO	786	5
4174 05	2 NC	786	5

Alarm contacts

1 NO + 1 NC

Any trip alarm contact

Operates in case of trip

Mounting on the left side of MPCBs

Set alarm contact first in case of using auxiliary contact together (MPX³ 63H can not accept auxiliary contact and alarm contact together)

4174 06	For MPX ³ 32	1230	1
4174 08	For MPX ³ 63 and 100	1230	1

Magnetic trip alarm contact

Operates in case of instantaneous trip

Mounting on the left side of MPCBs

Set alarm contact first in case of using auxiliary contact together

4174 07	1 NO + 1 NC	1230	1
---------	-------------	------	---

Bold Cat.Nos are products normally available with Legrand (India) Stockists. Cat.Nos that are not bold - delivery within 4 - 8 weeks from the date of order. Bold packing quantity is our mandatory packing. Orders to be placed by Legrand (India) Stockist in multiples of the same.

MPCBs MPX³ accessories



4174 12



4174 22

Cat.Nos	Description	MRP* ₹ / Unit	Pack
---------	-------------	------------------	------

Shunt release

Mounting on the right side of MPCBs
One release per MPCB

4174 10	24 V - 50 Hz / 28 V - 60 Hz	1958	1
4174 11	110 V - 50 Hz / 120 V - 60 Hz	1958	1
4174 12	220-230 V - 50 Hz / 240-260 V - 60 Hz	1958	1
4174 13	380-400 V - 50 Hz / 440-460 V - 60 Hz	1958	1

Undervoltage release

Mounting on the right side of MPCBs
One release per MPCB

Without auxiliary contact

4174 20	24 V - 50 Hz / 28 V - 60 Hz	1958	1
4174 21	110 V - 50 Hz / 120 V - 60 Hz	1958	1
4174 22	220-230 V - 50 Hz / 240-260 V - 60 Hz	1958	1
4174 23	380-400 V - 50 Hz / 440-460 V - 60 Hz	1958	1

With 2 NO auxiliary contacts

Can not attach to MPX³ 32S

4174 30	24 V - 50 Hz / 28 V - 60 Hz	2610	1
4174 31	110 V - 50 Hz / 120 V - 60 Hz	2610	1
4174 32	220-230 V - 50 Hz / 240-260 V - 60 Hz	2610	1
4174 33	380-400 V - 50 Hz / 440-460 V - 60 Hz	2610	1

Dial Cover

Sealable cover to protect the set value from the operation that is not intended

Without auxiliary contact

4174 79	For all types of MPX ³	92	50
---------	-----------------------------------	----	----

Direct adaptor and mounting unit

For mounting CTX³ contactors under MPX³ MPCBs

Direct adaptators

Used to connect MPX³ directly with the contactor

4174 40	For MPX ³ 32S with CTX ³ mini AC	456	2
4174 41	For MPX ³ 32S with CTX ³ mini DC	456	2
4174 42	For MPX ³ 32H/32MA with CTX ³ mini AC	456	2
4174 43	For MPX ³ 32H/32MA with CTX ³ mini DC	456	2
4174 48	For MPX ³ 32S with CTX ³ 22 AC	548	2
4174 49	For MPX ³ 32S with CTX ³ 22 DC	548	2
4174 50	For MPX ³ 32H/32MA with CTX ³ 22 AC	548	2

4174 50

Direct adaptators

Used to connect MPX³ directly with the contactor

4174 51	For MPX ³ 32H/32MA with CTX ³ 22 DC	548	2
---------	--------------------------------------------------------------	-----	---



4174 56



4174 61



4174 63



4174 73



4174 81

MPCBs MPX³ accessories

Cat.Nos	Description	MRP* ₹ / Unit	Pack
---------	-------------	------------------	------

Used to connect MPX³ directly with the contactor

4174 52	For MPX ³ 32S with CTX ³ 40 AC	664	2
4174 53	For MPX ³ 32S with CTX ³ 40 DC	664	2
4174 54	For MPX ³ 32H/32MA with CTX ³ 40 AC	664	2
4174 55	For MPX ³ 32H/32MA with CTX ³ 40 DC	664	2
4174 56	For MPX ³ 63H with CTX ³ 65 AC with cage type terminals	800	2
4174 57	For MPX ³ 63H with CTX ³ 65 DC with cage type terminals	800	2
4174 58	For MPX ³ 100H with CTX ³ 100 AC with cage type terminals	800	1
4174 59	For MPX ³ 100H with CTX ³ 100 DC with cage type terminals	800	1

Mounting unit

This device is used for joining together MPX³ MCPBs and CTX³ contactors

4174 60	For MPX ³ 32S/32H/32MA	618	2
4174 61	For MPX ³ 63H	1140	1
4174 62	For MPX ³ 100H	1374	1

Rotary handle

Mounting on panel's door to control the MPX³

4174 63	For MPX ³ 32H and 32 MA	1805	1
4174 64	For MPX ³ 63H	1805	1
4174 65	For MPX ³ 100H	2286	1

Phase busbar

For parallel connection of MPX³

For MPX³ 32S, 32H and 32MA

Rated current 63 A

4174 71	2 devices	640	5
4174 73	3 devices	1602	5
4174 75	4 devices	1602	5
4174 76	5 devices	1602	5
4174 77	Feeder for phase busbar 32 A	448	5

For MPX³ 63H

Rated current 108 A

4174 72	2 devices	1140	5
4174 74	3 devices	1716	5

Enclosures for MPX³ 32H and 32MA

IP 65 enclosure to use in dusty areas as well as in presence of corrosive gas or liquid

4174 80	Yellow/red with rotary handle	1318	5
4174 81	With black rotary handle	1716	5

* MRP - Maximum Retail Price Inclusive of all taxes including GST.

Bold Cat.Nos are products normally available with Legrand (India) Stockists. Cat.Nos that are not bold - delivery within 4 - 8 weeks from the date of order. Bold packing quantity is our mandatory packing. Orders to be placed by Legrand (India) Stockist in multiples of the same.

DX³

THE NEXT STEP

Presenting, DX³, an international range of protection devices. Its revolutionary design supports all kind of installations thus giving a never before experience. With 10 patents and 13 new features, it defines the next step in the protection category.



COPYTRACER

Anti-counterfeit registration number



Bottom clamp



Improved air channels



Environment friendly



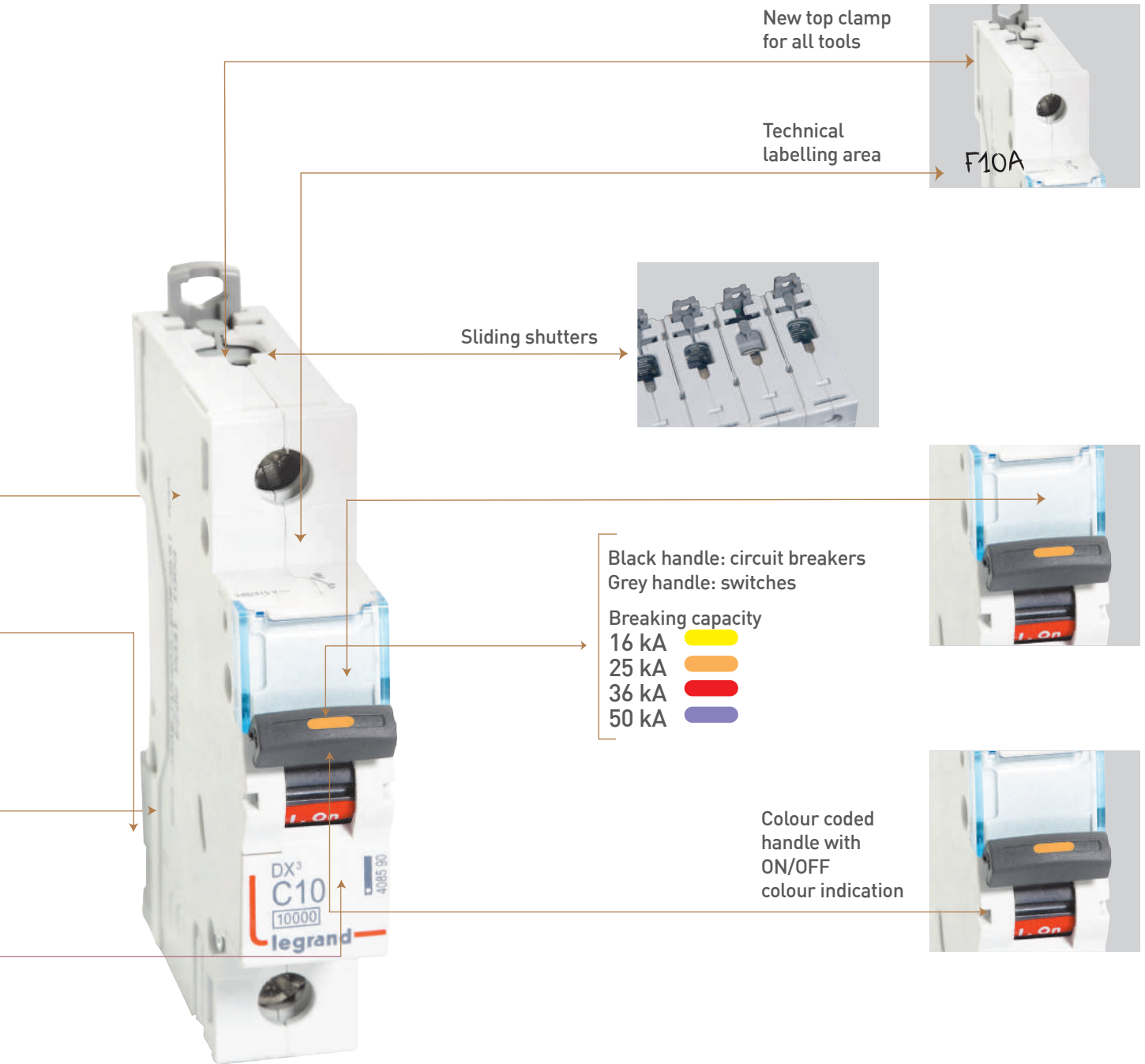

DX³ MCBs

Cat.Nos	Nominal Rating	Number of 17.5 mm modules	MRP* ₹ / Unit	Pack
---------	----------------	---------------------------	---------------	------

MCBs for AC applications till 63 A

10 kA ISI marked as per IS/IEC 60898-1 2002
 Integrated label holder
 Sliding bottom clamp
 Efficient air channels
 Color coded On/Off indication on dolly
 Biconnect lower terminals
 IP 20 protected terminals
 Sliding shutters
 Compatible with signal and control Auxiliaries
 DC-80 V per pole - 1 kA

C Curve

Single pole 240/410 V

4085 80	0.5	1	472	1/10/120
4085 81	1	1	472	1/10/120
4085 83	2	1	472	1/10/120
4085 84	3	1	472	1/10/120
4085 85	4	1	472	1/10/120
4085 87	6	1	306	1/10/120
4085 90	10	1	306	1/10/120
4085 92	16	1	306	1/10/120
4085 93	20	1	306	1/10/120
4085 94	25	1	306	1/10/120
4085 95	32	1	306	1/10/120
4085 96	40	1	678	1/10/120
4085 97	50	1	678	1/10/120
4085 98	63	1	678	1/10/120

Single pole + Neutral 240 V

4086 02	0.5	2	1228	1/5/60
4086 03	1	2	1228	1/5/60
4086 05	2	2	1228	1/5/60
4086 06	3	2	1228	1/5/60
4086 07	4	2	1228	1/5/60
4086 09	6	2	876	1/5/60
4086 12	10	2	876	1/5/60
4086 14	16	2	876	1/5/60
4086 15	20	2	876	1/5/60
4086 16	25	2	876	1/5/60
4086 17	32	2	876	1/5/60
4086 18	40	2	1426	1/5/60
4086 19	50	2	1426	1/5/60
4086 20	63	2	1426	1/5/60

Double pole 415 V

4086 21	0.5	2	1278	1/40
4086 22	1	2	1278	1/40
4086 24	2	2	1278	1/40
4086 25	3	2	1278	1/40
4086 26	4	2	1278	1/40
4086 28	6	2	934	1/40
4086 31	10	2	934	1/40
4086 33	16	2	934	1/40
4086 34	20	2	934	1/40
4086 35	25	2	934	1/40
4086 36	32	2	934	1/40
4086 37	40	2	1502	1/40
4086 38	50	2	1502	1/40
4086 39	63	2	1502	1/40

Triple pole 415 V

4086 43	0.5	3	1882	1/32
4086 44	1	3	1882	1/32
4086 46	2	3	1882	1/32
4086 47	3	3	1882	1/32
4086 48	4	3	1882	1/32
4086 50	6	3	1522	1/32
4086 53	10	3	1522	1/32
4086 55	16	3	1522	1/32
4086 56	20	3	1522	1/32
4086 57	25	3	1522	1/32
4086 58	32	3	1522	1/32
4086 59	40	3	2324	1/32
4086 60	50	3	2324	1/32
4086 61	63	3	2324	1/32

* MRP - Maximum Retail Price Inclusive of all taxes including GST.
 ♦ For further details on product contact nearest Legrand Sales Office.

DX³ MCBs

Cat.Nos	Nominal Rating	Number of 17.5 mm modules	MRP* ₹ / Unit	Pack
---------	----------------	---------------------------	---------------	------

Triple pole + Neutral 415 V

4086 65	0.5	4	2358	1/32
4086 66	1	4	2358	1/32
4086 68	2	4	2358	1/32
4086 69	3	4	2358	1/32
4086 70	4	4	2358	1/32
4086 72	6	4	1962	1/32
4086 75	10	4	1962	1/32
4086 77	16	4	1962	1/32
4086 78	20	4	1962	1/32
4086 79	25	4	1962	1/32
4086 80	32	4	1962	1/32
4086 81	40	4	2828	1/32
4086 82	50	4	2828	1/32
4086 83	63	4	2828	1/32

Four pole 415 V

4086 84	0.5	4	2358	1/32
4086 85	1	4	2358	1/32
4086 87	2	4	2358	1/32
4086 88	3	4	2358	1/32
4086 89	4	4	2358	1/32
4086 91	6	4	2056	1/32
4086 94	10	4	2056	1/32
4086 96	16	4	2056	1/32
4086 97	20	4	2056	1/32
4086 98	25	4	2056	1/32
4086 99	32	4	2056	1/32
4087 00	40	4	2966	1/32
4087 01	50	4	2966	1/32
4087 02	63	4	2966	1/32

D Curve

Single pole 240/415 V

4087 06	0.5	1	472	1/10/120
4087 07	1	1	472	1/10/120
4087 09	2	1	472	1/10/120
4087 10	3	1	472	1/10/120
4087 11	4	1	472	1/10/120
4087 12	6	1	400	1/10/120
4087 14	10	1	400	1/10/120
4087 16	16	1	400	1/10/120
4087 17	20	1	400	1/10/120
4087 18	25	1	400	1/10/120
4087 19	32	1	400	1/10/120
4087 20*	40	1	720	1/10/120
4087 21*	50	1	720	1/10/120
4087 22*	63	1	720	1/10/120

Single pole + Neutral 240 V

4087 26	0.5	2	1240	1/5/60
4087 27	1	2	1240	1/5/60
4087 29	2	2	1240	1/5/60
4087 30	3	2	1240	1/5/60
4087 31	4	2	1240	1/5/60

Double pole 415 V

4087 32	0.5	2	1288	1/40
4087 33	1	2	1288	1/40
4087 35	2	2	1288	1/40
4087 36	3	2	1288	1/40
4087 37	4	2	1288	1/40
4087 38	6	2	964	1/40
4087 40	10	2	964	1/40
4087 42	16	2	964	1/40
4087 43	20	2	964	1/40
4087 44	25	2	964	1/40
4087 45	32	2	964	1/40
4087 46*	40	2	1572	1/40
4087 47*	50	2	1572	1/40
4087 48*	63	2	1572	1/40

Bold Cat.Nos are products normally available with Legrand (India) Stockists.
 Cat.Nos that are not bold - delivery within 4 - 8 weeks from the date of order.
 Bold packing quantity is our mandatory packing. Orders to be placed by Legrand (India) Stockist in multiples of the same.

DX³ MCBs

Cat.Nos	Nominal Rating	Number of 17.5 mm modules	MRP* ₹ / Unit	Pack
---------	----------------	---------------------------	---------------	------

Triple pole 415 V

4087 52	0.5	3	1938	1/32
4087 53	1	3	1938	1/32
4087 55	2	3	1938	1/32
4087 56	3	3	1938	1/32
4087 57	4	3	1938	1/32
4087 58	6	3	1558	1/32
4087 60	10	3	1558	1/32
4087 62	16	3	1558	1/32
4087 63	20	3	1558	1/32
4087 64	25	3	1558	1/32
4087 65	32	3	1558	1/32
4087 66*	40	3	2404	1/32
4087 67*	50	3	2404	1/32
4087 68*	63	3	2404	1/32

Triple pole + Neutral 415 V

4087 72	0.5	4	2358	1/32
4087 73	1	4	2358	1/32
4087 75	2	4	2358	1/32
4087 76	3	4	2358	1/32
4087 77	4	4	2358	1/32

Four pole 415 V

4087 78	0.5	4	2358	1/32
4087 79	1	4	2358	1/32
4087 81	2	4	2358	1/32
4087 82	3	4	2358	1/32
4087 83	4	4	2358	1/32
4087 84	6	4	2056	1/32
4087 86	10	4	2056	1/32
4087 88	16	4	2056	1/32
4087 89	20	4	2056	1/32
4087 90	25	4	2056	1/32
4087 91	32	4	2056	1/32
4087 92*	40	4	3080	1/32
4087 93*	50	4	3080	1/32
4087 94*	63	4	3080	1/32

Circuit breakers AC applications 80 - 125 A

10 kA as per IEC 60947-2
Integrated label holder
Sliding insulating shield
Color coded contact indication window
IP 20 protected terminals
50 sq mm terminals

Single pole 230 V / 400 V

4085 99	80	1.5	2462	1/5/160
4086 00	100	1.5	2730	1/5/161
4086 01	125	1.5	2920	1/5/162

Double pole 230 V / 400 V

4086 40	80	3	5482	1/5/60
4086 41	100	3	5844	1/5/60
4086 42	125	3	6364	1/5/60

Triple pole 400 V

4086 62	80	4.5	8640	1/9
4086 63	100	4.5	9204	1/9
4086 64	125	4.5	10114	1/9

Four pole 400 V

4087 03	80	6	11260	1/9
4087 04	100	6	11730	1/9
4087 05	125	6	13142	1/9

* MRP - Maximum Retail Price Inclusive of all taxes including GST.
♦ For further details on product contact nearest Legrand Sales Office.

DX³ MCBs

Cat.Nos	Nominal Rating	Number of 17.5 mm modules	MRP* ₹ / Unit	Pack
---------	----------------	---------------------------	---------------	------

Circuit breakers DC applications upto 63 A

6 kA as per IEC 60947-2
Integrated label holder
Sliding bottom clamp
Improved air channels
Color coded On/Off indication on dolly
Biconnect lower terminals
IP 20 protected terminals
Sliding shutters

Single pole 250 V

4087 98*	0.5	1	716	1/10/120
4087 99*	1	1	716	1/10/120
4088 01*	2	1	716	1/10/120
4088 02*	3	1	716	1/10/120
4088 03*	4	1	716	1/10/120
4088 04*	6	1	594	1/10/120
4088 06*	10	1	594	1/10/120
4088 08*	16	1	594	1/10/120
4088 09*	20	1	594	1/10/120
4088 10*	25	1	594	1/10/120
4088 11*	32	1	594	1/10/120
4088 12*	40	1	784	1/10/120
4088 13*	50	1	784	1/10/120
4088 14*	63	1	784	1/10/120

Double pole 250 V

4088 15*	0.5	1	1486	1/5/60
4088 16*	1	1	1486	1/5/60
4088 18*	2	1	1488	1/5/60
4088 19*	3	1	1488	1/5/60
4088 20*	4	1	1488	1/5/60
4088 21*	6	1	1366	1/5/60
4088 23*	10	1	1366	1/5/60
4088 25*	16	1	1366	1/5/60
4088 26*	20	1	1366	1/5/60
4088 27*	25	1	1366	1/5/60
4088 28*	32	1	1366	1/5/60
4088 29*	40	1	1610	1/5/60
4088 30*	50	1	1610	1/5/60
4088 31*	63	1	1610	1/5/60

RDSO DC MCB

Single pole

4088 32	0.5	1	754	1/10/120
4088 33	1	1	754	1/10/120
4088 34	1.5	1	754	1/10/120
4088 35	1.6	1	754	1/10/120
4088 36	2.5	1	754	1/10/120
4088 37	3	1	548	1/10/120
4088 38	4	1	548	1/10/120
4088 39	5	1	664	1/10/120
4088 40	10	1	664	1/10/120
4088 41	15	1	664	1/10/120
4088 42	20	1	664	1/10/120
4088 43	25	1	664	1/10/120
4088 44	30	1	758	1/10/120
4088 45	35	1	758	1/10/120
4088 46	40	1	832	1/10/120
4088 47	50	1	832	1/10/120
4088 48	60	1	832	1/10/120

Bold Cat.Nos are products normally available with Legrand (India) Stockists.
Cat.Nos that are not bold - delivery within 4 - 8 weeks from the date of order.
Bold packing quantity is our mandatory packing. Orders to be placed by Legrand (India) Stockist in multiples of the same.



4087 52



4087 90



4086 00



4086 40



4086 62



4087 05



4088 12

DX³ isolators

Cat.Nos	Nominal Rating	Number of 17.5 mm modules	MRP* ₹ / Unit	Pack
---------	----------------	---------------------------	---------------	------

Isolators for AC applications upto 125 A

ISI marked as per IEC 60947-3
 Integrated label holder
 Ergonomic red color dolly
 Sliding bottom clamp
 Double break mechanism
 Improved air channels
 Color coded On/Off indication on dolly
 Biconnect lower terminals
 IP 20 protected terminals
 Compatible with signal and control Auxiliaries
 Sliding shutters

Double pole 240 V

4065 00	32	2	514	1/5/60
4065 01	40	2	566	1/5/60
4065 02	63	2	748	1/5/60
4065 04	100	2	1028	1/5/60
4065 05	125	2	1168	1/5/60

4065 00



4065 10



4065 20

Triple pole 415 V

4065 09	32	3	920	1/40
4065 10	40	3	984	1/40
4065 11	63	3	1166	1/40
4065 13	100	3	1314	1/40
4065 14	125	3	1516	1/40

Four pole 415 V

4065 18	32	4	1010	1/32
4065 19	40	4	1254	1/32
4065 20	63	4	1374	1/32
4065 22	100	4	1708	1/32
4065 23	125	4	1884	1/32

DX³ RCCBs

RCCBs for AC applications upto 63 A

ISI marked as per IS 12640-1
 Integrated label holder
 Ergonomic Grey color dolly
 Sliding bottom clamp
 Compatible with signal and control Auxiliaries
 Color coded On/Off indication on dolly
 Biconnect lower terminals
 IP 20 protected terminals
 35 sq mm terminals
 Sliding shutters

Double pole 240 V

30 mA

4118 51	25	2	3340	1/5/60
4118 52	40	2	3910	1/5/60
4118 53	63	2	4674	1/5/60

4118 51



4118 57

100 mA

4118 56	25	2	3600	1/5/60
4118 57	40	2	4178	1/5/60
4118 58	63	2	4962	1/5/60

300 mA

4118 61	25	2	3666	1/5/60
4118 62	40	2	4268	1/5/60
4118 63	63	2	4994	1/5/60

Four pole 415 V

30 mA

4118 76	25	4	4600	1/32
4118 77	40	4	4544	1/32
4118 78	63	4	5272	1/32

4118 77

DX³ RCCBs

Cat.Nos	Nominal Rating	Number of 17.5 mm modules	MRP* ₹ / Unit	Pack
---------	----------------	---------------------------	---------------	------

100 mA

4118 81	25	4	4774	1/32
4118 82	40	4	4804	1/32
4118 83	63	4	5668	1/32

300 mA

4118 86	25	4	4888	1/32
4118 87	40	4	4962	1/32
4118 88	63	4	5668	1/32

Four pole 415 V, A-S

300 mA

4118 91	25	2	7084	1/5/60
4118 92	40	2	7176	1/5/60
4118 93	63	2	7496	1/5/60
4118 94	80	2	8118	1/5/60

Double pole 240 V, HPI

30 mA

4118 71	25	2	6988	1/5/60
4118 72	40	2	7338	1/5/60
4118 73	63	2	7550	1/5/60
4118 74	80	2	8388	1/5/60

Four pole 415 V, HPI

30 mA

4118 96	25	4	7872	1/32
4118 97	40	4	8120	1/32
4118 98	63	4	8332	1/32
4118 99	80	4	8712	1/32

DX³ circuit breakers

AC applications upto 100 A

Integrated label holder
 Ergonomic Grey color dolly
 Color coded On/Off indication on dolly
 Biconnect lower terminals
 IP 20 protected terminals
 35 sq mm terminals
 Sliding shutters

Double pole 240 V

30 mA

4115 07	80	2	7808	1/5/60
4115 08	100	2	8488	1/5/60

100 mA

4115 17	80	2	7808	1/5/60
4115 18	100	2	8488	1/5/60

300 mA

4115 27	80	2	7808	1/5/60
4115 28	100	2	8488	1/5/60

Four pole 415 V

30 mA

4117 05	80	4	8744	1/32
4117 63	100	4	8844	1/32

100 mA

4117 15	80	4	8744	1/32
4117 73	100	4	8844	1/32

300 mA

4117 25	80	4	8744	1/32
4117 83	100	4	8844	1/32

Bold Cat.Nos are products normally available with Legrand (India) Stockists.
 Cat.Nos that are not bold - delivery within 4 - 8 weeks from the date of order.
 Bold packing quantity is our mandatory packing. Orders to be placed by Legrand (India) Stockist in multiples of the same.

DX³ RCBOs

Cat.Nos	Nominal Rating	Number of 17.5 mm modules	MRP* ₹ / Unit	Pack
---------	----------------	---------------------------	---------------	------

RCBOs assembled for AC applications upto 63 A

ISI marked as per IS 12640-2
Integrated label holder
Ergonomic design
Color coded On/Off indication on dolly
Compatible with signal and control Auxiliaries
Front face indication for earth leakage fault
IP 20 protected terminals
35 sq mm terminals
Sliding shutters

Double pole 240 V, AC Type

30 mA

4113 22	6	4	4092	1/32
4113 23	10	4	4052	1/32
4113 24	16	4	3920	1/32
4113 25	25	4	3920	1/32
4113 26	32	4	4292	1/32
4113 27	40	4	5104	1/32
4113 28	63	4	6106	1/32

100 mA

4113 29	6	4	5096	1/32
4113 30	10	4	5096	1/32
4113 31	16	4	4904	1/32
4113 32	25	4	4814	1/32
4113 33	32	4	4904	1/32
4113 34	40	4	5640	1/32
4113 35	63	4	6530	1/32

300 mA

4113 36	16	4	5068	1/32
4113 37	25	4	5068	1/32
4113 38	32	4	5068	1/32
4113 39	40	4	5806	1/32
4113 40	63	4	6650	1/32

Four pole 415 V, AC Type

30 mA

4113 88	6	7	5608	1/16
4113 89	10	7	5608	1/16
4113 65	16	7	5526	1/16
4113 66	25	7	5526	1/16
4113 67	32	7	5700	1/16
4113 68	40	7	5786	1/16
4113 69	63	7	6852	1/16

Four pole 415 V, AC Type

100 mA

4113 70	16	7	6232	1/16
4113 71	25	7	5964	1/16
4113 72	32	7	6028	1/16
4113 73	40	7	6206	1/16
4113 74	63	7	7050	1/16

Four pole 415 V, AC Type

300 mA

4113 75	16	7	6422	1/16
4113 76	25	7	6200	1/16
4113 77	32	7	6200	1/16
4113 78	40	7	6324	1/16
4113 79	63	7	7172	1/16

RCBOs compact for AC applications upto 32 A, 6 kA

Conforms to IEC 60947
Integrated label holder
Ergonomic design
Color coded On/Off indication on dolly
Front face indication for earth leakage fault
IP 20 protected terminals
35 sq mm terminals
Sliding shutters

Double pole 240 V, AC Type

30 mA

4113 90	6	2	4760	1/32
----------------	---	---	------	------

* MRP - Maximum Retail Price Inclusive of all taxes including GST.

DX³ RCBOs

Cat.Nos	Nominal Rating	Number of 17.5 mm modules	MRP* ₹ / Unit	Pack
---------	----------------	---------------------------	---------------	------

Double pole 240 V, AC Type

30 mA

4113 91	10	2	4760	1/32
4113 92	16	2	4760	1/32
4113 93	20	2	4760	1/32
4113 94	25	2	4760	1/32
4113 95	32	2	4998	1/32

300 mA

4113 97	6	2	4904	1/32
4113 98	10	2	4990	1/32
4113 99	16	2	4990	1/32
4114 00	20	2	4990	1/32
4114 01	25	2	4990	1/32
4114 02	32	2	5240	1/32

Double pole 240 V, HPI Type

30 mA

4114 15	25	2	9130	1/32
4114 16	32	2	9648	1/32

Four pole 415 V, AC Type

30 mA

4114 18	10	4	6474	1/16
4114 19	16	4	6474	1/16
4114 20	20	4	6474	1/16
4114 21	25	4	6474	1/16
4111 89	32	4	6474	1/16

Four pole 415 V, AC Type

300 mA

4114 23	10	4	7284	1/16
4114 24	16	4	7284	1/16
4114 25	20	4	7284	1/16
4114 26	25	4	7284	1/16
4112 08	32	4	7284	1/16

Four pole 415 V, A Type

30 mA

4114 28	10	4	7302	1/16
4114 29	16	4	7302	1/16
4114 30	20	4	7302	1/16
4114 31	25	4	7302	1/16
4112 37	32	4	7302	1/16

Four pole 415 V, A Type

300 mA

4114 33	10	4	7980	1/16
4114 34	16	4	7980	1/16
4114 35	20	4	7980	1/16
4114 36	25	4	7980	1/16
4112 42	32	4	7980	1/16

DX³ RCD add on module

For 125 A

Conform to IEC 61009-1
AC type : detect AC components faults
Hpi type : detect faults with AC and DC components, increased
Immunity to false tripping
For mounting on the right-hand side of 1.5 module per pole DX³ MCBs
Easy & fast association mechanism
Terminal cover for locking
70 sq mm terminals

Double pole 240 V, AC Type

30 mA

4105 68	125 A	4	14694	1
---------	-------	---	-------	---

100 mA

4105 69	125 A	4	16566	1
---------	-------	---	-------	---

300 mA

4105 71	125 A	4	16566	1
---------	-------	---	-------	---

Bold Cat.Nos are products normally available with Legrand (India) Stockists. Cat.Nos that are not bold - delivery within 4 - 8 weeks from the date of order. Bold packing quantity is our mandatory packing. Orders to be placed by Legrand (India) Stockist in multiples of the same.



4113 24



4113 94



4111 89



4112 08



4112 42



4113 79



4105 68

DX³ RCD add on module

Cat.Nos	Nominal Rating	Number of 17.5 mm modules	MRP* ₹ / Unit	Pack
---------	----------------	---------------------------	---------------	------

Four pole 415 V, AC Type

30 mA

4106 25	125 A	4	23192	1
---------	-------	---	-------	---

100 mA

4106 26	125 A	4	25916	1
---------	-------	---	-------	---

300 mA

4106 29	125 A	4	25916	1
---------	-------	---	-------	---

Double pole 240 V, HPI type

30 mA

4105 78	125 A	6	18702	1
---------	-------	---	-------	---

100 mA

4105 79	125 A	6	20904	1
---------	-------	---	-------	---

300 mA

4105 82	125 A	6	20904	1
---------	-------	---	-------	---

Four pole 415 V, HPI type

30 mA

4106 38	125 A	6	32060	1
---------	-------	---	-------	---

100 mA

4106 39	125 A	6	33932	1
---------	-------	---	-------	---

300 mA

4106 42	125 A	6	33932	1
---------	-------	---	-------	---

DX³ auxiliaries

Auxiliaries common for MCBs, Isolators, RCCBs & RCBOs

Easy & fast fixation on site
On site clip on mounting
Clip on fitting on left side

Cat.Nos	Description	Number of 17.5 mm modules	MRP* ₹ / Unit	Pack
---------	-------------	---------------------------	---------------	------

Signalling auxiliaries

4062 50	Auxiliary changeover switch 6 A	0.5	922	1
4062 52	Fault signalling changeover switch 6 A	0.5	1082	1
4062 64	Changeover + fault signalling switch	1	1738	1

Control auxiliaries

4062 76	Shunt release 12 /48 V AC/DC	1	2428	1
4062 78	Shunt release 110/415 V V AC	1	2428	1
4062 80	Undervoltage release 24/48 V AC/DC	1	2050	1
4062 82	Undervoltage release 230 V AC	1	2050	1

DX³ auxiliaries

Cat.Nos	Description	Number of 17.5 mm modules	MRP* ₹ / Unit	Pack
---------	-------------	---------------------------	---------------	------

Control auxiliaries

4062 86	Pop over voltage release	1	2660	1
4062 90	Motor control 24-48 V~/=	1	12116	1
4062 91	Motor control 230 V~	1	9778	1
4062 93	Motor control with automatic resetting 24-48 V~/=	2	21782	1
4062 95	Motor control with automatic resetting 230 V~	2	21782	1
4062 88	Stop and go automatic resetting 230 V~	2	9876	1
4062 89	Stop and go automatic resetting with self test unit 230 V~	2	14522	1

Rotary handle

4063 19	Black rotary handle	-	1936	10
4063 20	Yellow/red rotary handle	-	2178	10

Support for padlock

4063 03	Support for padlock till 63 A	-	466	10
---------	-------------------------------	---	-----	----

Sealable screw cover

4063 04	Devices upto 63 A	-	460	10
4063 06	For 80-125 A devices	-	5034	10

1/2 module spacing unit

4063 07	1/2 module spacing unit	0.5	170	10
---------	-------------------------	-----	-----	----

5 mm padlock

4063 13	5 mm Padlock	-	383	10
---------	--------------	---	-----	----

Manual changover switch

Compact design
Manual switching operation
Easy to assemble
Ergonomic design

For 1 mod/pole devices

4063 14	Manual change-over switch for DP	1	2308	5
4063 15	Manual change-over switch for TP	1	2664	5
4063 16	Manual change-over switch for FP	1	2904	5



4105 78



4062 50



4062 52



4062 78



4062 82

* MRP - Maximum Retail Price Inclusive of all taxes including GST.

Bold Cat.Nos are products normally available with Legrand (India) Stockists. Cat.Nos that are not bold - delivery within 4 - 8 weeks from the date of order. Bold packing quantity is our mandatory packing. Orders to be placed by Legrand (India) Stockist in multiples of the same.

DX³ RCD add on module with measurement & metering

Cat.Nos	Nominal Rating	Number of 17.5 mm modules	MRP* ₹ / Unit	Pack
---------	----------------	---------------------------	------------------	------

Conform to IEC 61009-1
Hpi type: detect faults with AC and DC components, increased
Immunity to false tripping
Inbuilt measurement/metering option
Measurement - V, A, F, PF, kWh, KVA, KVAh, THD
Metering - V, A, F, kWh
RS 485 port for remote reading
Di-electric test button inbuilt
Ergonomic test button
Scroll button for easy readings
RLCD display on front facia
For mounting on the right-hand side of 1.5 module per pole DX³ MCBs
Easy & fast association mechanism
70 sq mm terminals

Adjustable metering, four pole 415 V

4106 57	63 A	7	16062	1
4106 58	125 A	7	29440	1

Adjustable measurement

4106 59	125 A	7	32424	1
---------	-------	---	-------	---

DX³ time switches

Cat.Nos	Description	MRP* ₹ / Unit	Pack
---------	-------------	------------------	------

Time switches

Alpharex³ digital time switches

Daily and weekly time switch
Quick and easy programming due to the option to select day blocks, day blocks can be individually set or selected from the blocks Mon-Sun, Mon-Fri or Sat-Sun
Programming with precision to the second
Switch times visible in weekly overview on display

4126 31	AlphaRex ³ D21, 1 channel	4924	1
4126 41	AlphaRex ³ D22, 2 channels	7386	1
4126 34	AlphaRex ³ D21s, 1 channel	5744	1

Alpharex³ digital time switches - Astro

- For switching on/off lights and other electric devices according to the rising/setting of the sun
- With combination function for creating switching programs in which the devices are switched according to astronomical time and/or fixed preset times
- Daily astronomical calculation of the sunrise/sunset times based on the entered location or location coordinates

4126 54	AlphaRex ³ D21 astro, 1 channel	9834	1
4126 57	AlphaRex ³ D22 astro, 2 channels	11222	1

Alpharex³ yearly time switch

- Yearly and weekly time switch with additional astronomical function for all channels
- 84 switching programs per channel, comprising:
 - 28 weekly programs
 - 28 yearly programs
 - 28 special programs (priority program)

4126 29	AlphaRex ³ DY21, 1 channel	25830	1
4126 30	AlphaRex ³ DY22, 2 channels	26572	1

* MRP - Maximum Retail Price Inclusive of all taxes including GST.

DX³ time switches

Cat.Nos	Description	MRP* ₹ / Unit	Pack
---------	-------------	------------------	------

Programming accessories

4128 72	Data key	1392	1
4128 73	PC adapter for USB port	4788	1

Twilight switches

- Light sensitive switches
- Can be used to switch a lighting circuit "ON" and "OFF" based on light conditions (nightfall, daybreak)
- Supplied with IP 65 weatherproof photoelectric cell
- Adjustable from 1 to 100 000 lux

4126 23	Luxo Switch / Light sensitive switch with Lux Sensor - Output 16 A 250 V~	6458	1
---------	---------------------------------------------------------------------------	------	---

MicroRex analog time switches

In accordance with IEC 60730-1 and 60730-2-7
Manual switching ON/automatic/OFF
Hourly/daily/weekly switching dial with captive segments
Clock precision: +/- 5 min for the daily time switch
-10 °C to +55 °C operating temperature

4128 23	MicroRex T31 Su/Wi - Daily time switch	6038	1
4128 28	MicroRex W31 Su/Wi - Weekly time switch	6460	1

MicroRex analog time switches

4128 12	MicroRex T31 - Daily time switch	4972	1
4128 13	MicroRex QT31 - Daily time switch	5418	1
4128 14	MicroRex W31 - Weekly time switch	5798	1
4127 90	MicroRex QT11 - Daily time switch	3416	1
4127 94	MicroRex QW11 - Weekly time switch	3980	1

Accessory

4128 59	Wall bracket	984	1
---------	--------------	-----	---

DX³ contactors

Power contactors CX³

Conform to IEC/EN 61095

Space for power supply busbar on top (up to 25 A)

4125 44	25 A 2 NO contactor	2000	1
4125 45	40 A 2 NO contactor	3420	1
4125 47	63 A 2 NO contactor	3976	1
4125 48	63 A 2 NC contactor	3976	1
4125 49	40 A 3 NO contactor	5716	1
4125 50	63 A 3 NO contactor	6464	1
4125 51	25 A 4 NO contactor	2362	1
4125 53	40 A 4 NO contactor	6030	1
4125 56	63 A 4 NO contactor	7142	1
4125 57	63 A 4 NC contactor	7210	1

Signalling auxiliaries for contactors

Auxiliary changeover switch

4124 29	For 1 module contactors 16 A to 25 A	3020	1
4124 30	For 2 module contactors 25 A	3030	1
4124 31	For 40 and 63 A contactors	3976	1

Bold Cat.Nos are products normally available with Legrand (India) Stockists. Cat.Nos that are not bold - delivery within 4 - 8 weeks from the date of order. Bold packing quantity is our mandatory packing. Orders to be placed by Legrand (India) Stockist in multiples of the same.



4106 57



4128 12



4128 14



4126 41



4126 54



4126 57



4125 44



4126 29

DX³ for photovoltaic applications

Cat.Nos	Description	MRP* ₹ / Unit	Pack
---------	-------------	------------------	------

DC MCBs

Breaking capacity 4.5 kA according to EN 60947-2

800 V_{DC} circuit breakers

4144 24	6 A	■	1
4144 25	8 A	■	1
4144 26	10 A	■	1
4144 27	13 A	■	1
4144 28	16 A	■	1
4144 29	20 A	■	1

1000 V_{DC} circuit breakers

4144 46	10 A	■	1
4144 47	13 A	■	1
4144 48	16 A	■	1
4144 49	20 A	■	1
4144 50	25 A	■	1
4144 51	32 A	■	1



4122 57

Type II SPDs for Photovoltaic Application

DC side protection of photovoltaic installations connected to the low voltage network (without energy storage system)
Conforming to UTE guide C 61-740-51
Protection in common mode and residual current mode (Y mode) 1
Consisting of plug-in modules with LED indicator
Red: modules need to be replaced

Voltage surge protectors

Type II I_{max} = 40kA

4141 55	600 V= 25KA I _{max}	■	1
4141 56	1000 V 40KA I _{max}	■	1

Plug-in replacement module

4141 85	cassette for voltage surge protector 4141 55	■	1
4141 86	cassette for voltage surge protector 4141 56	■	1



4122 83

DC rotary handle isolating switches

Category of use DC 21B according to EN 60947-3
Double break contacts

600 V_{DC} isolating switches

4142 61	16 A	■	1
4142 62	25 A	■	1
4142 63	32 A	■	1



4123 03

1000 V_{DC} isolating switches

4142 81	16 A	■	1
4142 82	25 A	■	1
4142 83	32 A	■	1



4122 84

Accessories

4063 05	Pole separation divider	■	1
4063 07	Spacing unit 0.5 unit	■	10

■ Price available on request.

* MRP - Maximum Retail Price Inclusive of all taxes including GST.

¹ 1P+N and 3P+N: L-N and N-PE protection modes (common and differential modes), the N pole being protected by encapsulated spark gaps. Also called sometimes 1+1 and 3+1

² Replaced mid 2015 by Cat.No 4122 80

Class I (T1) low voltage SPDs

Cat.Nos	Number of poles	Neutral position	Rated (10/350)	Remote switching (ULCS contact)	Number of modules	MRP* ₹ / Unit	Pack
---------	-----------------	------------------	----------------	---------------------------------	-------------------	------------------	------

SPDs for general protection of main distribution board

T1+T2 - limp 12,5 kA/pole I_{max} - 60 kA

4122 70	1P	-	12.5 kA	No	1	7526	1
4122 76 ¹	1P+N	Right	25 kA	Yes	2	15050	1
4122 71	2P	-	25 kA	No	2	14536	1
4122 72	3P	-	37.5 kA	Yes	3	20478	1
4122 77 ¹	3P+N	Right	50 kA	Yes	4	27438	1
4122 73	4P	-	50 kA	No	4	25116	1

T1+T2 - limp 8 kA/pole I_{max} - 60 kA

4122 50	1P	-	8 kA	No	1	7146	1
4122 56 ¹	1P+N	Right	16 kA	No	2	12996	1
4122 51	2P	-	16 kA	No	2	13806	1
4122 52	3P	-	25 kA	No	3	19452	1
4122 57 ¹	3P+N	Right	25 kA	No	4	23640	1
4122 53	4P	-	32 kA	No	4	25054	1

T1 + T2 - limp 35 kA/pole - 440 V AC (IT) - Plug-in

4122 80	1P	-	35 kA	Yes	2	6664	1
---------	----	---	-------	-----	---	------	---

T1 + T2 - limp 25 kA/pole

4122 81 ¹	1P+N	Right	50 kA	Yes	4	8658	1
4122 82	3P	-	75 kA	Yes	6	45000	1
4122 83 ¹	3P+N	Right	100 kA	Yes	8	49498	1

Replacement plug-in modules

Cat.Nos	Description	MRP* ₹ / Unit	Pack
---------	-------------	------------------	------

4123 02	For SPDs T1+T2 - 8 kA Cat.Nos 4122 50/ 51/52/53/56/57	5972	1
4123 03	For SPDs T1+T2 - 12.5 kA Cat.Nos 4122 70/ 71/72/73/76/77	5632	1
4122 84	For SPDs T1 - 25 kA Cat.Nos 4122 81/82/83 and 0030 20/22/23/27	16212	1
4122 85	N-PE module for SPDs T1 - 25 kA Cat.Nos 4122 81/83 and 0030 23	22002	1
4122 86	For SPDs T1 - 35 kA Cat.No 4122 80	5438	1

Cabling accessories

4123 10	Ready to use cabling kit consisting of 5 conductors (including the earth conductor) Cross section :16 mm ² Length : 40 cm For cabling SPDs in industrial enclosures (for EN/IEC 61439 compliance).	1164	1
---------	------------------------------------------------------------------------------------------------------------------------------------------------------------------------------------------------------------------------	------	---

Bold Cat.Nos are products normally available with Legrand (India) Stockists. Cat.Nos that are not bold - delivery within 4 - 8 weeks from the date of order. Bold packing quantity is our mandatory packing. Orders to be placed by Legrand (India) Stockist in multiples of the same.

Class II (T2) low voltage SPDs

Cat.Nos	Number of poles	Neutral position	Remote status monitoring (FS contact)	Number of modules	MRP* ₹ / Unit	Pack
---------	-----------------	------------------	---------------------------------------	-------------------	---------------	------

T2 SPDs

T2 - I_{max} 40 kA/pole

4122 40	1P	-	No	1	5164	1
4122 46 ¹	1P+N	Right	No	2	9832	1
4122 41	2P	-	No	2	9832	1
4122 42	3P	-	Yes	3	14400	1
4122 47 ¹	3P+N	Right	No	4	17526	1
4122 43	4P	-	No	4	17526	1



4122 43

T2 - I_{max} 40 kA/pole - 440 V_~ (IT)

4122 30	1P	-	No	1	6838	1
4122 32	3P	-	Yes	3	20478	1
4122 33	4P	-	Yes	4	25116	1

T2 - I_{max} 20 kA/pole

4122 20	1P	-	No	1	3528	1
4122 26 ¹	1P+N	Right	No	2	7692	1
4122 21	2P	-	No	2	7692	1
4122 27 ¹	3P+N	Right	No	4	14320	1
4122 23	4P	-	No	4	14320	1

Replacement plug-in modules

Cat.Nos	Description	MRP* ₹ / Unit	Pack
---------	-------------	---------------	------

4122 99	For SPDs T2 - 40 kA Cat.Nos 4122 40/ 41/42/43/44/45/ 46/47/66/67	3844	1
4123 00	N-PE module for SPDs T2 - 40 kA Cat.Nos 4122 46/47	7692	1
4123 01	For SPDs T2 - 440 V Cat.Nos 4122 30/32/33	5916	1
4122 97	For SPDs T2 - 20 kA Cat.Nos 4122 20/ 21/23/26/27/62/63	2906	1
4123 98	N-PE module for SPDs T2 - 20 kA Cat.Nos 4122 24/25/26/27	6428	1



4122 99

* MRP - Maximum Retail Price Inclusive of all taxes including GST.

¹ 1P+N and 3P+N: L-N and N-PE protection modes (common and differential modes), the N pole being protected by encapsulated spark gaps. Also called sometimes 1+1 and 3+1

Class II (T2) low voltage SPDs with integrated protection

Cat.Nos	Number of poles	Neutral position	Integrated protection	Number of modules	MRP* ₹ / Unit	Pack
---------	-----------------	------------------	-----------------------	-------------------	---------------	------

Protection for consumer units

T2 self protected SPDs - I_{max} 12 kA/pole

0039 51 ¹	1P+N	Left	I _{sc} ≤ 6 kA	2	9970	1
0039 53 ¹	3P+N	Left	I _{sc} ≤ 6 kA	6	21750	1



0039 51



0039 53

Protection for secondary distribution boards

T2 self protected SPDs - I_{max} 12 kA/pole

0039 71 ¹	1P+N	Left	I _{sc} ≤ 10 kA	2	8254	1
0039 73 ¹	3P+N	Left	I _{sc} ≤ 10 kA	6	15614	1

Replacement plug-in modules

Cat.Nos	Description	MRP* ₹ / Unit	Pack
---------	-------------	---------------	------

For self protected SPDs

0039 54	Cat.Nos 0039 51/53	6470	1
0039 74	Cat.Nos 0039 71/73	6692	1



0039 54

SPDs for telephone lines

Cat.Nos	In/I _{max}	Max. voltage (Uc)	Level of protection (Up)	No. of modules	MRP* ₹ / Unit	Pack
---------	---------------------	-------------------	--------------------------	----------------	---------------	------

SPDs for telephone and data lines

"Analogue" SPD (STN, non-unbundled ADSL, etc.)

0038 28	5/10 kA	170 V	260 V	1	12282	1
---------	---------	-------	-------	---	-------	---



0038 28

"Digital" SPD (unbundled ADSL, SDSL, ISDN, etc.)

0038 29	5/10 kA	48 V	100 V	1	12262	1
---------	---------	------	-------	---	-------	---



0038 29

DX³ changeover switches

Cat.Nos	Description	MRP* ₹ / Unit	Pack
---------	-------------	---------------	------

Changeover Switches

Single pole - two way - 250 V AC

4129 00	32 A	3174	10/100
---------	------	------	--------

Double pole - two way - 400 V AC

4129 01	32 A	3174	5/50
---------	------	------	------

Double pole - two way with centre off - 400 V AC

4129 03	32 A	3324	5/50
---------	------	------	------

Four pole - two way with centre off - 400 V AC

6040 22	40 A	5024	2/20
---------	------	------	------



4129 00



6040 22

Bold Cat.Nos are products normally available with Legrand (India) Stockists. Cat.Nos that are not bold - delivery within 4 - 8 weeks from the date of order. Bold packing quantity is our mandatory packing. Orders to be placed by Legrand (India) Stockist in multiples of the same.

ACCL

AUTOMATIC CHANGEOVER WITH CURRENT LIMITER

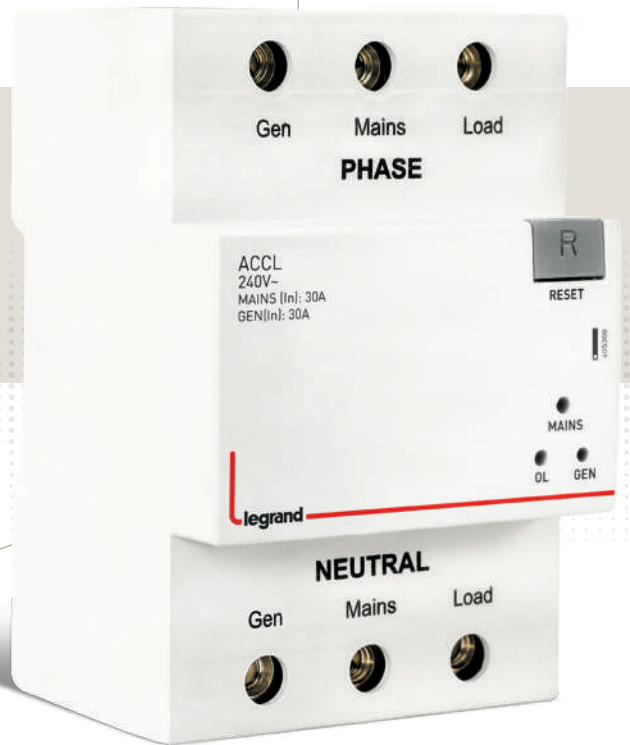

Seamless and uninterrupted switchover for smart spaces

→ Intelligent micro-controller based design

→ Automatic source change over between Mains & Generator supply

→ Manual reset for restoring supply in sleep mode

→ Break before make change over system

→ Direct mount on DIN rail channel

→ Buzzer and LED light indication of status-Overload, Mains, Gen

→ Current limitation function prevents over loading of the generator

→ Neutral isolation

Automatic changeover with current limiter(ACCL)

NEW!

Automatic changeover with current limiter(ACCL)

Intelligent micro controller based design
Automatic source change over between Mains & Generator supply
Break before make change over system
Buzzer and Led Indication of status
Current limitation prevents overloading of the generator

Cat.Nos	Description	MRP* ₹ / Unit	Pack
4053 00	SPN 30/3A	2176	1/15
4053 01	SPN 30/4A	2176	1/15
4053 02	SPN 30/5A	2176	1/15
4053 03	SPN 30/6A	2176	1/15
4053 04	SPN 30/9A	2176	1/15
4053 05	SPN 30/12A	2176	1/15
4053 06	SPN 30/15A	2176	1/15
4053 07	SPN 30/20A	2176	1/15
4053 08	SPN 30/30A	2176	1/15

DX³ push button

Push button cum switch

Push button cum switch - 1 module - 20 A-250 V AC

Single function

Cat.Nos	Description	MRP* ₹ / Unit	Pack
4129 08	Contact 1 NO	2688	10/100
4129 09	Contact 1 NC	2688	10/60
4129 10	Contact 2 NO	2688	10/60

Dual function

4129 14	Contact - 1 NO + green indicator	2688	10/100
4129 15	Contact - 1 NC + red indicator	2688	10/60

DX³ indicators

Single indicators - 1 module - 250 V AC

Possible to replace E10 lamps and diffusers.
E10 - 1.2 Watt, 230 V AC

4129 26	Colour - Green	694	10/100
4129 27	Colour - Red	694	10/100
4129 28	Colour - Orange	694	10/100
4129 29	Colour - Blue	694	10/100
4129 32	White + White + White	1344	10/100
4129 33	Red + Red + Red time delay relay	1344	10/100
4129 34	Red + Yellow + Green	1370	10/100
4129 35	Red + Yellow + Blue	1384	10/100

Lexic dimmer

Dimmer

1000 W remote dimmer

0036 71	1000 W universal remote control dimmer 6 module	43126	1/10
---------	-------------------------------------------------------	-------	------

Lexic time switches

Multifunction time delay relay

- Supply voltage : 12 to 230 V AC 50/60 Hz and DC
- Output : 8 A - 250 V AC, $\cos\phi = 1$
- Contact NO

0047 44	Multifunction time delay relay	12878	1
---------	-----------------------------------	-------	---

* MRP - Maximum Retail Price Inclusive of all taxes including GST.

Rex modular time switches

Cat.Nos	Description	MRP* ₹ / Unit	Pack
---------	-------------	------------------	------

Time lag switch

0047 02	Time lag switch long time (1 module)	6706	10/100
---------	-----------------------------------------	------	--------

Rex surface mounting time switches

MaxiRex

6499 15	MaxiRex 4QT (daily)	5682	1/30
6499 14A	MaxiRex 4QTB (daily with IP 53 box)	6508	1
6499 39	MaxiRex 5QW (weekly)	6298	1/30
6499 36A	MaxiRex 4QWB (weekly with IP 53 box)	6828	1

EconoRex

0499 86	EconoRex MQT (24 hrs.)	5652	1/30
---------	------------------------	------	------

Accessories

0498 32	Clip on support frame for facia mounting of MaxiRex QTT and QWT	344	1/5
0044 09	DIN rail adaptor for MaxiRex QTT and QWT	262	1
0044 07	DIN rail adaptor for EconoRex BQTAP	252	1
6499 49	Terminal cover for 4/5 nominal time switch	290	1/30
6499 48	IP53 box for MaxiRex 4 and 5	882	1/10

Current transformers

- Used with ammeters, electricity meters
- Supply a current of 5 A to the secondary which is proportional to the primary current.
- Fix to plate or rail EN 60715

4121 01	50/5 Precision in % - 1 Power in VA - 1.5	2718	1/12
4121 03	100/5 Precision in % - 1 Power in VA - 1.5	3630	1/12
4121 06	200/5 Precision in % - 0.5 Power in VA - 4	3630	1/12
4121 24	300/5 Precision in % - 0.5 Power in VA - 5	3630	1/12
4121 25	400/5 Precision in % - 0.5 Power in VA - 8	3760	1/12
4121 36	600/5 Precision in % - 0.5 Power in VA - 12	3814	1/12
4121 38	800/5 Precision in % - 0.5 Power in VA - 8	5588	1/12
4121 39	1000/5 Precision in % - 0.5 Power in VA - 10	5906	1/12
4121 42	1250/5 Precision in % - 0.5 Power in VA - 12	6888	1/12

Bold Cat.Nos are products normally available with Legrand (India) Stockists.
Cat.Nos that are not bold - delivery within 4 - 8 weeks from the date of order.
Bold packing quantity is our mandatory packing. Orders to be placed by Legrand (India) Stockist in multiples of the same.



4129 08



4129 15



4129 27



0036 71



0047 44



EKINOX³

REINVENTED ENERGY DISTRIBUTION

Ekinox³ is an experience unlike any other. Imagine a distribution board built with incredible features which keep you away from the worry of constantly maintaining it. Ekinox³ is designed to work as beautifully as it looks.



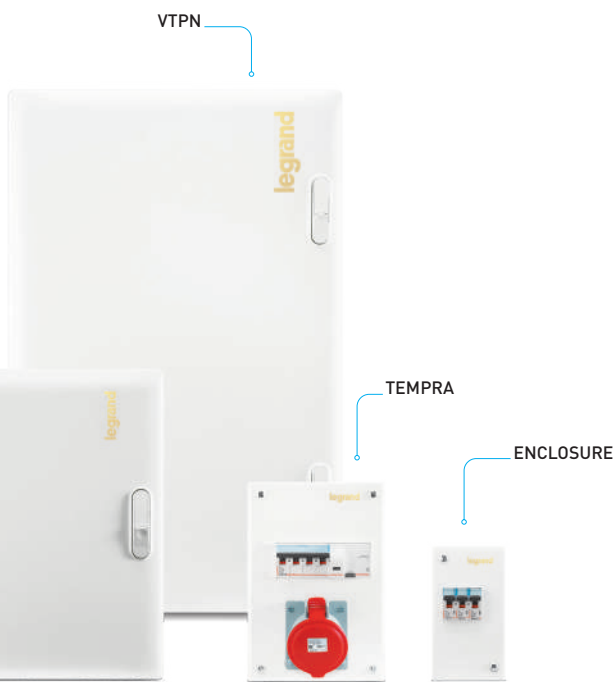

Ekinox³ SPN DB's

for DX³ MCB, Isolator, RCCB and RCBO

Cat.Nos	Number of ways	No. of modules	MRP* ₹ / Unit	Pack
---------	----------------	----------------	------------------	------

- As per IEC 61439-3
- Suitable for Flush Mounting and Surface Mounting
- With 100 A Copper Busbar
- With Neutral bar, Earthbar and Cable ties for Cable management
- Fully shrouded Neutral bars
- Prefitted masking sheet
- Reversible Door for IP 43 & IP 54 DB's

IP 30 - #IK 08

5076 00	4 way	4	1336	1
5076 01	8 way	8	1646	1
5076 02	12 way	12	1928	1
5076 03	16 way	16	2354	1
5076 04	18 way	18	2714	1
5076 05	20 way	20	2788	1



5076 05



5076 82

IP 43 - #IK 09 with metal door

5076 10	4 way	4	1796	1
5076 11	8 way	8	2196	1
5076 12	12 way	12	2638	1
5076 13	16 way	16	3358	1
5076 14	18 way	18	3424	1
5076 15	20 way	20	4154	1



5076 12

IP 43 - #IK 09 with acrylic door

5076 20	4 way	4	2334	1
5076 21	8 way	8	2704	1
5076 22	12 way	12	3284	1
5076 23	16 way	16	4082	1
5076 24	18 way	18	4350	1
5076 25	20 way	20	4606	1

IP 54 - #IK 09

5076 40	4 way	4	6074	1
5076 41	8 way	8	7208	1
5076 42	12 way	12	8278	1
5076 43	16 way	16	9212	1
5076 44	18 way	18	9404	1
5076 45	20 way	20	10220	1



5076 42

Ekinox³ ETPN DB's

for DX³ MCB, Isolator, RCCB and RCBO

- As per IEC 61439-3
- Suitable for Flush Mounting and Surface Mounting
- With 100 A Copper Busbar for each phase
- With Neutral bar, Earthbar and Cable ties for Cable management
- Fully insulated busbar & shrouded Neutral bars
- Improved Pan assembly for ease of installation
- Prefitted masking sheet
- Reversible Door for IP 43 & IP 54 DB's
- With provision for FP MCB/Isolator/RCCB/RCBO as incomer and SP MCB's as outgoing
- Supplied with wireset
- Can be converted to PPI DB at site using conversion kit

IP 30 - #IK 08

5076 60	4 way	8+12	3690	1
5076 61	6 way	8+18	4554	1
5076 62	8 way	8+24	5354	1
5076 63	12 way	8+36	7706	1
5076 64	16 way	8+48	9498	1
5076 66	20 way	8+60	13126	1



5077 01



5077 11

Ekinox³ ETPN DB's

for DX³ MCB, Isolator, RCCB and RCBO

Cat.Nos	Number of ways	No. of modules	MRP* ₹ / Unit	Pack
---------	----------------	----------------	------------------	------

IP 43 - #IK 09 with metal door

5076 70	4 way	8+12	4386	1
5076 71	6 way	8+18	5410	1
5076 72	8 way	8+24	6490	1
5076 73	12 way	8+36	9720	1
5076 74	16 way	8+48	12050	1
5076 76	20 way	8+60	16868	1

IP 43 - #IK 09 with acrylic door

5076 80	4 way	8+12	5814	1
5076 81	6 way	8+18	7042	1
5076 82	8 way	8+24	8368	1
5076 83	12 way	8+36	12836	1
5076 84	16 way	8+48	15340	1
5076 86	20 way	8+60	21348	1

IP 54 - #IK 09

5076 90	4 way	8+12	14608	1
5076 91	6 way	8+18	17580	1
5076 92	8 way	8+24	19226	1
5076 93	12 way	8+36	27096	1
5076 94	16 way	8+48	32516	1
5076 96	20 way	8+60	38382	1

Ekinox³ Flexy DB

for DX³ DIN modular products

Cat.Nos	Number of row	No. of modules	MRP* ₹ / Unit	Pack
---------	---------------	----------------	------------------	------

- As per IEC 61439-3
- Suitable for Flush Mounting and Surface Mounting
- Completely flexible to organise the distribution as per site requirements
- Busbars to be selected as per distribution requirements
- With Neutral and Earth bars
- Fully shrouded Neutral bars
- Improved Pan assembly for ease of installation
- Prefitted masking sheet
- Reversible door for IP 43

IP 30 - #IK 08

5077 01	2 row of 14 M	28	4588	1
5077 02	3 row of 14 M	42	5666	1
5077 03	4 row of 14 M	56	6368	1

IP 43 - #IK 09 with metal door

5077 05	2 row of 14 M	28	5568	1
5077 06	3 row of 4 M	42	6686	1
5077 07	4 row of 14 M	56	7284	1
5077 14	4 row of 8 M	32	5796	1
5077 15	4 row of 10 M	40	6010	1
5077 12	3 row of 14 M MCCB for DPX ³ 160 MCCB	42	7282	1

IP 43 - #IK 09 with acrylic door

5077 09	2 row of 14 M	28	5776	1
5077 10	3 row of 14 M	42	7084	1
5077 11	4 row of 14 M	56	8026	1
5077 13	3 row of 14 M MCCB for DPX ³ 160 MCCB	42	8100	1

* MRP - Maximum Retail Price Inclusive of all taxes including GST.
#IK - Refer pg - 59 for ready reckoner table.

Bold Cat.Nos are products normally available with Legrand (India) Stockists.
Cat.Nos that are not bold - delivery within 4 - 8 weeks from the date of order.
Bold packing quantity is our mandatory packing. Orders to be placed by Legrand (India) Stockist in multiples of the same.

Ekinox³ TPN DB-VTPN DB's

for DX³ MCB, Isolator, RCCB and RCBO

Cat.Nos	Number of ways	No. of modules	MRP* ₹ / Unit	Pack
---------	----------------	----------------	------------------	------

- As per IEC 61439-3
- Suitable for Flush Mounting and Surface Mounting
- With 100 A Copper Busbar for each phase
- With 2 Neutral bar, 2 Earthbar and Cable ties for Cable management
- Fully insulated busbar & shrouded Neutral bars
- Improved Pan assembly for ease of installation
- Prefitted masking sheet
- Reversible Door for IP 43 & IP 54 DB's
- With provision for FP MCB/Isolator/RCCB/RCBO as incomer and SP/TP MCB's as outgoing

IP 30 - #IK 08

5077 20	4 way	8+12	10000	1
5077 21	6 way	8+18	10998	1
5077 22	8 way	8+24	12208	1
5077 23	12 way	8+36	17628	1

IP 43 - #IK 09 with metal door

5077 25	4 way	8+12	10922	1
5077 26	6 way	8+18	12016	1
5077 27	8 way	8+24	13892	1
5077 28	12 way	8+36	18872	1

IP 43 - #IK 09 with acrylic door

5077 30	4 way	8+12	14232	1
5077 31	6 way	8+18	15656	1
5077 32	8 way	8+24	18094	1
5077 33	12 way	8+36	24140	1

IP 54 - #IK 09

5077 35	4 way	8+12	22544	1
5077 36	6 way	8+18	24802	1
5077 37	8 way	8+24	27116	1
5077 38	12 way	8+36	35446	1

Ekinox³ TPN DB-VTPN DPX³ 160 MCCB DB's

- As per IEC 61439-3
- Suitable for Flush Mounting and Surface Mounting
- With 250 A Copper Busbar for each phase
- With 2 Neutral bar, 2 Earthbar and Cable ties for Cable management
- Fully insulated busbar & shrouded Neutral bars
- Improved Pan assembly for ease of installation
- Prefitted masking sheet
- Reversible Door for IP 43 & IP 54 DB's
- With provision for DPX³ 160 MCCB as incomer and SP/TP MCB's as outgoing

IP 30 - #IK 08

5077 40	4 way	DPX ³ 160+12	11308	1
5077 41	6 way	DPX ³ 160+18	12212	1
5077 42	8 way	DPX ³ 160+24	13382	1
5077 43	12 way	DPX ³ 160+36	20232	1

IP 43 - #IK 09 with metal door

5077 45	4 way	DPX ³ 160+12	13036	1
5077 46	6 way	DPX ³ 160+18	14810	1
5077 47	8 way	DPX ³ 160+24	16300	1
5077 48	12 way	DPX ³ 160+36	22222	1

* MRP - Maximum Retail Price Inclusive of all taxes including GST.
#IK - Refer pg - 59 for ready reckoner table.

Ekinox³ TPN DB-VTPN DPX³ 160 MCCB DB's

Cat.Nos	Number of ways	No. of modules	MRP* ₹ / Unit	Pack
---------	----------------	----------------	------------------	------

IP 54 - #IK 09

5077 50	4 way	DPX ³ 160+12	26456	1
5077 51	6 way	DPX ³ 160+18	30126	1
5077 52	8 way	DPX ³ 160+24	32728	1
5077 53	12 way	DPX ³ 160+36	43114	1

Ekinox³ TPN DB-VTPN DPX³ 250 MCCB DB's

- As per IEC 61439-3
- Suitable for Flush Mounting and Surface Mounting
- With 250 A Copper Busbar for each phase
- With 2 Neutral bar, 2 Earthbar and Cable ties for Cable management
- Fully insulated busbar & shrouded Neutral bars
- Improved Pan assembly for ease of installation
- Prefitted masking sheet
- Reversible Door for IP 43 & IP 54 DB's
- With provision for DPX³ 250 MCCB as incomer and SP/TP MCB's as outgoing

IP 30 - #IK 08

5077 55	4 way	DPX ³ 250+12	21210	1
5077 56	8 way	DPX ³ 250+24	22550	1
5077 57	12 way	DPX ³ 250+36	24888	1

IP 43 - #IK 09 with metal door

5077 58	4 way	DPX ³ 250+12	24134	1
5077 59	8 way	DPX ³ 250+24	28180	1
5077 60	12 way	DPX ³ 250+36	29702	1

IP 54 - #IK 09

5077 61	4 way	DPX ³ 250+12	36214	1
5077 62	8 way	DPX ³ 250+24	40900	1
5077 63	12 way	DPX ³ 250+36	47890	1

Ekinox³ TPN DB-Phase selector DB's for DX³ MCB, Isolator, RCCB and RCBO

- As per IEC 61439-3
- With inbuilt 3 nos of 63 A Phase selector switches and 3 Nos Piano Switches
- Suitable for Flush Mounting and Surface Mounting
- With 100 A Copper Busbar for each phase
- With Neutral bar, Earthbar and Cable ties for Cable management
- Fully insulated busbar & shrouded Neutral bars
- With provision for FP MCB/Isolator/RCCB/RCBO as incomer and SP MCB's as outgoing
- Supplied with wire set

IP 30 - #IK 08

5077 70	4 way	8+12	13176	1
5077 71	6 way	8+18	14014	1
5077 72	8 way	8+24	15526	1
5077 73	12 way	8+36	17194	1

IP 43 - #IK 09 with metal door

5077 80	4 way	8+12	15108	1
5077 81	6 way	8+18	15348	1
5077 82	8 way	8+24	16444	1
5077 83	12 way	8+36	18512	1

Bold Cat.Nos are products normally available with Legrand (India) Stockists. Cat.Nos that are not bold - delivery within 4 - 8 weeks from the date of order. Bold packing quantity is our mandatory packing. Orders to be placed by Legrand (India) Stockist in multiples of the same.

Ekinox³ TPN DB - 7 segment DB's for DX³ MCB, Isolator, RCCB and RCBO

Cat.Nos	Number of ways	No. of modules	MRP* ₹ / Unit	Pack
---------	----------------	----------------	------------------	------

- As per IEC 61439-3
- Separate compartment for incomer, sub-incomer & outgoing devices
- Suitable for Flush Mounting and Surface Mounting
- With 100 A Copper Busbar for each phase
- With Neutral bar, Earthbar and Cable ties for Cable management
- Fully insulated busbar & shrouded Neutral bars
- With provision for FP MCB/Isolator/RCCB/RCBO as incomer, DP RCCB/RCBO as sub incomer and SP MCB's as outgoing
- Supplied with wire set
- DB with phase segmentation and separation between incomer and outgoing

IP 30 - #IK 08

5078 80	4 way	8+12+12	9996	1
5078 81	6 way	8+12+18	10588	1
5078 82	8 way	8+12+24	11506	1
5078 83	12 way	8+12+36	13216	1

IP 43 - #IK 09 with metal door

5078 85	4 way	8+12+12	11284	1
5078 86	6 way	8+12+18	12710	1
5078 87	8 way	8+12+24	14192	1
5078 88	12 way	8+12+36	17644	1

Ekinox³ TPN DB - 7 segment DB's for 160 A DPX³ MCCB

- As per IEC 61439-3
- DB with phase segmentation and separation between incomer and Outgoing
- Suitable for Flush Mounting and Surface Mounting
- With 100 A Copper Busbar for each phase
- With Neutral bar, Earthbar and Cable ties for Cable management
- Fully Color Shrouded Insulated bus bar and Neutral bars
- With provision for DPX³ 160 MCCB as incomer DP MCB/Isolator/RCCB/RCBO as sub incomers and SP MCB's as outgoing
- Supplied with wire set

IP 30 - #IK 08

5078 90	4 way	DPX ³	14008	1
	160+12+12			
5078 91	6 way	DPX ³	16116	1
	160+12+18			
5078 92	8 way	DPX ³	18520	1
	160+12+24			
5078 93	12 way	DPX ³	21502	1
	160+12+36			

* MRP - Maximum Retail Price Inclusive of all taxes including GST.
#IK - Refer pg - 59 for ready reckoner table.

Ekinox³ TPN DB - 7 segment DB's for 160 A DPX³ MCCB

Cat.Nos	Number of ways	No. of modules	MRP* ₹ / Unit	Pack
---------	----------------	----------------	------------------	------

IP 43 - #IK 09 with metal door

5078 95	4 way	DPX ³	15500	1
	160+12+12			
5078 96	6 way	DPX ³	17742	1
	160+12+18			
5078 97	8 way	DPX ³	20514	1
	160+12+24			
5078 98	12 way	DPX ³	23138	1
	160+12+36			

Ekinox³ Metra plug & socket DB's for DX³ MCB, RCCB and RCBO

Cat.Nos	Description	No. of modules	MRP* ₹ / Unit	Pack
---------	-------------	----------------	------------------	------

- As per IEC 61439-3
- Suitable for Flush Mounting and Surface Mounting
- Suitable for protection of appliances like AC/Geysers etc
- Supplied with Neutral Links
- With provision for mounting modular devices

#IK 08

5078 10	10 A SP, 2P+E	1	1740	1
5078 11	20 A SP, 2P+E	1	1876	1
5078 14	20 A DP, 2P+E	2	2038	1
5078 17	20 A TP, 3P+E	3	3454	1
5078 18	32 A TP, 3P+E	3	4098	1
5078 20	20 A DP RCBO, 2P+E	4	1972	1
5078 21	20 A FP RCBO, 2P+E	8	3448	1
5078 22	32 A FP RCBO, 3P+E	8	4066	1

Ekinox³ P-17 Tempra plug & socket DB's for DX³ MCB, RCCB and RCBO

- As per IEC 61439-3
- Suitable for Flush Mounting and Surface Mounting
- Supplied with Neutral Links
- With provision for mounting modular devices

#IK 08

5078 60	16 A 2P+E-DP	2	2874	1
5078 63	32 A 2P+E-DP	2	3102	1
5078 61	32 A 3P+E-FP	8	5198	1
5078 62	32 A 3P+N+E-FP	8	5258	1
5078 64	63 A 3P+N+E-FP	8	13084	1

Bold Cat.Nos are products normally available with Legrand (India) Stockists. Cat.Nos that are not bold - delivery within 4 - 8 weeks from the date of order. Bold packing quantity is our mandatory packing. Orders to be placed by Legrand (India) Stockist in multiples of the same.



5078 95



5078 86



5078 14



5078 22



5078 60



5078 62



5078 64

Ekinox³ Metal enclosures

for DX³ MCB, RCCB, RCBO and DPX³ MCCB's

Cat.Nos	Description	No. of modules	MRP* ₹ / Unit	Pack
---------	-------------	----------------	---------------	------

- As per IEC 61439-3
- For independent mounting of DX³ MCB, RCCB, RCBO, DPX³ 160, DPX³ 250, DPX³ 630 & DRX MCCB's
- #IK 08

#IK 08

5077 90	SP enclosure	1	478	1
5077 91	DP enclosure	2	696	1
5077 92	TP enclosure	3	696	1
5077 93	FP enclosure	4	696	1
5077 94	FP RCBO enclosure	8	1174	1

Metal one way enclosures for MCCB

5078 01	DPX ³ 160 MCCB enclosure	3&4	3912	1
5078 02	DPX ³ 250 MCCB enclosure	3&4	6948	1
5078 04	DPX ³ 630 MCCB enclosure	3&4	10532	1
5078 05	DRX 100 MCCB enclosure-TP	3	2090	1
5078 06	DRX 100 MCCB enclosure-FP	4	1972	1

Ekinox³ cable end box

Cat.Nos	Description	MRP* ₹ / Unit	Pack
---------	-------------	---------------	------

- Useful for keeping extra cables
- Possible to mount on the top or bottom of the DB
- Provision for mounting terminal blocks
- Can be used as a terminal box adaptor also

For IP 30 DB's

5079 10	For SPN 4 W IP30	676	1
5079 12	For SPN 8 W IP30	780	1
5079 14	For SPN 12 W/ VTPN/Flexy	854	1
5079 16	For SPN 16 W/ ETPN 6 way DB	1192	1
5079 25	For ETPN 8 way DB	2152	1
5079 27	For ETPN 12 way DB	2840	1
5079 29	For ETPN 16 way DB	2868	1
5079 31	For ETPN 18 way DB	3136	1
5079 33	For ETPN 20 way DB	3154	1
5079 35	For ETPN 4 way VTPN/FLEXY MCB	854	1
5079 37	For all VTPN MCCB DBS	3170	1

For IP 43 DB's

5079 11	For SPN 4 way DB	756	1
5079 13	For SPN 8 way DB	906	1
5079 15	For SPN 12 way/ VTPN/Flexy DB	1016	1

* MRP - Maximum Retail Price Inclusive of all taxes including GST.
#IK - Refer pg - 59 for ready reckoner table.

Ekinox³ cable end box

Cat.Nos	Description	MRP* ₹ / Unit	Pack
---------	-------------	---------------	------

For IP 43 DB's

5079 17	For SPN 16 way/ ETPN 6 way DB	1440	1
5079 18	For SPN 18 way DB	1472	1
5079 19	For SPN 20/ETPN 8 way DB	1508	1
5079 28	For ETPN 12 way DB	3264	1
5079 30	For ETPN 16 way DB	3294	1
5079 32	For ETPN 18 way DB	3622	1
5079 34	For ETPN 20 way DB	3622	1
5079 36	For all ETPN 4W/VTPN/Flexy MCB	1016	1
5079 38	For all VTPN MCCB DBs	3638	1
5079 00	For 7 segment 4 way DB	3324	1
5079 01	For 7 segment 6 way DB	3646	1
5079 02	For 7 segment 8 way DB	4068	1
5079 03	For 7 segment 12 way DB	4596	1

Ekinox³ DBs

meter box

- Suitable for Mounting DX³ Metering products
- Possible to mount on the top or bottom of the DB
- Provision for mounting Ammeter/Voltmeter/ASS/VSS
- #IK09

Provision for mounting meters

5079 40	For VTPN MCB INCOM IP 30	4274	1
5079 41	For VTPN MCB INCOM IP 43	5134	1
5079 42	For VTPN MCCB INCOM IP 30	4752	1
5079 43	For VTPN MCCB INCOM IP 43	5868	1

Per phase Isolation kit

5079 44	PPI conversion kit for ETPN 4 way DB	2502	1
5079 45	PPI conversion kit for ETPN 6 way DB	2820	1
5079 46	PPI conversion kit for ETPN 8 way DB	3262	1
5079 47	PPI conversion kit for ETPN 12 way DB	3638	1
5079 48	PPI conversion kit for ETPN 16 way DB	4086	1

Panel locks

5079 52	Panel knob for IP 43	280	1
5079 51	Panel knob with key	574	1

Bold Cat.Nos are products normally available with Legrand (India) Stockists. Cat.Nos that are not bold - delivery within 4 - 8 weeks from the date of order. Bold packing quantity is our mandatory packing. Orders to be placed by Legrand (India) Stockist in multiples of the same.

Ekinox™ distribution boards

Cat.Nos	Number of ways	MRP* ₹ / Unit	Pack
---------	----------------	------------------	------

Plexo3 boxes for DX³

Self-extinguishing: resistance to incandescent wire 650 °C

Conform to EN 60439-3

Weatherproof cabinets - IP 65 - IK 09 - Class II

Door and cabinet fully reversible

Removable chassis and faceplates from 2-row versions up

2-position rail for modular products and moulded cases

Spacing between rails 150 mm

Box colour light grey L750A, cover colour dark grey R746A



6019 94

6019 32	2 (+1) Module	1670	1
6019 94	4 Module	1780	1
6019 96	6 Module	2040	1
6019 98	8 Module	2550	1



6018 32

Cabinets with 12 modules per row

6018 31	1 row 12 modules	4018	1
6018 32	2 rows 24 modules	5572	1
6018 33	3 rows 36 modules	7766	1

Cabinets with 18 modules per row

6018 35	18 modules x 1 row	4954	1
6018 36	18 modules x 2 rows	8570	1
6018 37	18 modules x 3 rows	12052	1
6018 38	18 modules x 4 rows	18752	1



6018 32 + 0019 17

Multifunction sleeves for P17

0019 17	For 2 row cabinets	3248	1
0019 18	For 3 row cabinets	4868	1
0019 67	Joining kit	948	1

Ekinox³
reinvented
electrical safety

* MRP - Maximum Retail Price Inclusive of all taxes including GST.
Refer instruction manual for MIVAN (Aluminum shuttering) compatible DB's

Distribution boards

Cat.Nos	No. of devices connected	No. of 17.5 mm modules	MRP* ₹ / Unit	Pack
---------	--------------------------	------------------------	------------------	------

Supply busbars - insulated

63 A copper

Pin type

SP I/C & SP O/G

4049 26	13	13	330	1
4049 37	57	57	1280	1

SPN I/C & SPN O/G

4049 38	6	12	580	1
4049 39	28	56	2394	1

TPN I/C & SPN O/G

4049 40	5	12	596	3/30
4049 41	27	56	5848	5/10

TP I/C & TP O/G

4049 42	4	12	600	1
4049 43	19	57	5878	1

FP I/C & FP O/G

4049 44	3	12	1442	3/30
4049 45	14	56	5848	5/10

Fork type

SP I/C & SP O/G

4049 11	13	12	330	1
4049 12	57	57	1254	1

SPN I/C & SPN O/G250

4049 14	28	56	2394	1
---------	----	----	------	---

TP I/C & TP O/G

4049 17	4	12	596	1
4049 18	19	57	5848	1

FP I/C & FP O/G

4049 20	14	56	5848	5/10
---------	----	----	------	------

Cat.Nos	Description	MRP* ₹ / Unit	Pack
---------	-------------	------------------	------

Accessories for fork and pin type busbars

4049 89	End caps for SP	8	6
4049 90	End caps for DP & TP	38	6
4049 91	End caps for FP	72	20/840

Cat.Nos	Number of ways	MRP* ₹ / Unit	Pack
---------	----------------	------------------	------

Blanking plates

6014 70	-	14	10
---------	---	----	----

Bold Cat.Nos are products normally available with Legrand (India) Stockists. Cat.Nos that are not bold - delivery within 4 - 8 weeks from the date of order. Bold packing quantity is our mandatory packing. Orders to be placed by Legrand (India) Stockist in multiples of the same.

Ekinox³

For converting ETPN DB to PPI DB

PPI DB IP 30 - IK 08

No. of ways	Combine		No. of modules
	ETPN DB	PPI Kit	
4 way	4 way 507660	4 way kit 507944	8+12
6 way	6 way 507661	6 way kit 507945	8+18
8 way	8 way 507662	8 way kit 507946	8+24
12 way	12 way 507663	12 way kit 507947	8+36
16 way	16 way 507664	16 way kit 507948	8+48

PPI DB IP 43 - IK 09 with metal door

No. of ways	Combine		No. of modules
	ETPN DB	PPI Kit	
4 way	4 way 507670	4 way kit 507944	8+12
6 way	6 way 507671	6 way kit 507945	8+18
8 way	8 way 507672	8 way kit 507946	8+24
12 way	12 way 507673	12 way kit 507947	8+36
16 way	16 way 507674	16 way kit 507948	8+48

PPI DB IP 43 - IK 09 with acrylic door

No. of ways	Combine		No. of modules
	ETPN DB	PPI Kit	
4 way	4 way 507680	4 way kit 507944	8+12
6 way	6 way 507681	6 way kit 507945	8+18
8 way	8 way 507682	8 way kit 507946	8+24
12 way	12 way 507683	12 way kit 507947	8+36
16 way	16 way 507684	16 way kit 507948	8+48

PPI DB IP 54 - IK 09

No. of ways	Combine		No. of modules
	ETPN DB	PPI Kit	
4 way	4 way 507690	4 way kit 507944	8+12
6 way	6 way 507691	6 way kit 507945	8+18
8 way	8 way 507692	8 way kit 507946	8+24
12 way	12 way 507693	12 way kit 507947	8+36
16 way	16 way 507694	16 way kit 507948	8+48

IK

Protection against mechanical impact: protection index - IK

According to standard:

IEC 62262, BS EN 62262 and NF EN 62262

• This table can be used to ascertain the resistance of a product to an impact given in Joules from the IK code (graduated from 00 to 10)

It can also be used to ascertain the correspondence with the old IP code 3rd digit and the corresponding external "Ag" conditions

IK	Tests	Impact energy (in Joules)	"AG" of NF C 15-100
IK 00		0	
IK 01		0.15	
IK 02		0.2	AG1
IK 03		0.35	
IK 04		0.5	
IK 05		0.7	
IK 06		1	
IK 07		2	AG2
IK 08		5	AG3
IK 09		10	
IK 10		20	AG4

IPXX

Index of protection

IP*** index of protection of enclosures of electrical equipment in accordance with standards IEC 529, BS 5490, DIN 400 50 and NF C 20-010

Up to 1000 V± and 1500 V= (standard UTE C 20 010)

1st figure:- protection against solid bodies

IP	tests	
0		No protection
1		Protected against solid bodies larger than 50 mm (eg.: accidental contact with the hand)
2		Protected against solid bodies larger than 12 mm (eg.: finger)
3		Protected against solid bodies larger than 2.5 mm (eg.: tools, wires)
4		Protected against solid bodies larger than 1 mm (eg.: fine tools and small wires)
5		Protected against dust (no harmful deposit)
6		Completely protected against dust

2nd figure:- protection against liquids

IP	tests	
0		No protection
1		Protected against vertically-falling drops of water (condensation)
2		Protected against drops of water falling at up to 15° from the vertical
3		Protected against drops of rain water at up to 60° from the vertical
4		Protected against projections of water from all directions
5		Protected against jets of water from all directions
6		Protected against jets of water of similar force to heavy seas
7		Protected against the effects of immersion
8		Protected against prolonged effects of immersion under pressure

The contents of all the above charts are for guidance only, if you have any doubt as to the interpretation of the information contained therein, please refer either to the standard itself or contact Legrand.

In accordance with our policy of continuous improvement, Legrand reserves the right to change specifications and designs without notice. All information given here is correct at the time of going to press.

ARTEOR™

VERSATILITY AND A
GLOBAL VISION FOR ANY
INSTALLATION LEVEL

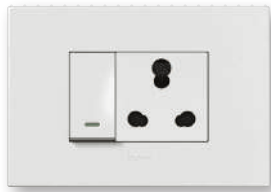

Arteor™ is the innovative answer to the increasingly complex requirements in the building business all over the world. Arteor™ excels by its unique aesthetics and a rich choice of innovative designs and ergonomical options.

The range extends from wiring devices, through innovative IoT based solutions, up to fully networked home automation systems based on BUS technology, which can also be integrated into third party solutions.

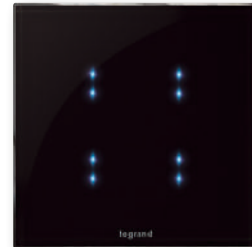

ARTEOR™

DESIGN FOR A GLOBAL LIFESTYLE



DESIGN OPTIONS FOR CONTROL FUNCTIONS

Arteor™ offers a wide choice of ergonomics and finishes to satisfy the most demanding customers. All stand-alone control functions are available in two shapes of rockers – round or square – and in three colours – white, magnesium and champagne.



Round rocker White

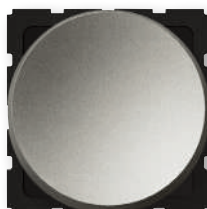

Round rocker Magnesium

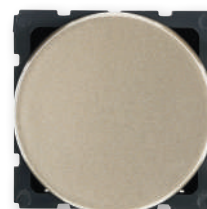

Round rocker Champagne

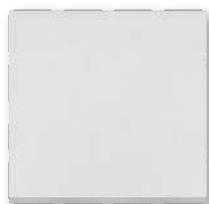

Square rocker White



Square rocker Magnesium



Square rocker Champagne



ARTEOR™

THE IDEAL SOLUTION,
ALWAYS AND
EVERYWHERE

Its versatility makes Arteor™ the ideal choice for every kind of project, anywhere in the world at any installation level. Arteor™ suits any requirement in terms of design and function for every kind of building, from residential to commercial.



Fan regulator



TV socket

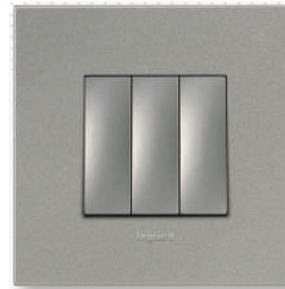

1-way switch - 3 gang



Bell push

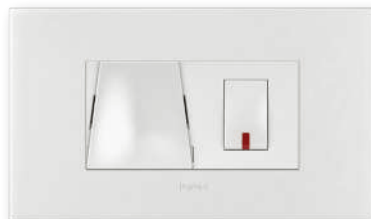

Power unit

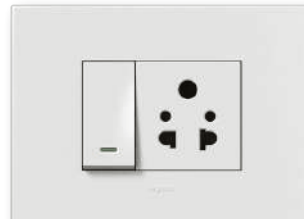

Switch & socket



Skirting light

HOME



MODERN HOME



6AX switch*



PIR Sensor



Triple RCA socket



Skirting light



USB charger



Time delay switch

*Switch compatible with LED light

ARTEOR™

OFFICE AND HOTEL SOLUTIONS

Offices and collective spaces require specific solutions and maximum flexibility: lighting adapted to each situation (meeting, conference, etc.), access security, comprehensive multimedia connections. The Arteor™ range meets all these expectations with perfect adaptability.



Automatic switch

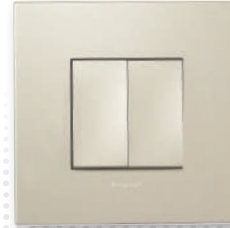

6 A 1 way switch



Preterminated HDMI sockets



USB socket



RJ45



Female HD15 + Jack



Universal touch dimmer*



Universal dimmer*

OFFICE



*For all loads including LED

ARTEOR™

A RICH CHOICE
OF FINISHES

NEUTRAL

White



Magnesium



MIRROR

Mirror Black



GRAPHIC

Casual



METAL

Stainless Steel



WOOD

Grey Oak



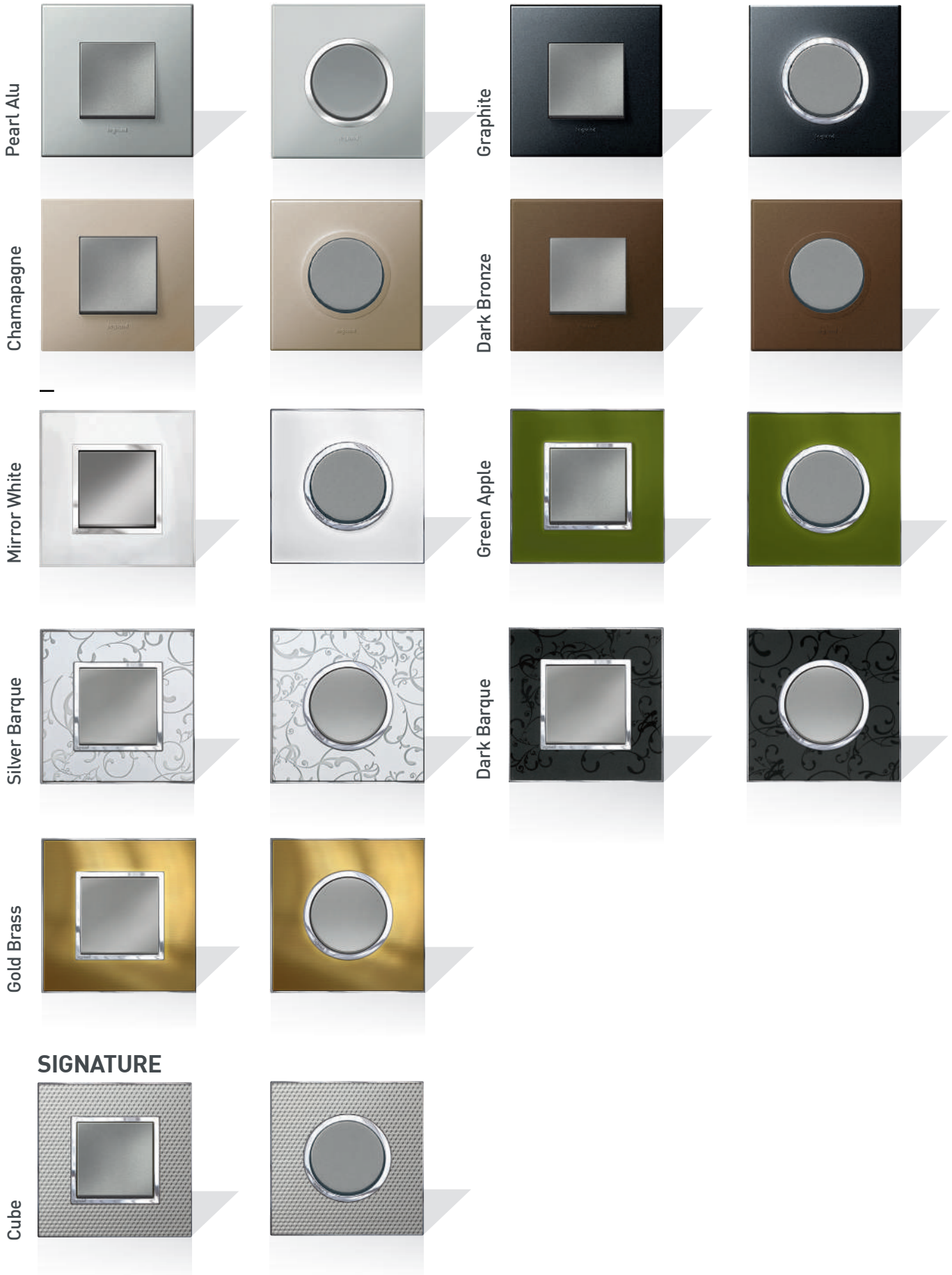

ARTEOR™

VERSATILITY AND
MODULARITY FOR
UNRIVALLED FLEXIBILITY

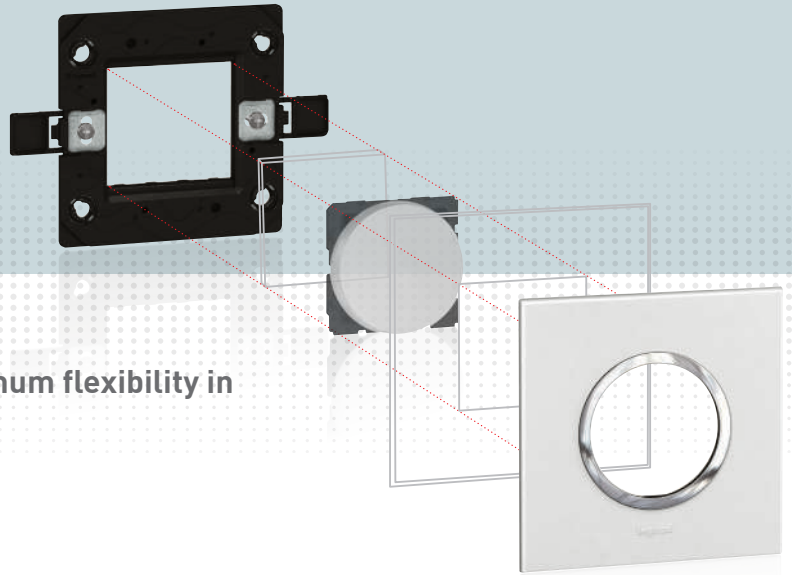

Arteor™ is a modular range offering maximum flexibility in terms of installation and configuration.

Protection at every step of the installation process

Support frames and plates are each supplied with special shrink wrap protection should be removed only once site work is fully completed.



Features that set ARTEOR™ apart



- ① Finger-proof terminals for IP 20 protection against accidental contact.
- ② Captive "never to loose screws"



- ① Tunnel terminals preventing screwdrivers from slipping.
- ② Laser marking on mechanisms. Arrow showing the correct orientation of the mechanism.
- ③ The latest IS 3854 : 1997.



Sockets with ISI mark, conforming to IS 1293. Fan regulator with ISI mark, conforming to IS 11037.



Fully shrouded internal mechanism under the rocker preventing visibility of sparks.



- ① Stripping templates on sockets for stripping off exact length of insulation.



Sockets are shuttered for child's safety against electric shocks.



Possibility of weather proofing mechanisms using Plexo IP 55 and IP 66 boxes.



For switches with LED lamps, life of LED is 50000 burning hours. Consumes power (0.76W) next to NIL.

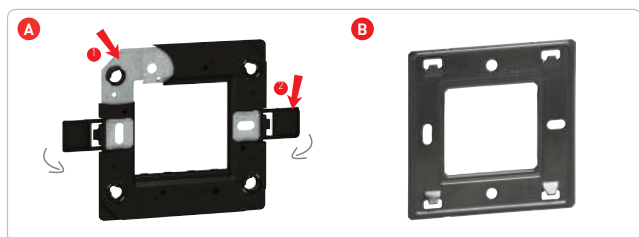

A. For all high end plates
Metal frame providing solid support to base.
Bi-material frame - electrical safety IP20.
Screw caps can be closed once the support frame is installed, ensuring total insulation.



2x2 way switch - 3 controls possible in 2 module plate. In round and square design possible.



Mechanisms compatible with DLP trunking systems, columns, floor boxes and VDI installations.

Arteor™ square - white mechanisms

Cat.Nos	Description	MRP* ₹ / Unit	Pack
---------	-------------	------------------	------

Switches – 6 A - 250 V AC

5734 00	Switch - 6 A - SP - 1 way 1 module	186	20/200
5734 01	Switch - 6 A - SP - 1 way with indicator - 1 module	292	20/200
5734 02	Switch - 6 A - SP - 2 way 1 module	258	20/200
5734 03	Switch - 6 A - SP - 2 way with indicator - 1 module	366	20/200

Switches – 10 A - 250 V AC

5734 50	Switch - 10 A - SP - 1 way 2 module	300	10/100
5734 51	Switch - 10 A - SP - 2 way 2 module	354	10/100
5720 37	Switch - 10 A - SP - 2 way with indicator & label holder - 2 module	1676	10/100
5720 38	Intermediate switch - 2 module	2006	10/100

Switches – 20 A - 250 V AC

5734 10	Switch - 20 A - SP - 1 way - 1 module	342	20/200
5734 52	Switch - 20 A - SP - 1 way - 2 module	408	10/100
5720 63	Switch - 20 A - SP - 1 way with indicator - 1 module	352	20/200
5734 11	Switch - 20 A - SP - 2 way with indicator - 1 module	492	20/200
5720 42	Switch - 20 A - SP - 2 way with indicator - 2 module	536	10/100
5720 43	Switch - 20 A - 3 gang - 1 way - 2 module	962	10/100
5720 44	Switch - 20 A - 3 gang - 2x2 way + 1x1 way - 2 module	1054	10/100
5734 54	Switch - 20 A - DP - 1 way with indicator - 2 module	758	10/100
5720 49	Switch - 20 A - DP - 1 way with indicator and water heater marking - 2 module	796	10/100

Accessory for switch with indicator

5738 06	LED for switch with indicator (blue)	60	5/50
5738 05	LED for switch with indicator (red)	52	5/50

Switches – 25 A - 230 V AC

5734 17	25 A switch with indicator	456	20/200
---------	----------------------------	-----	--------

Switches – 32 A / 40 A - 250 V AC

5734 12	Switch - 32 A - DP - 1 way with indicator - 2 module	1080	10/100
5735 30	Switch - 40 A - DP - 1 way with indicator - fits on 1/2 module box	1248	1/5/20

Push button – 6 A - 250 V AC

5734 13	Bell push - 6 A - SP - 1 way - 1 module	278	20/200
5734 59	Bell push - 6 A - SP - 1 way - 2 module	386	10/100
5734 04	Push button - 6 A - SP - 1 way - 1 module	292	20/200

* MRP - Maximum Retail Price Inclusive of all taxes including GST.
■ Price available on request

Arteor™ square - white mechanisms

Cat.Nos	Description	MRP* ₹ / Unit	Pack
---------	-------------	------------------	------

Push button – 6 A - 250 V AC

5734 05	Push button - 6 A-SP - 1 way with indicator - 1 module	370	20/200
5734 14	Bell push - 6 A-SP - 1 way with indicator - 1 module	366	20/200
5734 60	Bell push - 6 A-SP - 1 way with indicator - 2 module	520	10/100

Electric roller blinds control

5722 20	Double switch for electric shutter - 2 module	676	10/100
---------	--------------------------------------------------	-----	--------

Dimmers and fan regulators

5734 62	Light dimmer 60 to 400 watts - 2 module	1082	10/100
5734 16	Fan step regulator 100 watts - 1 module	894	1/5/50
5734 63	Fan step regulator 100 watts - 2 module	1104	1/10/100
5734 69	Fan step regulator 120 watts - 2 module (for 48 & 56" fans)	1178	1/10/100
5734 68	Fan step regulator - 2 module for energy saving fans	1174	1/10/100

Electronic dimmers

5734 65	Universal touch dimmer 3 M	6786	1/10
5722 39	Universal dimmer without neutral 400 W - 2 module	9938	1/10

Indian standard sockets

5734 70	Socket shuttered - 6 A - 2/3 pin - universal India 2 module	340	20/200
5734 71	Socket shuttered - 6/16 A - 3 pin - Indian - 2 module	450	10/100
5734 67	Socket shuttered - 6/16 A - 3 pin - Indian - 3 module	544	5/50
5734 72	Socket - 13 A - 3 pin - 2P+E BS - 2 module	708	10/100
5735 10	Socket with switch - 16 A - 3 pin - 2P+E - Indian - 3 module	1278	5/50
5720 59	Socket - 15/16 A - 2P - Euro/US - 1 module	364	10/100
5737 79	Socket - 6 A/13 A/15 A for 127 V, - double multistandard - 4 module	786	5/50
5734 73	Multistandard socket - 6/10/13 A - 2/3 pin for 250 V AC, 15 A for 127 V type - 2 pin - 2 module	428	10/100
5734 66	25 A socket - 2 module	550	10/100
5721 16	Euro/US - 15 A-127 V/16 A - 250 V, 2P + E with shutter 2 module	636	10/100

Bold Cat.Nos are products normally available with Legrand (India) Stockists.
Cat.Nos that are not bold - delivery within 4 - 8 weeks from the date of order.
Bold packing quantity is our mandatory packing. Orders to be placed by
Legrand (India) Stockist in multiples of the same.

Arteor™ square - white mechanisms

Cat.Nos	Description	MRP* ₹ / Unit	Pack
---------	-------------	------------------	------

Energy plugs

5738 86	6 A plug	124	1/10/100
5738 88	16 A plug	164	1/10/100
5738 07	25 A plug	188	1/10/100

USB chargers (IS13252 (Part 1) / IEC 60950-1)

5734 21	USB Charger 1 M 1000 mA	1508	1/5/50
5734 41*	USB Charger 1 M 1500 mA	1734	1/5/50
5734 22	Double USB Charger 2 M 2400 mA	2404	1/10/100

RJ 11 telephone sockets (Jack type)

5734 27	Telephone socket - double RJ11 - 1 module	398	20/200
5734 26	Telephone socket - RJ11 with shutter - 1 module	232	20/200

Information outlets - toolless

5734 29	Information socket - category 5e-UTP - 1 module	556	20/200
5734 75	Information socket - category 5e-UTP - 2 module	596	10/100
5734 28	Information socket - category 6-UTP - 1 module	856	20/200
5734 74	Information socket - category 6-UTP - 2 module	898	10/100

TV sockets

5734 25	TV Co-Axial socket - 1 module	242	20/200
---------	-------------------------------	-----	--------

Electronic chime

5734 43	Bell ding dong 230V - 2 module	366	1/10/100
---------	--------------------------------	-----	----------

Buzzer

5734 42	Buzzer - 230 V - 1 module	1302	20/200
---------	---------------------------	------	--------

Bell call indicator & register - 6A - 250V AC

5734 15	Bell call indicator with register - 6 A - 1 way - SP - 1 module	1626	20/200
5736 06	Set of labels for bell call indicator (1-20)	440	5/50

Lighting

5734 64	Skirting light with LED - 230 V - 3 module	876	1/5/25
5722 26	Skirting light with detector (LED) - 230 V - 2 module	14922	1/20
5722 34	Miniature emergency skirting light unit - 2 module	8824	1/20
5724 53	Over door light unit (Red) 2 module	490	10/100
5722 23	Over door light unit (White) 2 module	402	10/100
5724 52	Indicator unit with transparent LED with coloured labels - 1 module	652	10/100

* MRP - Maximum Retail Price Inclusive of all taxes including GST.
 * To be Introduced Shortly
 (1) Supplied with white plate
 ■ Price available on request

Arteor™ square - white mechanisms

Cat.Nos	Description	MRP* ₹ / Unit	Pack
---------	-------------	------------------	------

Power strip and power units

5737 80	Set of 3 multistandard socket + Switch pre-wired - 8 module	2292	1/10
5735 42 ⁽¹⁾	1 Power unit (AC & Geyser) 16 A - 4 module	1440	1/5
5721 54	Power unit (AC & Geyser) 32 A (with cable output)	1620	1/5

MCB

5723 61	MCB - 16 A-SPN - 2 module	3716	1
---------	---------------------------	------	---

RCBO

5734 85	RCBO - 16 A-SPN - 2 module	12678	1
---------	----------------------------	-------	---

Protectors

5734 40	Surge protector - 1 module	3872	20/200
5734 48	Surge protector - 2 module	4522	10/100

Hotel "DND and MMR" functions

5734 61	DND and MMR indicator with bell push 1+1 module	1746	5/50
5734 58	Internal control unit for DND & MMR 1+1 module	1254	10/100

Hotel keycard switch

5722 44	16 A key card switch 230 V 2 module	4772	1/20
5722 59	Key fob for above	1302	10/50

Shaver socket

5721 53	Shaver socket 230 V / 120 - 230 V with earth connector	4964	1
---------	--------------------------------------------------------	------	---

Infrared sensors

5740 47	PIR sensor with neutral 2 module	7746	1/20
5740 09	PIR sensor without neutral - 2 module	6870	1/20

Time switch

5720 55	Time delay switch 2 module	6270	1/20
---------	----------------------------	------	------

Audio-video sockets

5722 72	Double RCA socket (audio) 1 module	■	1/20
5722 73	Triple RCA socket (audio & video) 1 module	■	1/20
5722 74	Female 3.5 mm Jack - 1 module	■	1/20
5722 76	Female BNC 75 jack - 1 module	■	1/20
5722 83	Female XLR jack - 2 module	■	1/20
5723 70	Kit HD 15 + jack amplified transceiver	■	1
5720 97	Preterminated sockets Female HD15 - 1 module	■	1
5720 96	Preterminated sockets HDMI 1.4 - 1 module	■	1

Bold Cat.Nos are products normally available with Legrand (India) Stockists. Cat.Nos that are not bold - delivery within 4 - 8 weeks from the date of order. Bold packing quantity is our mandatory packing. Orders to be placed by Legrand (India) Stockist in multiples of the same.

Arteor™ square - white mechanisms

Cat.Nos	Description	MRP* ₹ / Unit	Pack
---------	-------------	------------------	------

Audio-video sockets

5722 84	Line dying down 100 V (25-30W) 2 module	■	1
5722 77	Male XLR jack 2 module	■	1/20
5722 78	Female 3.5 mm Jack - solder - 1 module	■	1/20
5722 75	USB socket - 1 module	■	1/20
5744 01	S-VIDEO socket - 1 module	■	1/40
5722 88	Female HD15 + Jack 3.5 mm - 2 module	■	1/20

Cable outlet

5734 80	45 A cable outlet 2 module	974	5/50
5734 33	Cord outlet with 8 mm diameter - 1 module	312	20/200
5734 79	Standard cord outlet - 2 module	444	10/100

Blanking plate

5734 49	1 module blank	48	20/200
5723 44	2 modules blank	68	10/100
5758 10	Blanking plate + frame - 2 module	396	10/100

Mounting accessories for panel

5760 15	Panel mounting support - 1 module	258	10/100
5760 16	Panel mounting support - 2 module	274	10/100
5760 50	DIN rail support 2 module	326	10/100

Square - magnesium mechanisms

Switches – 6 A - 250 V AC

5736 00	Switch - 6 A-SP - 1 way - 1 module	208	20/200
5736 01	Switch - 6 A-SP - 1 way with indicator - 1 module	334	20/200
5736 02	Switch - 6 A-SP - 2 way - 1 module	300	20/200
5736 03	Switch - 6 A-SP - 2 way with indicator - 1 module	426	20/200

Switches – 10 A - 250 V AC

5736 50	Switch - 10 A-SP - 1 way - 2 module	320	10/100
5736 51	Switch - 10 A-SP - 2 way - 2 module	378	10/100
5725 37	Switch - 10 A-SP - 2 way with indicator & label holder - 2 module	1888	10/100
5725 38	Intermediate switch - 2 module	2310	10/100

Switches – 20 A - 250 V AC

5736 10	Switch - 20 A-SP - 1 way 1 module	386	20/200
5736 52	Switch - 20 A-SP - 1 way 2 module	454	10/100

Arteor™ square - magnesium mechanisms

Cat.Nos	Description	MRP* ₹ / Unit	Pack
---------	-------------	------------------	------

Switches – 20 A - 250 V AC

5725 63	Switch - 20 A-SP - 1 way with indicator -1 module	408	20/200
5736 11	Switch - 20 A-SP - 2 way with indicator -1 module	558	20/200
5725 42	Switch - 20 A-SP - 2 way with indicator - 2 module	598	10/100
5725 43	Switch - 20 A-3 gang - 1 way - 2 module	1104	10/100
5725 44	Switch - 20 A-3 gang - 2x2 way + 1x1 way - 2 module	1152	10/100
5736 54	Switch 20 A-DP - 1 way with indicator - 2 module	894	10/100
5725 49	Switch - 20 A-DP - 1 way with indicator and water heater marking - 2 module	952	10/100

Switches – 25 A - 230 V AC

5736 17	25A switch with indicator	512	20/200
---------	---------------------------	-----	--------

Switches – 32 A / 40 A - 250 V AC

5736 12	Switch - 32 A-DP - 1 way with indicator - 2 module	1248	10/100
5737 30	Switch - 40 A-DP - 1 way with indicator - fits on 1/2 module box	1434	1/5/20

Push button – 6 A - 250 V AC

5736 13	Bell push - 6 A-SP- 1 way - 1 module	312	20/200
5736 59	Bell push - 6 A-SP - 1 way - 2 module	444	10/100
5736 04	Push button - 6 A-SP - 1 way -1 module	322	20/200
5736 05	Push button - 6 A-SP - 1 way with indicator - 1 module	428	20/200
5736 14	Bell push - 6 A-SP - 1 way with indicator - 1 module	426	20/200
5736 60	Bell push - 6 A-SP - 1 way with indicator - 2 module	594	10/100

Electric roller blinds control

5727 20	Double switch for electric shutter - 2 module	780	10/100
---------	--------------------------------------------------	-----	--------

Dimmers and fan regulators

5736 62	Light dimmer - 60 to 400 watts - 2 module	1250	10/100
5736 16	Fan step regulator - 100 watts - 1 module	1028	1/5/50
5736 63	Fan step regulator - 100 watts - 2 module	1270	1/10/100
5736 69	Fan step regulator - 120 watts - 2 module (for 48 & 56" fans)	1356	1/10/100
5736 68	Fan step regulator - 2 module for energy saving fan	1346	1/10/100











Electronic dimmer

5727 39	Universal dimmer without neutral 400 W - 2 module	10756	1/10
---------	------------------------------------------------------	-------	------

* MRP - Maximum Retail Price Inclusive of all taxes including GST.
■ Price available on request

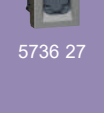

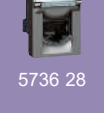

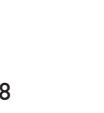





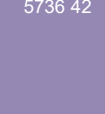

Bold Cat.Nos are products normally available with Legrand (India) Stockists.
Cat.Nos that are not bold - delivery within 4 - 8 weeks from the date of order.
Bold packing quantity is our mandatory packing. Orders to be placed by
Legrand (India) Stockist in multiples of the same.

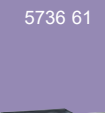
Arteor™ square - magnesium mechanisms

Cat.Nos	Description	MRP* ₹ / Unit	Pack
 5736 70	Socket shuttered - 6 A - 2/3 pin - universal India - 2 module	394	20/200
 5736 71	Socket shuttered - 6/16 A - 3 pin - Indian - 2 module	520	10/100
 5736 67	Socket shuttered - 6/16 A - 3 pin - Indian - 3 module	636	5/50
 5736 72	Socket - 13 A - 3 pin - 2P+E BS - 2 module	818	10/100
 5737 10	Socket with switch - 16 A - 3 pin - 2P+E - Indian 3 module	1470	5/50
 5720 86	Socket - 15/16 A - 2P - Euro/US - 1 module	420	10/100
 5739 79	Socket w - 6 A/13 A/15 A for 127 V, - double multistandard - 4 module	900	5/50
 5736 73	Multistandard socket - 6/10/13 A - 2/3 pin for 250 V AC 15 A for 127 V type - 2 pin 2 module	482	10/100
 5736 66	25 A socket - 2 module	634	10/100
 5726 16	Euro/US 15 A-127 VA/16 A 230 V 2P+E with shutter 2 M	754	10/100
USB chargers (IS13252 (Part 1) / IEC 60950-1)			
 5736 21	USB Charger 1M 1000mA	1740	1/5/50
 5734 44*	USB Charger 1M 1500 mA	2000	1/5/50
 5736 22	Double USB Charger 2M 2400mA	2766	1/10/100
RJ 11 telephone sockets (Jack type)			
5736 27	Telephone socket - double RJ11 - 1 module	456	20/200
5736 26	Telephone socket - RJ11 with shutter - 1 module	280	20/200
Information outlets - toolless			
5736 29	Information socket - category 5e - UTP - 1 module	640	20/200
5736 75	Information socket - category 5e - UTP - 2 module	686	10/100
5736 28	Information socket - category 6 - UTP - 1 module	976	20/200
5736 74	Information socket - category 6 - UTP - 2 module	1026	10/100
TV sockets			
5736 25	TV Co-Axial socket - 1 module	286	20/200
Electronic chime			
5736 43	Bell ding dong 230 V - 2 module	392	10/100

* MRP - Maximum Retail Price Inclusive of all taxes including GST.
 * To be Introduced Shortly
 (1) Supplied with white plate
 ■ Price available on request

Arteor™ square - magnesium mechanisms

Cat.Nos	Description	MRP* ₹ / Unit	Pack
Buzzer			
 5736 42	Buzzer- 230 V - 1 module	1426	20/200
Bell call indicator & register - 6A - 250V AC			
 5736 15	Bell call indicator with register - 6 A - 1 way - SP - 1 module	1878	20/200
Lighting			
 5735 64	Skirting light with LED - 230 V - 3 module	1008	1/5/25
 5727 26	Skirting light with detector (LED) - 230 V - 2 module	17156	1/20
Power strip and power units (without plate)			
 5739 80	Set of 3 multistandard socket + switch pre-wired - 8 module	2630	1/10
 5737 42 ⁽³⁾	Power unit (AC & Geyser) 16 A - 4 module	1670	1/5
 5726 54	Power unit (AC & Geyser) 32 A (with cable output) 4 module	1898	1/5
Hotel "DND and MMR " functions			
 5736 61	DND and MMR indicator with bell push 1+1 module	2006	5/50
 5736 58	Internal control unit for DND & MMR 1+1 module	1450	10/100
Hotel keycard switch			
 5727 44	16 A Key card switch 230 V with time delay - 2 module	5256	1/20
 5727 59	Key fob for above	1810	10/50
Shaver socket			
 5726 53	Shaver socket 230 V / 120-230 V with earth connector	5466	1
Infrared sensors			
 5740 97	PIR sensor with neutral - 2 module	8912	1/20
5740 59	PIR sensor without neutral - 2 module	8404	1/20
Time switch			
5740 84	Time delay switch - 2 module	6940	1/20
Audio-video sockets			
5727 72	Double RCA socket (audio) - 1 module	■	1/20
5727 73	Triple RCA socket (audio & video) - 1 module	■	1/20
5727 74	Female 3.5 mm Jack - 1 module	■	1/20
5727 76	Female BNC 75 jack - 1 module	■	1/20

Bold Cat.Nos are products normally available with Legrand (India) Stockists. Cat.Nos that are not bold - delivery within 4 - 8 weeks from the date of order. Bold packing quantity is our mandatory packing. Orders to be placed by Legrand (India) Stockist in multiples of the same.

Arteor™ square - magnesium mechanisms

Cat.Nos	Description	MRP* ₹ / Unit	Pack
---------	-------------	------------------	------

Audio-video sockets

5727 83	Female XLR jack - 2 module	■	1/20
5728 70	Kit HD 15 + Jack Amplified transceiver - 3*4 module	■	1
5725 97	Preterminated sockets Female HD15 - 1 module	■	1

Audio-video sockets

5725 96	Preterminated sockets HDMI 1.4 - 1 module	■	1
5727 84	Line dying down 100 V (25-30 W) 2 module	■	1
5727 77	Male XLR jack 2 module	■	1/20
5727 78	Female 3.5 mm Jack - solder - 1 module	■	1/20
5727 75	USB socket - 1 module	■	1/20
5744 51	S-VIDEO socket - 1 module	■	1/40
5727 88	Female HD15 + Jack 3.5 mm - 2 module	■	1/20

Blanking plate

5736 49	1 module blank	48	20/200
5728 44	2 modules blank	76	10/100

Dedicated switches

5738 00	Dedicated switch - 6 A - 1 way - SP - red - 1 module	248	20/200
5738 01	Dedicated switch - 10 A - 1 way - SP - red - 1 module	250	20/200
5738 02	Dedicated switch - 20 A - 1 way - DP - red - 1 module	864	5/40

Tamper proof and dedicated sockets

5738 08	Tamperproof red Indian socket 6 A (2/3 pin) - 2 module	688	20/200
5738 10	Dedicated socket with switch - 16 A - 3 pin - 2P+E - Indian - 3 module	1804	5/50
5738 09	Insert for tamper proof Indian socket - 6 A	92	1/20/200

Square - Champagne mechanisms

Switches – 6 A - 250 V AC

5748 00	Switch - 6 A-SP - 1 way - 1 module	208	20/200
5748 01	Switch - 6 A-SP - 1 way with indicator - 1 module	334	20/200
5748 02	Switch - 6 A-SP - 2 way - 1 module	300	20/200
5748 03	Switch - 6 A-SP - 2 way with indicator - 1 module	426	20/200

Arteor™ square - champagne mechanisms

Cat.Nos	Description	MRP* ₹ / Unit	Pack
---------	-------------	------------------	------

Switches – 10 A - 250 V AC

5748 04	Switch - 10 A-SP - 1 way - 2 module	320	10/100
5748 05	Switch - 10 A-SP - 2 way - 2 module	378	10/100
5748 06	Switch - 10 A-SP - 2 way with indicator & label holder - 2 module	1888	10/100
5748 07	Intermediate switch - 2 module	2310	10/100

Switches – 20 A - 250 V AC

5748 08	Switch - 20 A-SP - 1 way 1 module	386	20/200
5748 09	Switch - 20 A-SP - 1 way 2 module	454	10/100
5748 10	Switch - 20 A-SP - 1 way with indicator - 1 module	408	20/200
5748 11	Switch - 20 A-SP - 2 way with indicator - 1 module	558	20/200
5748 12	Switch - 20 A-SP - 2 way with indicator - 2 module	598	10/100
5748 13	Switch - 20 A-3 gang - 1 way - 2 module	1104	10/100
5748 14	Switch - 20 A-3 gang - 2x2 way + 1x1 way - 2 module	1152	10/100
5748 15	Switch 20 A-DP - 1 way with indicator - 2 module	894	10/100
5748 16	Switch - 20 A-DP - 1 way with indicator and water heater marking - 2 module	952	10/100

Switches – 25 A - 230 V AC

5748 17	25A switch with indicator	512	20/200
---------	---------------------------	-----	--------

Switches – 32 A / 40 A - 250 V AC

5748 18	Switch - 32 A-DP - 1 way with indicator - 2 module	1248	10/100
5748 19	Switch - 40 A-DP - 1 way with indicator - fits on 1/2 module box	1434	1/5/20

Push button – 6 A - 250 V AC

5748 23	Bell push - 6 A-SP - 1 way - 1 module	312	20/200
5748 24	Bell push - 6 A-SP - 1 way - 2 module	444	10/100
5748 21	Push button - 6 A-SP - 1 way - 1 module	322	20/200
5748 22	Push button - 6 A-SP - 1 way with indicator - 1 module	428	20/200
5748 25	Bell push - 6 A-SP - 1 way with indicator - 1 module	426	20/200
5748 26	Bell push - 6 A-SP - 1 way with indicator - 2 module	594	10/100

Electric roller blinds control

5748 20	Double switch for electric shutter - 2 module	780	10/100
---------	-----------------------------------------------	-----	--------



5736 49



5738 01



5738 08



5748 00



5748 01



5748 05



5748 07



5748 11



5748 15



5748 16



5748 17



5748 18



5748 23



5748 26



5748 20

* MRP - Maximum Retail Price Inclusive of all taxes including GST.
Red Cat.Nos - new products
■ Price available on request.

Bold Cat.Nos are products normally available with Legrand (India) Stockists.
Cat.Nos that are not bold - delivery within 4 - 8 weeks from the date of order.
Bold packing quantity is our mandatory packing. Orders to be placed by Legrand (India) Stockist in multiples of the same.

Arteor™ square - champagne mechanisms

Arteor™ square - champagne mechanisms

Cat.Nos	Description	MRP* ₹ / Unit	Pack
Dimmers and fan regulators			
5748 27	Light dimmer - 60 to 400 watts - 2 module	1288	10/100
5748 29	Fan step regulator - 100 watts - 1 module	1028	1/5/50
5748 30	Fan step regulator - 100 watts - 2 module	1270	1/10/100
5748 31	Fan step regulator - 120 watts - 2 module (for 48 & 56" fans)	1356	1/10/100
5748 32	Fan step regulator - 2 module for energy saving fan	1346	1/10/100
Indian standard sockets			
5748 33	Socket shuttered - 6 A - 2/3 pin - universal India - 2 module	392	20/200
5748 34	Socket shuttered - 6/16 A - 3 pin - Indian - 2 module	520	10/100
5748 35	Socket shuttered - 6/16 A - 3 pin - Indian - 3 module	636	5/50
5748 39	Socket w - 6 A/13 A/15 A for 127 V, - double multistandard - 4 module	900	5/50
5748 40	Multistandard socket - 6/10/13 A - 2/3 pin for 250 V AC 15 A for 127 V type - 2 pin 2 module	482	10/100
5748 41	25 A socket - 2 module	634	10/100
USB chargers (IS13252 (Part 1) / IEC 60950-1)			
5748 43	USB Charger 1M 1000mA	1740	1/5/50
5734 47*	USB Charger 1M 1500 mA	2000	1/5/50
5748 44	Double USB Charger 2M 2400mA	2766	1/10/100
RJ 11 telephone sockets (Jack type)			
5748 45	Telephone socket - double RJ11 - 1 module	456	20/200
5748 46	Telephone socket - RJ11 with shutter - 1 module	280	20/200
Information outlets - toolless			
5748 47	Information socket - category 5e - UTP - 1 module	640	20/200
5748 48	Information socket - category 5e - UTP - 2 module	686	10/100
5748 49	Information socket - category 6 - UTP - 1 module	976	20/200
5748 50	Information socket - category 6 - UTP - 2 module	1026	10/100
TV sockets			
5748 51	TV Co-Axial socket - 1 module	286	20/200

Cat.Nos	Description	MRP* ₹ / Unit	Pack
Electronic chime			
5748 52	Bell ding dong 230 V - 2 module	392	10/100
Buzzer			
5748 53	Buzzer- 230 V - 1 module	1426	20/200
Bell call indicator & register - 6A - 250V AC			
5748 54	Bell call indicator with register - 6 A - 1 way - SP - 1 module	1878	20/200
Lighting			
5748 55	Skirting light with LED - 230 V - 3 module	1008	1/5/25
Hotel "DND and MMR" functions			
5748 56	DND and MMR indicator with bell push 1+1 module	2006	5/50
5748 57	Internal control unit for DND & MMR 1+1 module	1450	10/100
Hotel keycard switch			
5748 58	16 A Key card switch 230 V with time delay - 2 module	5256	1/20
5727 59	Key fob for above	1810	10/50
Blanking plate			
5748 63	1 module blank	48	20/200
5748 64	2 modules blank	76	10/100
Round - white mechanisms			
Switches - 6 A - 250 V AC			
5733 00	Switch - 6 A-SP - 1 way left - 1 module	250	20/200
5733 01	Switch - 6 A-SP - 1 way right - 1 module	250	20/200
5733 12	Switch - 6 A-SP - 1 way - middle - 1 module	250	20/200
5733 05	Switch - 6 A-SP - 2 way - left - 1 module	310	20/200
5733 06	Switch - 6 A-SP - 2 way - right - 1 module	310	20/200
5733 02	Switch - 6 A-SP - 1 way with indicator - left - 1 module	352	20/200
5733 04	Switch - 6 A-SP - 1 way with indicator - right - 1 module	352	20/200
5733 03	Switch - 6 A-SP - 1 way with indicator - middle - 1 module	352	20/200
5733 07	Switch - 6 A-SP - 2 way with indicator - left - 1 module	442	20/200
5733 08	Switch - 6 A-SP - 2 way with indicator - right - 1 module	442	20/200

* MRP - Maximum Retail Price Inclusive of all taxes including GST.
 * To be Introduced Shortly
 Red Cat.Nos - new products
 (1) Supplied with white plate
 ■ Price available on request

Bold Cat.Nos are products normally available with Legrand (India) Stockists.
 Cat.Nos that are not bold - delivery within 4 - 8 weeks from the date of order.
 Bold packing quantity is our mandatory packing. Orders to be placed by Legrand (India) Stockist in multiples of the same.

Arteor™ round - white mechanisms

Cat.Nos	Description	MRP* ₹ / Unit	Pack
---------	-------------	------------------	------

Switches – 20 A - 250 V AC

5733 20	Switch - 20 A-SP - 1 way - left - 1 module	412	20/200
5733 21	Switch - 20 A-SP - 1 way - right - 1 module	412	20/200
5730 21	Switch - 20 A-SP - 1 way - middle - 1 module	416	20/200
5733 40	Switch - 20 A-SP - 1 way - 2 module	480	10/100
5720 64	Switch - 20 A-SP - 1 way with indicator-left - 1 module	424	20/200
5720 65	Switch - 20 A-SP - 1 way with indicator-right - 1 module	424	20/200
5730 24	Switch - 20 A-SP - 2 way - middle - 1 module	424	20/200
5733 22	Switch - 20 A-SP - 2 way with indicator-left - 1 module	590	20/200
5733 23	Switch - 20 A-SP - 2 way with indicator-right - 1 module	590	20/200
5730 71	Switch - 20 A-SP - 2 way with indicator - 2 module	522	10/100
5730 72	Switch - 20 A-3 gang - 1 way - 2 module	1150	10/100
5730 73	Switch - 20 A-3 gang - 2x2 way+1x1 way - 2 module	1268	10/100
5733 42	Switch 20 A-DP - 1 way with indicator - 2 module	894	10/100
5730 27	Switch - 20 A-SP - 2 way with indicator - middle - 1 module	590	20/200

Switches - 32 A

5733 26	Switch - 32 A-DP - 1 way with indicator - 2 module	1300	10/100
---------	----------------------------------------------------	------	--------

Push button – 6 A - 250 V AC

5733 31	Bell push - 6 A-SP - 1 way - right - 1 module	322	20/200
5733 30	Bell push - 6 A-SP - 1 way - left - 1 module	322	20/200
5733 46	Bell push - 6 A-SP - 1 way - 2 module	456	10/100
5733 09	Push button - 6 A-SP - 1 way - left - 1 module	342	20/200
5733 11	Push button - 6 A-SP - 1 way - right - 1 module	342	20/200
5733 47	Bell push - 6 A-SP - 1 way with indicator - 2 module	620	10/100
5733 10	Push button - 6 A-SP - 1 way - middle - 1 module	342	20/200

Electric roller blinds control

5732 20	Double pole switch 10 A - 2 module	812	10/100
---------	------------------------------------	-----	--------

Dimmers and fan regulators

5730 66	Light dimmer - 60 to 400 Watts - 2 module	1306	1/10/100
5730 03	Fan step regulator - 100 Watts - 2 module	1324	1/10/100
5730 69	Fan step regulator - 120 Watts - 2 module	1436	1/10/100
5730 04	Fan step regulator - 2 module for energy saving fans	1404	1/10/100

* MRP - Maximum Retail Price Inclusive of all taxes including GST.
■ Price available on request.

Arteor™ round - white mechanisms

Cat.Nos	Description	MRP* ₹ / Unit	Pack
---------	-------------	------------------	------

Electronic dimmer

5743 19	Universal dimmer without neutral 400 W - 2 module	11012	1/10
---------	---------------------------------------------------	-------	------

Multistandard sockets

5734 89	Multistandard socket 6/10/13 A - 2/3 pin for 250 V AC 15 A for 127 V type - 2 pin 2 module	488	10/100
---------	--------------------------------------------------------------------------------------------	-----	--------

USB chargers (IS13252 (Part 1) / IEC 60950-1)

5734 23	Double USB Charger 2M 2400mA	2660	1/10/100
---------	------------------------------	------	----------

Information outlets - toolless

5723 24	Information socket - category 6-UTP - 2 module	1144	10/100
---------	------------------------------------------------	------	--------

Hotel internal control units

5720 74	Internal control unit for DND & MMR - 1+1 module	1754	5/50
5720 67	DND & MMR indicator with bell push - 2 module	2204	5/40

Audio-video sockets

5732 72	Double RCA socket (audio) - 2 module	■	1/20
5732 73	Triple RCA socket (audio & video) - 2 module	■	1/20
5722 85	HDMI socket - 2 module	■	1/20
5745 01	S-VIDEO socket - 2 module	■	1/20
5722 89	Female HD15 + Jack 3.5 mm - 2 module	■	1/20

Blanking plate

5730 87	2 modules blank	78	10/100
---------	-----------------	----	--------

Round - magnesium mechanisms

Switches - 6 A - 250 V AC

5733 50	Switch - 6 A-SP - 1 way - left - 1 module	292	20/200
5733 51	Switch - 6 A-SP - 1 way - right - 1 module	292	20/200
5733 62	Switch - 6 A-SP - 1 way - middle - 1 module	292	20/200
5733 55	Switch - 6 A-SP - 2 way - left - 1 module	356	20/200
5733 56	Switch - 6 A-SP - 2 way - right - 1 module	356	20/200
5733 52	Switch - 6 A-SP - 1 way with indicator - left - 1 module	396	20/200

Switches - 6 A - 250 V AC

5733 54	Switch - 6 A-SP - 1 way with indicator - right - 1 module	396	20/200
5733 53	Switch - 6 A-SP - 1 way with indicator - middle - 1 module	396	20/200
5733 57	Switch - 6 A-SP - 2 way with indicator - left - 1 module	512	20/200
5733 58	Switch - 6 A-SP - 2 way with indicator - right - 1 module	512	20/200

Bold Cat.Nos are products normally available with Legrand (India) Stockists. Cat.Nos that are not bold - delivery within 4 - 8 weeks from the date of order. Bold packing quantity is our mandatory packing. Orders to be placed by Legrand (India) Stockist in multiples of the same.

Arteor™ round - magnesium mechanisms

Cat.Nos	Description	MRP* ₹ / Unit	Pack
---------	-------------	------------------	------

Switches - 20 A - 250 V AC

5733 70	Switch - 20 A-SP - 1 way - left - 1 module	458	20/200
5733 71	Switch - 20 A-SP - 1 way - right - 1 module	458	20/200
5731 21	Switch - 20 A-SP- 1 way - middle - 1 module	458	20/200
5733 90	Switch - 20 A-SP - 1 way - 2 module	546	10/100
5725 64	Switch - 20 A-SP - 1 way with indicator - left - 1 module	480	20/200
5725 65	Switch - 20 A-SP - 1 way with indicator - right - 1 module	480	20/200
5731 24	Switch - 20 A-SP - 2 way - middle - 1 module	486	20/200
5733 72	Switch - 20 A-SP - 2 way with indicator - left - 1 module	670	20/200
5733 73	Switch - 20 A-SP - 2 way with indicator - right - 1 module	670	20/200
5731 71	Switch - 20 A-SP - 2 way with indicator - 2 module	636	10/100
5731 72	Switch - 20 A-3 gang - 1 way - 2 module	1320	10/100
5731 73	Switch - 20 A-3 gang - 2x2 way + 1x1 way - 2 module	1394	10/100
5733 92	Switch 20 A-DP - 1 way with indicator - 2 module	1030	10/100
5731 27	Switch - 20 A-SP - 2 way with indicator - middle - 1 module	670	20/200

Switches - 32A

5733 76	Switch - 32 A-DP - 1 way with indicator - 2 module	1488	10/100
---------	----------------------------------------------------	------	--------

Push button - 6 A - 250 V AC

5733 81	Bell push - 6 A-SP - 1 way - right - 1 module	378	20/200
5733 80	Bell push - 6 A-SP - 1 way - left - 1 module	378	20/200
5733 96	Bell push - 6 A-SP - 1 way - 2 module	536	10/100
5733 59	Push button - 6 A-SP - 1 way - left - 1 module	396	20/200
5733 61	Push button - 6 A-SP - 1 way - right - 1 module	396	20/200
5733 97	Bell push - 6 A-SP - 1 way with indicator - 2 module	704	10/100
5733 60	Push button - 6 A-SP - 1 way - middle - 1 module	396	20/200

Electronic roller blinds control

5737 20	Double pole switch 10 A - 2 module	942	10/100
---------	------------------------------------	-----	--------

Dimmers and fan regulators

5733 66	Light dimmer - 60 to 400 watts - 2 module	1514	1/10/100
5731 03	Fan step regulator - 100 watts - 2 module	1520	1/10/100
5731 69	Fan step regulator - 120 watts - 2 module	1640	1/10/100
5731 04	Fan step regulator - 2 module for energy saving fans	1620	1/10/100

* MRP - Maximum Retail Price Inclusive of all taxes including GST.
Red Cat.Nos - new products
■ Price available on request.

Arteor™ round - magnesium mechanisms

Cat.Nos	Description	MRP* ₹ / Unit	Pack
---------	-------------	------------------	------

Electronic dimmer

5743 39	Universal dimmer without neutral 400 W - 2 module	13506	1/10
---------	---------------------------------------------------	-------	------

Multistandard sockets

5736 89	Multistandard socket 6/10/13 A - 2/3 pin for 250 V AC 15 A for 127 V type - 2 pin 2 module	564	10/100
---------	--------------------------------------------------------------------------------------------	-----	--------

USB chargers (IS13252 (Part 1) / IEC 60950-1)

5736 23	Double USB Charger 2M 2400mA	3046	1/10/100
---------	------------------------------	------	----------

Information outlets - toolless

5728 24	Information socket - category 6 - UTP - 2 module	1308	10/100
---------	--------------------------------------------------	------	--------

Hotel internal control units

5725 74	Internal control unit for DND & MMR - 1+1 module	2014	5/50
5725 67	DND & MMR Indicator with bell push - 2 module	2406	5/40

Audio-video sockets

5737 72	Double RCA socket (audio) - 2 module	■	1/20
5737 73	Triple RCA socket (audio & video) - 2 module	■	1/20
5727 85	HDMI socket - 2 module	■	1/20
5745 51	S-VIDEO socket - 2 module	■	1/20
5727 89	Female HD15 + jack 3.5 mm - 2 module	■	1/20

Blanking plate

5731 87	2 modules blank	90	10/100
---------	-----------------	----	--------

Round - champagne mechanisms

Switches - 6 A - 250 V AC

5749 00	Switch - 6 A-SP - 1 way - left - 1 module	292	20/200
5749 01	Switch - 6 A-SP - 1 way - right - 1 module	292	20/200
5749 02	Switch - 6 A-SP - 1 way - middle - 1 module	292	20/200
5749 03	Switch - 6 A-SP - 2 way - left - 1 module	356	20/200
5749 04	Switch - 6 A-SP - 2 way - right - 1 module	356	20/200
5749 05	Switch - 6 A-SP - 1 way with indicator - left - 1 module	396	20/200
5749 06	Switch - 6 A-SP - 1 way with indicator - right - 1 module	396	20/200
5749 07	Switch - 6 A-SP - 1 way with indicator - middle - 1 module	396	20/200
5749 08	Switch - 6 A-SP - 2 way with indicator - left - 1 module	512	20/200
5749 09	Switch - 6 A-SP - 2 way with indicator - right - 1 module	512	20/200

Bold Cat.Nos are products normally available with Legrand (India) Stockists. Cat.Nos that are not bold - delivery within 4 - 8 weeks from the date of order. Bold packing quantity is our mandatory packing. Orders to be placed by Legrand (India) Stockist in multiples of the same.

Arteor™ round - champagne mechanisms

Cat.Nos	Description	MRP* ₹ / Unit	Pack
---------	-------------	------------------	------

Switches - 20 A - 250 V AC

5749 10	Switch - 20 A-SP - 1 way - left - 1 module	458	20/200
5749 11	Switch - 20 A-SP - 1 way - right - 1 module	458	20/200
5749 12	Switch - 20 A-SP - 1 way - middle - 1 module	458	20/200
5749 13	Switch - 20 A-SP - 1 way - 2 module	546	10/100
5749 14	Switch - 20 A-SP - 1 way with indicator - left - 1 module	480	20/200
5749 15	Switch - 20 A-SP - 1 way with indicator - right - 1 module	480	20/200
5749 16	Switch - 20 A-SP - 2 way - middle - 1 module	486	20/200
5749 17	Switch - 20 A-SP - 2 way with indicator - left - 1 module	670	20/200
5749 18	Switch - 20 A-SP - 2 way with indicator - right - 1 module	670	20/200
5749 19	Switch - 20 A-SP - 2 way with indicator - 2 module	636	10/100
5749 20	Switch - 20 A-3 gang - 1 way - 2 module	1320	10/100
5749 21	Switch - 20 A-3 gang - 2x2 way + 1x1 way - 2 module	1394	10/100
5749 22	Switch 20 A-DP - 1 way with indicator - 2 module	1030	10/100

Push button - 6 A - 250 V AC

5749 23	Bell push - 6 A-SP - 1 way - right - 1 module	378	20/200
5749 24	Bell push - 6 A-SP - 1 way - left - 1 module	378	20/200
5749 25	Bell push - 6 A-SP - 1 way - 2 module	536	10/100
5749 26	Bell push - 6 A-SP - 1 way with indicator - 2 module	704	10/100

Dimmers and fan regulators

5749 27	Light dimmer - 60 to 400 watts - 2 module	1560	1/10/100
5749 29	Fan step regulator - 100 watts - 2 module	1520	1/10/100
5749 30	Fan step regulator - 120 watts - 2 module	1640	1/10/100
5749 31	Fan step regulator - 2 module for energy saving fans	1620	1/10/100

Multistandard sockets

5749 40	Multistandard socket 6/10/13 A - 2/3 pin for 250 V AC 15 A for 127 V type - 2 pin 2 module	564	10/100
---------	--------------------------------------------------------------------------------------------	-----	--------

USB chargers (IS13252 (Part 1) / IEC 60950-1)

5749 44	Double USB Charger 2M 2400mA	3046	1/10/100
---------	------------------------------	------	----------

Blanking plate

5749 64	2 modules blank	90	10/100
---------	-----------------	----	--------

* MRP - Maximum Retail Price Inclusive of all taxes including GST.
Red Cat.Nos - new products

Arteor™ square cover plates

Cat.Nos	Description	MRP* ₹ / Unit	Pack
---------	-------------	------------------	------

Square cover plates with Metal Frame White cover plates with Metal frame

5757 00	White plate - 1 module	190	10/100
5757 10	White plate - 2 module	202	10/100
5757 20	White plate - 3 module	222	10/100
5757 30	White plate - 4 module	236	5/50
5757 40	White plate - 6 module	428	5/30
5757 50	White plate - 8 module	478	5/30
5757 60	White plate - 2x4 module	600	2/20
5757 70	White plate - 2x6 module	736	2/16
5757 80	White plate - 2x8 module	880	2/16
5757 90	White plate - 3x6 module	974	2/12
5758 00	White plate - 3x8 module	1162	2/12
5750 70	White plate for shaver socket 3 module	332	5/50

Pearl Aluminium cover plates with Metal frame

5759 73	Pearl Aluminium plate - 1 module	278	10/100
5759 74	Pearl Aluminium plate - 2 module	290	10/100
5759 75	Pearl Aluminium plate - 3 module	314	10/100
5759 76	Pearl Aluminium plate - 4 module	354	5/50
5759 77	Pearl Aluminium plate - 6 module	606	5/30
5759 78	Pearl Aluminium plate - 8 module	670	5/30
5759 79	Pearl Aluminium plate - 2x4 module	848	2/20
5759 80	Pearl Aluminium plate - 2x6 module	1104	2/16
5759 81	Pearl Aluminium plate - 2x8 module	1250	2/16
5759 82	Pearl Aluminium plate - 3x6 module	1458	2/12
5759 83	Pearl Aluminium plate - 3x8 module	1664	2/12

Graphite cover plates with Metal frame

5759 61	Graphite plate - 1 module	278	10/100
5759 62	Graphite plate - 2 module	290	10/100
5759 63	Graphite plate - 3 module	314	10/100
5759 64	Graphite plate - 4 module	354	5/50
5759 66	Graphite plate - 6 module	606	5/30
5759 67	Graphite plate - 8 module	670	5/30
5759 68	Graphite plate - 2x4 module	848	2/20
5759 69	Graphite plate - 2x6 module	1104	2/16
5759 70	Graphite plate - 2x8 module	1250	2/16
5759 71	Graphite plate - 3x6 module	1458	2/12
5759 72	Graphite plate - 3x8 module	1664	2/12

Magnesium cover plates with Metal frame

5755 89	Magnesium plate - 1 module	278	10/100
5755 90	Magnesium plate - 2 module	290	10/100
5755 91	Magnesium plate - 3 module	314	10/100
5755 93	Magnesium plate - 4 module	352	5/50
5755 94	Magnesium plate - 6 module	604	5/30
5755 95	Magnesium plate - 8 module	670	5/30
5755 96	Magnesium plate - 2x4 module	848	2/20
5755 97	Magnesium plate - 2x6 module	1104	2/16
5755 98	Magnesium plate - 2x8 module	1250	2/16
5755 99	Magnesium plate - 3x6 module	1458	2/12

Champagne cover plates with Metal frame

5759 84	Champagne plate - 1 module	278	10/100
5759 85	Champagne plate - 2 module	290	10/100
5759 86	Champagne plate - 3 module	314	10/100
5759 87	Champagne plate - 4 module	352	5/50

Bold Cat.Nos are products normally available with Legrand (India) Stockists.
Cat.Nos that are not bold - delivery within 4 - 8 weeks from the date of order.
Bold packing quantity is our mandatory packing. Orders to be placed by Legrand (India) Stockist in multiples of the same.

Arteor™ square cover plates

Cat.Nos	Description	MRP* ₹ / Unit	Pack
---------	-------------	------------------	------

NEW!

Champagne cover plates with Metal frame

5759 88	Champagne plate - 6 module	604	5/30
5759 89	Champagne plate - 8 module	670	5/30
5759 90	Champagne plate - 2x4 module	848	2/20
5759 91	Champagne plate - 2x6 module	1104	2/16
5759 92	Champagne plate - 2x8 module	1250	2/16
5759 93	Champagne plate - 3x6 module	1458	2/12

NEW!

Dark Bronze cover plates with Metal frame

5756 79	Dark Bronze plate - 1 module	278	10/100
5756 80	Dark Bronze plate - 2 module	290	10/100
5756 81	Dark Bronze plate - 3 module	314	10/100
5756 83	Dark Bronze plate - 4 module	352	5/50
5756 84	Dark Bronze plate - 6 module	604	5/30
5756 85	Dark Bronze plate - 8 module	670	5/30
5756 86	Dark Bronze plate - 2x4 module	848	2/20
5756 87	Dark Bronze plate - 2x6 module	1104	2/16
575688	Dark Bronze plate - 2x8 module	1250	2/16
5756 89	Dark Bronze plate - 3x6 module	1458	2/12

Pearl aluminium cover plates with Overmoulded frame

5757 01	Pearl aluminium plate - 1 module	310	10/100
5757 11	Pearl aluminium plate - 2 module	326	10/100
5757 21	Pearl aluminium plate - 3 module	346	10/100
5757 31	Pearl aluminium plate - 4 module	390	5/50
5757 41	Pearl aluminium plate - 6 module	672	5/30
5757 51	Pearl aluminium plate - 8 module	744	5/30
5757 61	Pearl aluminium plate - 2x4 module	942	2/20
5757 71	Pearl aluminium plate - 2x6 module	1224	2/16
5757 81	Pearl aluminium plate - 2x8 module	1388	2/16
5757 91	Pearl aluminium plate - 3x6 module	1624	2/12
5758 01	Pearl aluminium plate - 3x8 module	1848	2/12
5750 71	Pearl aluminium plate for shaver socket 3 module	528	5/50

Graphite cover plates with Overmoulded frame

5757 02	Graphite plate - 1 module	310	10/100
5757 12	Graphite plate - 2 module	326	10/100
5757 22	Graphite plate - 3 module	346	10/100
5757 32	Graphite plate - 4 module	390	5/50
5757 42	Graphite plate - 6 module	672	5/30
5757 52	Graphite plate - 8 module	744	5/30
5757 62	Graphite plate - 2x4 module	942	2/20
5757 72	Graphite plate - 2x6 module	1224	2/16
5757 82	Graphite plate - 2x8 module	1388	2/16
5757 92	Graphite plate - 3x6 module	1624	2/12
5758 02	Graphite plate - 3x8 module	1848	2/12
5750 72	Graphite plate for shaver socket 3 module	528	5/50

* MRP - Maximum Retail Price Inclusive of all taxes including GST.
Red Cat.Nos - new products

Arteor™ square cover plates

Cat.Nos	Description	MRP* ₹ / Unit	Pack
---------	-------------	------------------	------

Magnesium cover plates with Overmoulded frame

5758 11	Magnesium plate - 1 module	310	10/100
5758 12	Magnesium plate - 2 module	326	10/100
5758 13	Magnesium plate - 3 module	346	10/100
5758 14	Magnesium plate - 4 module	388	5/50
5758 15	Magnesium plate - 6 module	668	5/30
5758 16	Magnesium plate - 8 module	744	5/30
5758 17	Magnesium plate - 2x4 module	942	2/20
5758 18	Magnesium plate - 2x6 module	1224	2/16
5758 19	Magnesium plate - 2x8 module	1388	2/16
5758 20	Magnesium plate - 3x6 module	1624	2/12
5758 21	Magnesium plate for shaver socket 3 module	528	5/50

Champagne cover plates with Overmoulded frame

5758 22	Champagne plate - 1 module	310	10/100
5758 23	Champagne plate - 2 module	326	10/100
5758 24	Champagne plate - 3 module	346	10/100
5758 25	Champagne plate - 4 module	388	5/50
5758 26	Champagne plate - 6 module	668	5/30
5758 27	Champagne plate - 8 module	744	5/30
5758 28	Champagne plate - 2x4 module	942	2/20
5758 29	Champagne plate - 2x6 module	1224	2/16
5758 30	Champagne plate - 2x8 module	1388	2/16
5758 31	Champagne plate - 3x6 module	1624	2/12
5758 32	Champagne plate for shaver socket 3 module	528	5/50

Dark Bronze cover plates with Overmoulded frame

5758 33	Dark Bronze plate - 1 module	310	10/100
5758 34	Dark Bronze plate - 2 module	326	10/100
5758 35	Dark Bronze plate - 3 module	346	10/100
5758 36	Dark Bronze plate - 4 module	388	5/50
5758 37	Dark Bronze plate - 6 module	668	5/30
5758 38	Dark Bronze plate - 8 module	744	5/30
5758 39	Dark Bronze plate - 2x4 module	942	2/20
5758 40	Dark Bronze plate - 2x6 module	1224	2/16
5758 41	Dark Bronze plate - 2x8 module	1388	2/16
5758 42	Dark Bronze plate - 3x6 module	1624	2/12
5758 43	Dark Bronze plate for shaver socket 3 module	528	5/50

Mirror finish cover plates with Overmoulded frame

5757 03	Mirror black plate - 1 module	1532	1/5/30
5757 13	Mirror black plate - 2 module	1638	1/5/30
5757 23	Mirror black plate - 3 module	1758	1/20
5757 33	Mirror black plate - 4 module	1866	1/20
5757 43	Mirror black plate - 6 module	3398	1/5
5757 53	Mirror black plate - 8 module	3740	1/5
5757 63	Mirror black plate - 2x4 module	4738	1/10
5757 73	Mirror black plate - 2x6 module	5830	1/8
5750 73	Mirror black plate for shaver socket 3 module	2406	1/5/50
5757 04	Mirror white plate - 1 module	1532	1/5/30
5757 14	Mirror white plate - 2 module	1638	1/5/30
5757 24	Mirror white plate - 3 module	1758	1/20
5757 34	Mirror white plate - 4 module	1866	1/20
5757 44	Mirror white plate - 6 module	3398	1/5
5757 54	Mirror white plate - 8 module	3740	1/5

Bold Cat.Nos are products normally available with Legrand (India) Stockists. Cat.Nos that are not bold - delivery within 4 - 8 weeks from the date of order. Bold packing quantity is our mandatory packing. Orders to be placed by Legrand (India) Stockist in multiples of the same.

Arteor™ square cover plates

Cat.Nos	Description	MRP* ₹ / Unit	Pack
---------	-------------	------------------	------

Mirror finish cover plates with Overmoulded frame

5757 64	Mirror white plate - 2x4 module	4830	1/10
5757 74	Mirror white plate - 2x6 module	5830	1/8
5750 74	Mirror white plate for shaver socket 3 module	2406	1/5/50
5758 44	Green Apple plate - 1 module	1532	1/5/30
5758 45	Green Apple plate - 2 module	1638	1/5/30
5758 46	Green Apple plate - 3 module	1758	1/20
5758 47	Green Apple plate - 4 module	1866	1/20
5758 48	Green Apple plate - 6 module	3398	1/5
5758 49	Green Apple plate - 8 module	3740	1/5
5758 50	Green Apple plate - 2x4 module	4828	1/10
5758 51	Green Apple plate - 2x6 module	5830	1/8
5758 52	Green Apple plate for shaver socket 3 module	2556	1/5/50

Graphic cover plates with Overmoulded frame

5762 91	Graphic casual plate - 1 module	1860	1/5/30
5763 11	Graphic casual plate - 2 module	2004	1/5/30
5763 31	Graphic casual plate - 3 module	2154	1/5/20
5763 51	Graphic casual plate - 4 module	2298	1/20
5763 81	Graphic casual plate - 6 module	4156	1/5
5764 01	Graphic casual plate - 8 module	4584	1/5
5758 89	Graphic casual plate - 2x4 module	5774	1/10
5758 90	Graphic casual plate - 2x6 module	7150	1/8
5761 61	Graphic casual for shaver socket 3 module	2940	1/5/50

Silver Baroque plates with Overmoulded frame

5758 53	Silver Baroque plate -1 module	1860	1/5/30
5758 54	Silver Baroque plate - 2 module	2004	1/5/30
5758 55	Silver Baroque plate - 3 module	2154	1/20
5758 56	Silver Baroque plate - 4 module	2298	1/20
5758 57	Silver Baroque plate - 6 module	4156	1/5
5758 58	Silver Baroque plate - 8 module	4584	1/5
5758 59	Silver Baroque plate - 2x4 module	5774	1/10
5758 60	Silver Baroque plate - 2x6 module	7150	1/8
5758 61	Silver Baroque plate for shaver socket 3 module	2940	1/5/50

Dark Baroque plates with Overmoulded frame

5758 62	Dark Baroque plate - 1 module	1860	1/5/30
5758 63	Dark Baroque plate - 2 module	2004	1/5/30
5758 64	Dark Baroque plate - 3 module	2154	1/20
5758 65	Dark Baroque plate - 4 module	2298	1/20
5758 66	Dark Baroque plate - 6 module	4156	1/5
5758 67	Dark Baroque plate - 8 module	4584	1/5
5758 68	Dark Baroque plate - 2x4 module	5774	1/10
5758 69	Dark Baroque plate - 2x6 module	7150	1/8
5758 70	Dark Baroque plate for shaver socket 3 module	2940	1/5/50

Metal finish cover plates with Overmoulded frame

5762 90	Gold brass plate - 1 module	2498	1/5/30
5763 10	Gold brass plate - 2 module	2674	1/5/30

* MRP - Maximum Retail Price Inclusive of all taxes including GST.
Red Cat.Nos - new products

Arteor™ square cover plates

Cat.Nos	Description	MRP* ₹ / Unit	Pack
---------	-------------	------------------	------

Metal finish cover plates with Overmoulded frame

5763 30	Gold brass plate -3 module	2876	1/20
5763 50	Gold brass plate - 4 module	3052	1/20
5763 80	Gold brass plate - 6 module	5554	1/5
5764 00	Gold brass plate - 8 module	6106	1/5
5761 60	Gold brass plate - for shaver socket 3 module	3276	1/5/50
5757 06	Stainless steel plate - 1 module	2498	1/5/30
5757 16	Stainless steel plate - 2 module	2674	1/5/30
5757 26	Stainless steel plate - 3 module	2876	1/20
5757 36	Stainless steel plate - 4 module	3052	1/20
5757 46	Stainless steel plate - 6 module	5554	1/5
5757 66	Stainless steel plate - 2x4 module	7720	1/10
5757 56	Stainless steel plate - 8 module	6106	1/5
5757 76	Stainless steel plate - 2x6 module	9514	1/8
5750 76	Stainless steel plate - for shaver socket 3 module	3276	1/5/50

Wood cover plates with Overmoulded frame

5758 80	Grey Oak plate - 1 module	1464	1/5/30
5758 81	Grey Oak plate - 2 module	1550	1/5/30
5758 82	Grey Oak plate - 3 module	1918	1/20
5758 83	Grey Oak plate - 4 module	2124	1/20
5758 84	Grey Oak plate - 6 module	3156	1/5
5758 85	Grey Oak plate - 8 module	3800	1/5
5758 86	Grey Oak plate - 2x4 module	4506	1/10
5758 87	Grey Oak plate - 2x6 module	6040	1/8
5758 88	Grey Oak plate for shaver socket 3 module	1872	1/5/50

Signature cover plates with Overmoulded frame

5758 71	Cube plate - 1 module	4790	1/5/30
5758 72	Cube plate - 2 module	4876	1/5/30
5758 73	Cube plate - 3 module	5574	1/20
5758 74	Cube plate - 4 module	5760	1/20
5758 75	Cube plate - 6 module	7504	1/5
5758 76	Cube plate - 8 module	7880	1/5
5758 77	Cube plate - 2x4 module	11772	1/10
5758 78	Cube plate - 2x6 module	13040	1/8
5758 79	Cube plate for shaver socket 3 module	5348	1/5/50

Round cover plates with Metal Frame

White cover plates with Metal frame

5759 00	White plate - 2 module	292	10/100
5759 10	White plate - 3 module	304	10/100
5759 20	White plate - 4 module	322	5/50
5759 30	White plate - 6 module	586	5/30
5765 80	White plate - 8 module	648	5/30
5759 40	White plate - 2x4 module	686	2/20
5759 50	White plate - 2x6 module	1002	2/16

Pearl Aluminium cover plates with Metal frame

5757 93	Pearl Aluminium plate - 2 module	380	10/100
5757 94	Pearl Aluminium plate - 3 module	406	10/100
5757 95	Pearl Aluminium plate - 4 module	462	5/50
5757 96	Pearl Aluminium plate - 6 module	790	5/30
5757 97	Pearl Aluminium plate - 8 module	872	5/30
5757 98	Pearl Aluminium plate - 2x4 module	1102	2/20
5757 99	Pearl Aluminium plate - 2x6 module	1436	2/16

Bold Cat.Nos are products normally available with Legrand (India) Stockists. Cat.Nos that are not bold - delivery within 4 - 8 weeks from the date of order. Bold packing quantity is our mandatory packing. Orders to be placed by Legrand (India) Stockist in multiples of the same.

Arteor™ round cover plates

Cat.Nos	Description	MRP* ₹ / Unit	Pack
---------	-------------	------------------	------

NEW! Graphite cover plates with Metal frame

5758 03	Graphite plate - 2 module	380	10/100
5758 04	Graphite plate - 3 module	406	10/100
5758 05	Graphite plate - 4 module	462	5/50
5758 06	Graphite plate - 6 module	790	5/30
5758 07	Graphite plate - 8 module	872	5/30
5758 08	Graphite plate - 2x4 module	1102	2/20
5758 09	Graphite plate - 2x6 module	1436	2/16

NEW! Magnesium cover plates with Metal frame

5756 23	Magnesium plate - 2 module	380	10/100
5756 24	Magnesium plate - 3 module	406	10/100
5756 25	Magnesium plate - 4 module	460	5/50
5756 26	Magnesium plate - 6 module	788	5/30
5756 27	Magnesium plate - 8 module	872	5/30
5756 28	Magnesium plate - 2x4 module	1102	2/20
5756 29	Magnesium plate - 2x6 module	1436	2/16

NEW! Champagne cover plates with Metal frame

5758 91	Champagne plate - 2 module	380	10/100
5758 92	Champagne plate - 3 module	406	10/100
5758 93	Champagne plate - 4 module	460	5/50
5758 94	Champagne plate - 6 module	788	5/30
5758 95	Champagne plate - 8 module	872	5/30
5758 96	Champagne plate - 2x4 module	1102	2/20
5758 97	Champagne plate - 2x6 module	1436	2/16

NEW! Dark Bronze cover plates with Metal frame

5756 93	Dark Bronze plate - 2 module	380	10/100
5756 94	Dark Bronze plate - 3 module	406	10/100
5756 95	Dark Bronze plate - 4 module	460	5/50
5756 96	Dark Bronze plate - 6 module	788	5/30
5756 97	Dark Bronze plate - 8 module	872	5/30
5756 98	Dark Bronze plate - 2x4 module	1102	2/20
5756 99	Dark Bronze plate - 2x6 module	1436	2/16

Pearl aluminium cover plates with Overmoulded frame

5759 01	Pearl aluminium plate - 2 module	430	10/100
5759 11	Pearl aluminium plate - 3 module	452	10/100
5759 21	Pearl aluminium plate - 4 module	482	5/50
5759 31	Pearl aluminium plate - 6 module	872	5/30
5765 81	Pearl aluminium plate - 8 module	960	5/30
5759 41	Pearl aluminium plate - 2x4 module	1010	2/20
5759 51	Pearl aluminium plate - 2x6 module	1492	2/16

Graphite cover plates with Overmoulded frame

5759 02	Graphite plate - 2 module	430	10/100
5759 12	Graphite plate - 3 module	452	10/100
5759 22	Graphite plate - 4 module	482	5/50
5759 32	Graphite plate - 6 module	872	5/30
5765 82	Graphite plate - 8 module	960	5/30
5759 42	Graphite plate - 2x4 module	1010	2/20
5759 52	Graphite plate - 2x6 module	1492	2/16

Magnesium cover plates with Overmoulded frame

5768 41	Magnesium plate - 2 module	430	10/100
5768 42	Magnesium plate - 3 module	454	10/100
5768 43	Magnesium plate - 4 module	484	5/50

* MRP - Maximum Retail Price Inclusive of all taxes including GST.
Red Cat.Nos - new products

Arteor™ square cover plates

Cat.Nos	Description	MRP* ₹ / Unit	Pack
---------	-------------	------------------	------

Magnesium cover plates with Overmoulded frame

5768 44	Magnesium plate - 6 module	872	5/30
5768 45	Magnesium plate - 8 module	960	5/30
5768 46	Magnesium plate - 2x4 module	1010	2/20
5768 47	Magnesium plate - 2x6 module	1490	2/16

Champagne cover plates with Overmoulded frame

5768 48	Champagne plate - 2 module	430	10/100
5768 49	Champagne plate - 3 module	454	10/100
5768 50	Champagne plate - 4 module	484	5/50
5768 51	Champagne plate - 6 module	872	5/30
5768 52	Champagne plate - 8 module	960	5/30
5768 53	Champagne plate - 2x4 module	1010	2/20
5768 54	Champagne plate - 2x6 module	1490	2/16

Dark Bronze cover plates with Overmoulded frame

5768 55	Dark Bronze plate - 2 module	430	10/100
5768 56	Dark Bronze plate - 3 module	454	10/100
5768 57	Dark Bronze plate - 4 module	484	5/50
5768 58	Dark Bronze plate - 6 module	872	5/30
5768 59	Dark Bronze plate - 8 module	960	5/30
5768 60	Dark Bronze plate - 2x4 module	1010	2/20
5768 61	Dark Bronze plate - 2x6 module	1490	2/16

Mirror finish cover plates with Overmoulded frame

5759 03	Mirror black plate - 2 module	1812	1/5/30
5759 13	Mirror black plate - 3 module	1936	1/20
5759 23	Mirror black plate - 4 module	2060	1/20
5759 33	Mirror black plate - 6 module	3730	1/5
5765 83	Mirror black plate - 8 module	4120	1/5
5759 43	Mirror black plate - 2x4 module	4858	1/10
5759 53	Mirror black plate - 2x6 module	6422	1/8
5759 04	Mirror white plate - 2 module	1812	1/5/30
5759 14	Mirror white plate - 3 module	1936	1/20
5759 24	Mirror white plate - 4 module	2060	1/20
5759 34	Mirror white plate - 6 module	3730	1/5
5765 84	Mirror white plate - 8 module	4120	1/5
5759 44	Mirror white plate - 2x4 module	4958	1/10
5759 54	Mirror white plate - 2x6 module	6422	1/8
5768 62	Green Apple plate - 2 module	1812	1/5/30
5768 63	Green Apple plate - 3 module	1936	1/20
5768 64	Green Apple plate - 4 module	2060	1/20
5768 65	Green Apple plate - 6 module	3730	1/5
5768 66	Green Apple plate - 8 module	4120	1/5
5768 67	Green Apple plate - 2x4 module	4958	1/10
5768 68	Green Apple plate - 2x6 module	6422	1/8

Graphic cover plates with overmoulded frames

5763 01	Graphic casual plate - 2 module	2208	1/5/30
5763 21	Graphic casual plate - 3 module	2364	1/20
5763 41	Graphic casual plate - 4 module	2520	1/20
5763 61	Graphic casual plate - 6 module	4578	1/5
5763 91	Graphic casual plate - 8 module	5038	1/5
5768 97	Graphic casual plate - 2x4 module	6048	1/10
5768 98	Graphic casual plate - 2x6 module	7860	1/8

Bold Cat.Nos are products normally available with Legrand (India) Stockists. Cat.Nos that are not bold - delivery within 4 - 8 weeks from the date of order. Bold packing quantity is our mandatory packing. Orders to be placed by Legrand (India) Stockist in multiples of the same.

Arteor™ round cover plates

Cat.Nos	Description	MRP* ₹ / Unit	Pack
---------	-------------	------------------	------

Round cover plates Silver Baroque cover plates with Overmoulded frame

5768 69	Silver Baroque plate - 2 module	2208	1/5/30
5768 70	Silver Baroque plate - 3 module	2364	1/20
5768 71	Silver Baroque plate - 4 module	2520	1/20
5768 72	Silver Baroque plate - 6 module	4578	1/5
5768 73	Silver Baroque plate - 8 module	5038	1/5
5768 74	Silver Baroque plate - 2x4 module	6048	1/10
5768 75	Silver Baroque plate - 2x6 module	7860	1/8

Dark Baroque cover plates with Overmoulded frame

5768 76	Dark Baroque plate - 2 module	2208	1/5/30
5768 77	Dark Baroque plate - 3 module	2364	1/20
5768 78	Dark Baroque plate - 4 module	2520	1/20
5768 79	Dark Baroque plate - 6 module	4578	1/5
5768 80	Dark Baroque plate - 8 module	5038	1/5
5768 81	Dark Baroque plate - 2x4 module	6048	1/10
5768 82	Dark Baroque plate - 2x6 module	7860	1/8

Metal finish cover plates with Overmoulded frame

5763 00	Gold brass plate - 2 module	2946	1/5/30
5763 20	Gold brass plate - 3 module	3148	1/20
5763 40	Gold brass plate - 4 module	3360	1/20
5763 60	Gold brass plate - 6 module	6102	1/5
5763 90	Gold brass plate - 8 module	6722	1/5
5759 06	Stainless steel plate - 2 module	2946	1/5/30
5759 16	Stainless steel plate - 3 module	3148	1/20
5759 26	Stainless steel plate - 4 module	3360	1/20
5759 36	Stainless steel plate - 6 module	6102	1/5
5765 86	Stainless steel plate - 8 module	6722	1/5
5759 46	Stainless steel plate - 2x4 module	8504	1/10
5759 56	Stainless steel plate - 2x6 module	10464	1/8

Wood cover plates with Overmoulded frame

5768 90	Grey Oak plate - 2 module	1550	1/5/30
5768 91	Grey Oak plate - 3 module	2294	1/20
5768 92	Grey Oak plate - 4 module	2380	1/20
5768 93	Grey Oak plate - 6 module	3378	1/5
5768 94	Grey Oak plate - 8 module	4116	1/5
5768 95	Grey Oak plate - 2x4 module	4400	1/10
5768 96	Grey Oak plate - 2x6 module	5634	1/8

Signature cover plates with Overmoulded frame

5768 83	Cube plate - 2 module	4876	1/5/30
5768 84	Cube plate - 3 module	5928	1/20
5768 85	Cube plate - 4 module	6036	1/20
5768 86	Cube plate - 6 module	7726	1/5
5768 87	Cube plate - 8 module	8194	1/5
5768 88	Cube plate - 2x4 module	11400	1/10
5768 89	Cube plate - 2x6 module	12900	1/8

* MRP - Maximum Retail Price Inclusive of all taxes including GST.
Red Cat.Nos - new products

Arteor™ round cover plates

Cat.Nos	Description	MRP* ₹ / Unit	Pack
---------	-------------	------------------	------

Accessories

Plastic surface boxes

5734 91	Surface box - 1/2 module	108	10/50
5735 20	Surface box - 3 module	136	5/35
5735 70	Surface box - 4 module	166	5/25
5735 71	Surface box - 6 module	200	1/10
5723 94	Surface box - 8 module	224	1/10
5735 74	Surface box - 2x4 module	278	2/10
5735 72	Surface box - 12/16 module	702	2/10
5735 73	Surface box - 18/24 module	744	2/8

Metal flush boxes

6890 07	Metal flush mounting Box - 1/2 module	108	40
6890 08	Metal flush mounting Box - 3 module	108	40
6890 09	Metal flush mounting Box - 4 module	148	40
6890 10	Metal flush mounting Box - 6 module	232	40
6890 42	Metal flush mounting Box - 8 module	272	40
6890 31	Metal flush mounting Box - 4x2 module	270	20
6890 11	Metal flush mounting Box - 12 /16 module	406	10
6890 12	Metal flush mounting Box - 18 / 24 module	514	10

IP 55 Plexo box and accessories

0696 51	Grey Plexo box for 2 module	272	10/100
0696 72	Grey Plexo box for 2 x 2 module use two nos. of 0695 80	884	5/50
0696 80	use two nos. of 0695 80 Grey Plexo box for 2 x 2 x 2 module	1186	5/25
0696 89	White Plexo box for 2 module	332	10/100

IP 55 Plexo box and accessories

0695 80	Grey/White adaptor for IP 55 Plexo with smoked polycarbonate flap for 2 modules	1016	10/100
6846 38	Grey Plexo box & adaptor with transparent flap for 3 modules, IP 66	4062	1

IP 55 Plexo box with PVC membrane

6806 11	Grey Plexo box & adaptor with PVC membrane - 1 module	894	10
6806 12	Grey Plexo box & adaptor with PVC membrane - module	916	10
6806 13	Grey Plexo box & adaptor with PVC membrane - module	1218	10
6806 14	Grey Plexo box & adaptor with PVC membrane - 4 module	1826	5
6806 19	Grey Plexo box & adaptor with PVC membrane - 2 row x 4 module	2966	5
6806 33	Grey Plexo flush adaptor with membrane for 3 module Arteor™ box	976	20



5735 70



6890 07



6890 08



6890 09



6890 10



0695 80



6846 38



6806 12



6806 13



6806 14

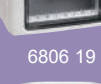

6806 19

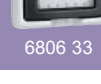

6806 33

Bold Cat.Nos are products normally available with Legrand (India) Stockists. Cat.Nos that are not bold - delivery within 4 - 8 weeks from the date of order. Bold packing quantity is our mandatory packing. Orders to be placed by Legrand (India) Stockist in multiples of the same.

ARTEOR™ IoT

ADD A TOUCH OF SMARTNESS

THE SMART RADIO SOLUTION

Arteor lot offer, a radio-based solution for the connected home. The intelligent products communicate with one another via radio ZigBee 3.0 (2.4 GHz waveband). This means there is no need for specific or extensive cabling. Also, although the range only contains a few products, these can be used to create lots of individual solutions for a more customized feel at home.

SIMPLE, ADAPTABLE, OPEN

Radio-based Arteor has been designed and developed as a simple solution to make every house more individual, convenient and secure. Simple for planners, who are able to integrate many useful functions without having to provide for complicated cabling. Simple for installers, who are able to install the system without a great deal of effort or specialist knowledge. Simple for users, who will find it convenient to operate, easy to extend and are able to make changes at any time.



THE HOME + CONTROL APP FOR SMARTPHONE OR TABLET

The app on the smartphone or tablet opens up new options: monitoring of instantaneous power consumption, remote surveillance of the connected home, and control over various functions when the user is out and about.

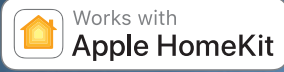
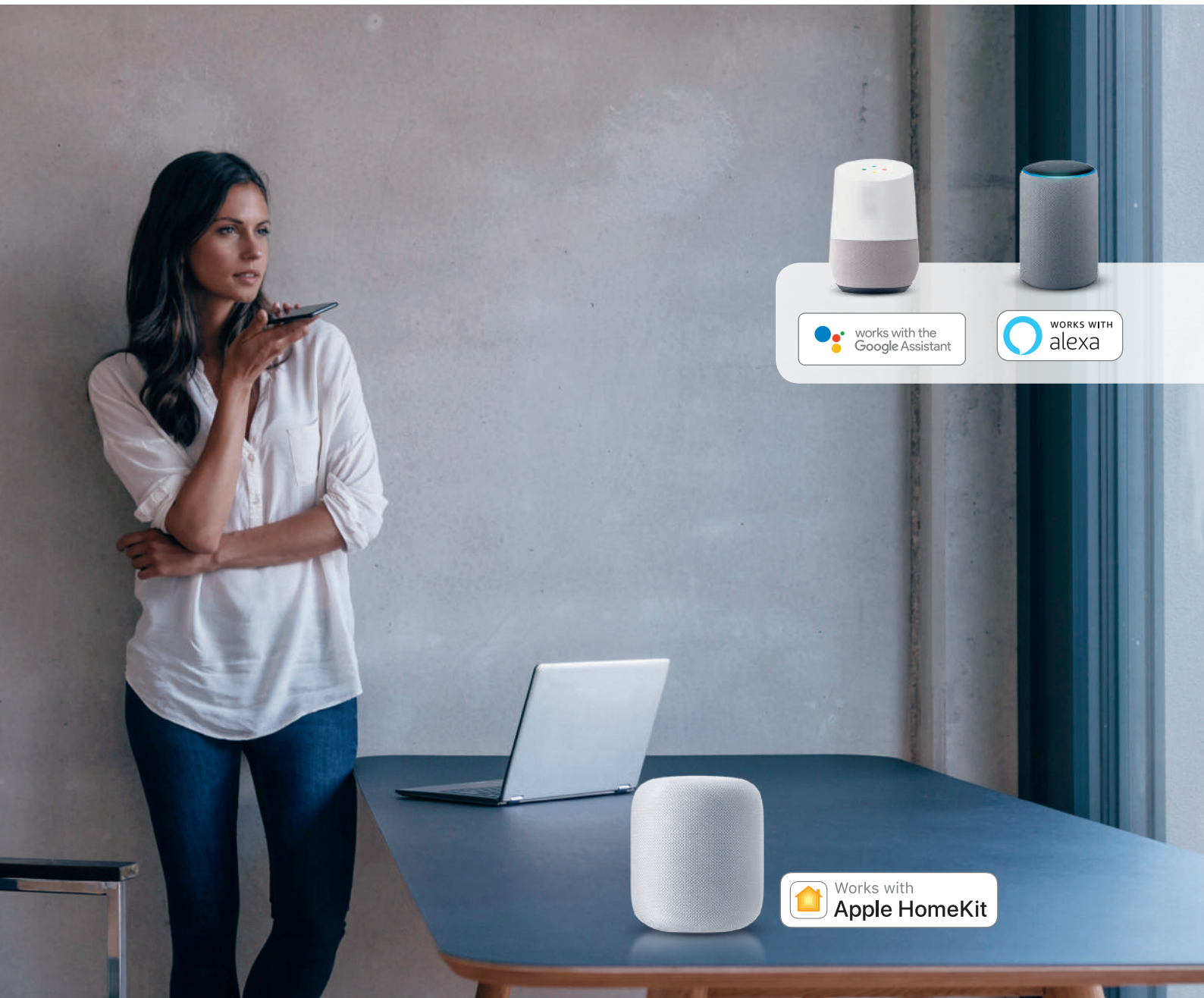

LOCAL CONTROL GUARANTEED

Of course, all functions can still be used in the traditional way via switches on the wall. If furniture needs to be rearranged or small children need to be able to reach a switch, the wireless switches can be repositioned easily at any time.



Home + Control App

iPhone, iPod and iPad are registered trademarks of Apple Inc, registered in the US and other countries. HomeKit is a trademark of Apple Inc. App store is a service mark of Apple Inc., Google, Android, Google Play, and the Google Play logo are trademarks of Google LLC. Amazon, Alexa and all related logos are trademarks of Amazon.com, Inc. or its affiliates.

Arteor™ Connected Home - white mechanism

Cat.Nos	Description	MRP* ₹ / Unit	Pack
---------	-------------	------------------	------

Connected light switches

5742 01	Switch with neutral, wired, 1 module	7372	1/24
5742 02	Switch without neutral, with dimmer option, wired, 2 modules	9922	1/12

Connected outlets

5742 00	Connected socket outlet module - 16A - 240VA - 3680 W, 1 module	7718	1/12
---------	-----------------------------------------------------------------	------	------

Connected curtain/roller blind switches

5742 04	Connected curtain/roller blind switch wired, 1 module	8308	1/24
---------	-------------------------------------------------------	------	------

Connected gateway pack

5742 09	Connected gateway + Master home away wireless switch wired, 2 module	17366	1/4
---------	----------------------------------------------------------------------	-------	-----

Connected wireless controls

5742 05	Wireless light switch	3650	1/10
5742 07	Curtain/roller blind wireless switch	4212	1/10

Connected wireless scene switches

5742 06	Home/Away wireless master switch	4212	1/10
5742 08	Wake up/Sleep wireless switch	4212	1/10

Magnesium Mechanism connected light switches

5742 20	Switch with neutral, wired, 1 module	8476	1/24
5742 21	Switch without neutral, with dimmer option, wired, 2 modules	11410	1/12

Connected outlets

5742 28	Connected socket outlet module - 16A - 240VA - 3680 W, 1 module	8876	1/12
---------	-----------------------------------------------------------------	------	------

Connected curtain/roller blind switches

5742 22	Connected curtain/roller blind switch wired, 1 module	9552	1/24
---------	-------------------------------------------------------	------	------

Connected gateway pack

5742 27	Connected gateway + Master home away wireless switch wired, 2 module	19970	1/4
---------	----------------------------------------------------------------------	-------	-----

Connected wireless controls

5742 23	Wireless light switch - 1-gang	4198	1/10
5742 25	Curtain/roller blind wireless switch	4844	1/10

Connected wireless scene switches

5742 24	Home/Away wireless master switch	4844	1/10
---------	----------------------------------	------	------

* MRP - Maximum Retail Price Inclusive of all taxes including GST.
 * To be Introduced Shortly
 (1) Supplied with white plate
 ■ Price available on request

Arteor™ square - white mechanisms

Cat.Nos	Description	MRP* ₹ / Unit	Pack
---------	-------------	------------------	------

Connected wireless scene switches

5742 26	Wake up/Sleep wireless switch	4844	1/10
---------	-------------------------------	------	------

Champagne Mechanism Connected light switches

5742 29	Switch with neutral, wired, 1 module	8476	1/24
5742 30	Switch without neutral, with dimmer option, wired, 2 modules	11410	1/12

Connected outlets

5742 37	Connected socket outlet module - 16A - 240VA - 3680 W, 1 module	8876	1/12
---------	-----------------------------------------------------------------	------	------

Connected curtain/roller blind switches

5742 31	Connected curtain/roller blind switch wired, 1 module	9552	1/24
---------	-------------------------------------------------------	------	------

Connected gateway pack

5742 36	Connected gateway + Master home away wireless switch wired, 2 module	19970	1/4
---------	----------------------------------------------------------------------	-------	-----

Connected wireless controls

5742 32	Wireless light switch - 1-gang	4198	1/10
5742 34	Curtain/roller blind wireless switch	4844	1/10

Connected wireless scene switches

5742 33	Home/Away wireless master switch	4844	1/10
5742 35	Wake up/Sleep wireless switch	4844	1/10

Micro module switch

5742 43	Micro module switch with neutral, 300 W	5882	1/24
---------	-----------------------------------------	------	------

COVER PLATES

White cover plates with Overmoulded frame

5758 98	White plate - 1 module	260	10/100
5758 99	White plate - 2 module	270	10/100
5759 60	White plate - 3 module	314	10/100
5759 65	White plate - 4 module	360	5/50
5759 94	White plate - 6 module	494	5/30
5759 95	White plate - 8 module	584	5/30
5759 96	White plate - 2x4 module	854	2/20
5759 97	White plate - 2x6 module	1136	2/16
5759 98	White plate - 2x8 module	1248	2/16
5759 99	White plate - 3x6 module	1470	2/12

Bold Cat.Nos are products normally available with Legrand (India) Stockists. Cat.Nos that are not bold - delivery within 4 - 8 weeks from the date of order. Bold packing quantity is our mandatory packing. Orders to be placed by Legrand (India) Stockist in multiples of the same.

MYRIUS™

MORE IS ON



The Myrius's range of plates is crafted with unique features & flawless designs, it perfectly defines aestheticism. These minimalistic and flawless designs are available in neutral tones of grainy matte black and glossy white to suit any décor.



Black Beauty

A mystic black shade with a grainy matte finish truly complements any décor.



Snowy White

Its gleaming white shade and a perfect glossy finish creates a soothing décor.



MORE AESTHETICS

Flat, sleek and smooth, Myrius with its curved edges gives it a distinct and appealing look to everyone. Moreover, its minimalistic design makes it look absolutely stunning and desirable. But what makes Myrius truly beautiful is a classic black and white shade that offers an aura of comfort and timelessness.



VSP - Voltage Surge protectors

- Protects electrical devices like laptops, computers, printers and other office equipments from voltage surge
- Blends very well with the modular range of wiring devices



Motion sensor

- Infrared detectors that detect human movements
- Programmed to automatically switch the device on and switch off when not in use, thus, saves energy



Motor Starter

- Complete protection against overload
- Aesthetically appealing
- For ACs/Geysers etc.



Skirting light

- Fitted into the walls at skirting level
- Provides a dim lighting
- Creates a path light during night
- Uses LEDs that saves energy



Remote control switch for light and fan

- Can control 4 lights & 1 fan
- 10 different speed options for fan
- Night lamp on product panel with manual operation option for all functions

MYRIUS™

MORE IS ON

Myrius range of wiring accessories is a classic creation to increase the customer's comfort and improve the work environment. This wide range of innovative products offers solutions for residential, commercial and hospitality projects, thus making it a range that caters to everyone's needs.



Fan regulator



TV/SAT/FM socket



Telephone Socket



Light Marking



AV Connector



RJ 45 Data Socket



Projector connector



Key Fob Switch



Do not disturb Switch

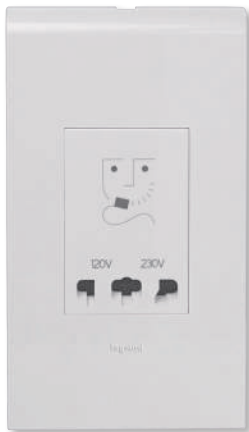

Shaver socket



USB Charger



Modular MCB



Myrius™ mechanisms - white

Cat.Nos	Description	MRP* ₹ / Unit	Pack
---------	-------------	------------------	------

Switches - 6 A - 230 VA

6730 00	6 A switch 1 W - 1 module	136	20/200
6730 01	6 A switch 2 W - 1 module	212	20/200
6730 02	6 A switch 1 W - 1 module with indicator	196	20/200
6730 03	6 A switch 1 W - 1 module with "Light" marking	166	20/200
6730 04	6 A switch 1 W - 1 module with "Fan" marking	166	20/200

Switches - 10 A - 230 VA

6730 05	10 A switch 1 W - 2 module	246	10/100
6730 06	10 A switch 2 W - 2 module	288	10/100
6730 17	10 A intermediate - 2 module	1584	10/100
6730 07	10 A switch 1 W with indicator - 2 module	304	10/100

Switches - 16 A - 230 VA

6730 08	16 A switch 1 W - 1 module	276	20/200
6730 09	16 A switch 2 W - 1 module	316	20/200
6730 10	16 A switch 1 W with indicator - 1 module	334	20/200

Switches - 20 A - 230 VA

6730 11	20 A 1 W switch - 1 module	366	20/200
6730 12	20 A DP 1 W switch - 2 module	560	10/100
6730 13	20 A DP 1 W switch with indicator - 2 module	594	10/100
6730 14	20 A 2 W switch - 2 module	620	10/100

Switches - 25 A - 230 VA

6730 15	25 A SP 1 W switch with indicator - 1 module	410	20/200
---------	----------------------------------------------	-----	--------

Switches - 32 A - 230 VA

6730 16	32 A DP switch with indicator - 2 module	918	10/100
---------	------------------------------------------	-----	--------

* MRP - Maximum Retail Price Inclusive of all taxes including GST.

Myrius™ mechanisms - white

Cat.Nos	Description	MRP* ₹ / Unit	Pack
---------	-------------	------------------	------

Push buttons

6730 18	6 A push button SP - 1 module	236	20/200
6730 19	6 A push button SP with indicator - 1 module	304	20/200
6730 20	6 A bell push - 1 module	232	20/200
6730 21	6 A bell push with indicator - 1 module	304	20/200
6730 22	6 A bell push - 2 module	352	10/100
6730 23	6 A bell push with indicator - 2 module	410	10/100

Accessories for switches with indicator

6732 44	Lamp for switches / push buttons	50	5/50
---------	----------------------------------	----	------

Socket - 230 VA

6730 41	6/16 A 2 Pin Euro US socket - 1 module	320	20/200
6730 42	16 A 3 Pin switched socket - 3 module	1046	5/50
6730 43	Multistandard socket 6/10/13 A - 2/3 pin for 250 V AC 15 A for 127 V type - 2 pin 2 module	352	10/100
6730 44	6 A 5 Pin universal socket - 2 module	302	20/200
6730 83	6/16 A socket - 3 module	488	5/50
6730 45	6/16 A socket - 2 module	408	10/100
6730 46	6/16 A - Euro socket - 2 module	470	10/100
6730 47	25 A socket - 2 module	516	10/100

Power unit

6730 74	Power strip - 8 module 6 A (2 nos.) + 16 A socket (1 no.) + 16 A switch with indicator (1 no.)	2386	1/10
6730 75	Power strip - 8 module 5 Pin 6 A (3 nos.) + 16 A switch with indicator (1 no.)	1872	1/10
6730 76	Power strip - 8 module multistd socket (3 nos.) + 16 A switch (1 no.)	1844	1/10

Bold Cat.Nos are products normally available with Legrand (India) Stockists. Cat.Nos that are not bold - delivery within 4 - 8 weeks from the date of order. Bold packing quantity is our mandatory packing. Orders to be placed by Legrand (India) Stockist in multiples of the same.

Myrius™ mechanisms - white

Cat.Nos	Description	MRP* ₹ / Unit	Pack
---------	-------------	------------------	------

Dimmer & regulator

6730 24	Rotary dimmer 400 W - 1 module	1010	1/5/50
6730 25	Rotary dimmer 650 W - 3 module	2122	1/10
6730 26	Compact fluorescent lamp dimmer - 2 module	3026	1/10
6730 27	Fan step regulator 100 W - 1 module	788	1/5/50
6730 29	Fan step regulator 100 W - 2 module	904	1/10/100
6730 28	Fan step regulator 120 W - 2 module	976	1/10/100
6730 77	Fan step regulator - 2 module for energy saving fans	946	1/10/100

Emergency light

0785 12	Emergency light unit - 2 module	5892	1/1
---------	---------------------------------	------	-----

Indicators

0785 73	Triangular bulkhead - Blue - 2 module	258	1/1
0785 71	Triangular bulkhead - colourless - 2 module	258	1/1
0785 72	Triangular bulkhead - green - 2 module	282	1/1
0785 70	Triangular bulkhead - red - 2 module	282	1/1

Skirting light

6730 36	Skirting light with white LED - 3 module	764	1/5/25
---------	------------------------------------------	-----	--------

Bell indicator

6730 33	Bell indicator - 240 VA - 1 module	1106	20/200
---------	------------------------------------	------	--------

Buzzer

6730 34	Buzzer - 230 VA - 1 module	1088	20/200
---------	----------------------------	------	--------

Remote unit

6730 73	Remote control switch - 4 module	7780	1/5/20
---------	----------------------------------	------	--------

Hospitality functions Key FOB switch

6730 37	15 A key card switch monobloc with plate - 2 M	3650	1/10
6732 37	15 A key card switch monobloc with new plate - 2 M White	4018	1/10
6730 38	Only key fob for switch Cat.Nos 6730 37 & 6732 37	174	1/10/100

Myrius™ mechanisms - white

Cat.Nos	Description	MRP* ₹ / Unit	Pack
---------	-------------	------------------	------

"Do Not Distrub" and MMR control unit

6730 39	External unit - 1+1 module	1556	10/100
6730 40	Internal unit - 1+1 module	1040	10/100

Shaver socket

6730 49	Shaver Socket 230 V / 120 - 230 V monobloc with plate - 4 M	4594	1/5/20
6730 79	Shaver Socket 230 V / 120 - 230 V monobloc with new plate - 4 M White	4814	1/5

Sockets and connectors

TV socket

6730 50	TV socket - 1 module	204	20/200
---------	----------------------	-----	--------

Data & voice

6730 52	RJ-11 telephone socket with transparent shutter 1 module	202	20/200
6730 53	RJ-11 double telephone socket with shutter 1 module	308	20/200
6730 54	UTP cat 5e information outlets toolless system 1 module	474	20/200
6730 55	UTP cat 6 - 1 module	702	20/200
6730 56	UTP cat 6 - 2 module	714	10/100

USB chargers (IS13252 (Part 1) / IEC 60950-1)

6730 80	USB Charger 1M 1000mA	1152	10/100
6731 62*	USB Charger 1M 1500mA	1324	10/100
6731 78	Double USB Charger 2M 2400mA	1856	1/10/100

Audio & video connector

6730 57	3 x female RCA 1 module	2726	1/10
---------	-------------------------	------	------

Sound (Volume controller)

6730 63	Suitable for 8 Ohms, 3 Watts (RNS) speaker - 2 module	1300	1/10/100
---------	-------------------------------------------------------	------	----------

Protectors and accessories Motor starter

6730 30	16 A motor starter 2 module	650	1/10/100
6730 31	25 A motor starter 2 module	666	1/10/100

Modular MCB (IS : 60898-1:2002)

6730 64	16 A MCB SP 1M C curve	394	1/10/100
6730 65	20 A MCB SP 1M C curve	394	1/10/100
6732 05	25 A MCB SP 1M C curve	394	1/10/100
6732 07	32A MCB SP 1M C curve	394	1/10/100

* MRP - Maximum Retail Price Inclusive of all taxes including GST.
* To be Introduced Shortly

Bold Cat.Nos are products normally available with Legrand (India) Stockists. Cat.Nos that are not bold - delivery within 4 - 8 weeks from the date of order. Bold packing quantity is our mandatory packing. Orders to be placed by Legrand (India) Stockist in multiples of the same.

Myrius™
mechanisms - white

Cat.Nos	Description	MRP* ₹ / Unit	Pack
---------	-------------	------------------	------

RCBO

6730 78	Single pole + Neutral - 30 mA, 16 A - 230 VA 2 module	8664	1/1
---------	----------------------------------------------------------	------	-----

Accessories

6730 60	Cable outlet - 8 mm 1 module	250	20/200
6730 61	Blanking plate - 1 module	44	20/200
6730 62	Blanking plate - 2 module	50	10/100
0802 90	Panel mounting support 1 module	220	10/200
0802 91	Panel mounting support 2 module	226	10/200

Myrius antibacterial switches & accessories - white

6730 84	6 A switch 1 W - 1 module	186	20/200
6730 85	6 A switch 2 W - 1 module	250	20/200
6730 86	6 A bell push - 1 module	280	20/200
6730 89	16 A switch 1 way - 1 module	334	20/200
6730 90	16 A switch 2 way - 1 module	388	20/200
6730 92	Fan regulator 120 W - 2 module	1198	1/10/100
6730 93	Multistandard socket - 2 module	420	10/100
6730 94	6 A 5 pin universal socket 2 module	364	20/200
6730 95	6/16 A socket - 3 module	594	5/50
0787 00	Equipotential socket 1 module antibacterial	1644	1/10
6730 98	T.V. socket - 1 module	246	20/200
6730 99	RJ -11 telephone socket - 1 module	246	20/200
6730 81	RJ-45 Cat 6 UTP - 1 module	862	20/200
6730 82	Blanking plate - 1 module	44	20/200
6732 45	1 module plate + frame 1 module	178	20/200
6732 46	2 module plate + frame 2 module	200	20/200
6732 47	3 module plate + frame 3 module	224	10/100
6732 48	4 module plate + frame 4 module	240	10/100
6732 49	8 module plate + frame (horizontal) 8 module	462	5/50
6732 50	8 module plate + frame (4x2) 8 module	580	5/25
6732 52	16 module plate + frame 16 module	808	1/10

* MRP - Maximum Retail Price Inclusive of all taxes including GST.

MYRIUS ANTI-BACTERIAL

MORE FOR YOUR WELLNESS



Myrius anti-bacterial products offer anti-bacterial protection. The composition of the product contain Ag+ ions that eliminates the proliferation of bacteria on contact with the surface of the product. It has a smooth and straight design that facilitates in reducing the dust accumulation. It is self disinfecting throughout its lifespan.

- Extremely useful in agri-food premises, healthcare environments & premises with high risk in terms of people's fragility.
- Special protection for the health and hygiene market in the form of an equipotential socket for earthing devices, application to connection of hospital beds and trolleys to medical apparatus to avoid all risk of potential difference during the medical care.

Myrius™ mechanisms - white

Cat.Nos	Description	MRP* ₹ / Unit	Pack
---------	-------------	------------------	------

Myrius™

mechanisms - black Switches – 6 A - 230 VA

6731 00	6 A switch 1 W 1 module	166	20/200
6731 01	6 A switch 2 W 1 module	236	20/200
6731 02	6 A switch 1 W with indicator - 1 module	260	20/200
6731 03	6 A switch 1 W with "Light" marking 1 module	200	20/200
6731 04	6 A switch 1 W with "Fan" marking 1 module	200	20/200

Switches – 10 A - 230 VA

6731 05	10 A switch 1 W 2 module	294	10/100
6731 06	10 A switch 2 W 2 module	316	10/100
6731 17	10 A intermediate switch 2 module	1826	10/100
6731 07	10 A switch 1 W with indicator - 2 module	340	10/100

Switches – 16 A - 230 VA

6731 08	16 A switch 1 way 1 module	308	20/200
6731 09	16 A switch 2 way 1 module	372	20/200
6731 10	16 A switch 1 way with indicator - 1 module	388	20/200

Switches – 20 A - 230 VA

6731 11	20 A 1 W switch 1 module	414	20/200
6731 12	20 A DP 1 W switch 2 module	648	10/100
6731 13	20 A DP 1 W switch with indicator - 2 module	686	10/100
6731 14	20 A 2 W switch 2 module	708	10/100

Switches – 25 A - 230 VA

6731 15	25 A SP 1 W switch with indicator - 1 module	476	20/200
---------	----------------------------------------------------	-----	--------



6731 01



6731 02



6731 05



6731 10



6731 12



6731 15

Myrius™ mechanisms - black

Cat.Nos	Description	MRP* ₹ / Unit	Pack
---------	-------------	------------------	------

Switches – 32 A - 230 VA

6731 16	32 A DP switch with indicator - 2 module	1060	10/100
---------	------------------------------------------------	------	--------

Push buttons

6731 18	6 A push button SP 1 module	274	20/200
6731 19	6 A push button SP with indicator - 1 module	346	20/200
6731 20	6 A bell push - 1 module	260	20/200
6731 21	6 A bell push with indicator - 1 module	346	20/200
6731 22	6 A bell push 2 module	398	10/100
6731 23	6 A bell push with indicator - 2 module	476	10/100

Accessories for switches with indicator

6732 44	Lamp for switches / push buttons	50	5/50
---------	-------------------------------------	----	------

Socket - black

6731 41	6/16 A 2 pin Euro US socket - 1 module	370	20/200
6731 42	16 A 3 pin switched socket - 3 module	1196	5/50
6731 43	Multistandard socket 6/10/13 A - 2/3 pin for 250 V AC 15 A for 127 V type - 2 pin 2 module	408	10/100
6731 44	6 A 5 Pin with universal socket 2 module	330	20/200
6731 83	6/16 A socket 3 module	562	5/50
6731 45	6/16 A socket 2 module	478	10/100
6731 47	25 A socket - 2 module	586	10/100

Socket - red

6730 48	16 A switched socket 3 module	1062	5/50
---------	----------------------------------	------	------

Dimmers & regulators

6731 24	Rotary dimmer 400 W 1 module	1158	1/5/50
6731 25	Rotary dimmer 650 W 3 module	2450	1/10
6731 27	Fan step regulator 100 W 1 module	906	1/5/50
6731 29	Fan step regulator 100 W 2 module	1026	1/10/100
6731 28	Fan step regulator 120 W 2 module	1126	1/10/100
6731 77	Fan step regulator - 2 module for energy saving fans	1088	1/10/100



6731 21



6731 22



6731 41



6731 42



6731 44



6730 48



6731 25



6731 27

* MRP - Maximum Retail Price Inclusive of all taxes including GST.

Bold Cat.Nos are products normally available with Legrand (India) Stockists. Cat.Nos that are not bold - delivery within 4 - 8 weeks from the date of order. Bold packing quantity is our mandatory packing. Orders to be placed by Legrand (India) Stockist in multiples of the same.

Myrius™ mechanisms - black

Cat.Nos	Description	MRP* ₹ / Unit	Pack
---------	-------------	---------------------	------

Skirting light

6731 36	Skirting light with white LED - 3 module	880	1/5/25
---------	------------------------------------------	-----	--------

Bell indicator

6731 33	Bell Indicator- 240 VA 1 module	1290	20/200
---------	------------------------------------	------	--------

Buzzer

6731 34	Buzzer - 230 VA sound level 72dB at 1 meter distance 1 module	1254	20/200
---------	---------------------------------------------------------------------	------	--------

Remote unit

6731 73	Remote control switch 4 module	9034	1/5/20
---------	-----------------------------------	------	--------

Hospitality functions Key FOB switch

6731 37	15 A key card switch with timedelay 30 sec. monobloc with plate - 2 M	4196	1/10
6732 67	15 A key card switch monobloc with new plate - 2 M Black	4614	1/10
6730 38	Only key fob for switch Cat.No 6731 37 & 6732 67	174	1/10/100

"Do Not Distrub" and MMR control unit

6731 39	External unit - 1+1 module	1786	10/100
6731 40	Internal unit - 1+1 module	1192	10/100

Shaver socket

6731 49	Shaver socket 220/240 V - 50/60 Hz monobloc with plate - 4 M	5034	1/5/20
6731 79	Shaver socket 230 V / 120 - 230 V monobloc with new plate - 4 M Black	5298	1/5

TV socket

6731 50	TV socket - 1 module	246	20/200
---------	----------------------	-----	--------

Data & voice

6731 52	RJ-11 telephone socket with transparent shutter 1 module	236	20/200
6731 53	RJ-11 double telephone socket with shutter 1 module	360	20/200

Data & voice

6731 54	UTP cat 5e RJ 45 information outlets 1 module	518	20/200
6731 55	UTP cat 6 - 1 module	792	20/200
6731 56	UTP cat 6 - 2 module	800	10/100

Myrius™ mechanisms - black

Cat.Nos	Description	MRP* ₹ / Unit	Pack
---------	-------------	---------------------	------

USB chargers (IS13252 (Part 1) / IEC 60950-1)

6731 80	USB Charger 1M 1000mA	1326	10/100
6731 72#	USB Charger 1M 1500mA	1524	10/100
6732 78	Double USB Charger 2M 2400mA	2134	1/10/100

Connectors and controllers

Audio & video connector

6731 57	3 x female RCA -1 module	3136	1/10
6731 58	3 pole XLR sockets 2 module	2958	10/100

Sound

6731 63	Suitable for 8 Ohms, 8 Ohms, 3 Watts (RNS) speaker - 2 module	1506	1/10/100
---------	---------------------------------------------------------------------	------	----------

Protectors and accessories

Motor starter

6731 30	16 A motor starter- 2 module	748	1/10/100
6731 31	25 A motor starter- 2 module	764	1/10/100

Modular MCB (IS : 60898-1:2002)

6731 64	16A MCB SP 1M C curve	450	1/10/100
6731 65	20A MCB SP 1M C curve	450	1/10/100

Accessories

6731 60	Cable outlet - 8mm 1 module	294	20/200
6731 61	Blanking plate-1 module	48	20/200

Plastic plates

White plates with frame

6732 01	1 Module plate + Frame	160	20/200
6732 02	2 Module plate + Frame	168	20/200
6732 03	3 Module plate + Frame	180	10/100
6732 04	4 Module plate + Frame	200	10/100
6732 06	6 Module plate + Frame	352	5/50
6732 08	8 Module plate + Frame (horizontal)	384	5/50
6732 09	8 Module plate + Frame (4x2)	482	5/25
6732 12	12 Module plate + Frame	582	1/10
6732 16	16 Module plate + Frame	676	1/10
6732 18	18 Module plate + Frame	778	1/10

Bold Cat.Nos are products normally available with Legrand (India) Stockists. Cat.Nos that are not bold - delivery within 4 - 8 weeks from the date of order. Bold packing quantity is our mandatory packing. Orders to be placed by Legrand (India) Stockist in multiples of the same.



6731 36



6731 33



6731 34



6731 73



6731 37



6732 67



6730 38



6731 49



6731 79



6731 50

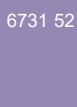

6731 52



6731 53



6731 63



6732 01



6732 03

Myrius™ plastic plates



Cat.Nos	Description	MRP* ₹ / Unit	Pack
---------	-------------	------------------	------

New white plates with frame*

6732 11	1 Module plate + Frame	170	20/200
6732 42	2 Module plate + Frame	184	20/200
6732 13	3 Module plate + Frame	198	10/100
6732 14	4 Module plate + Frame	212	10/100
6732 66	6 Module plate + Frame	412	5/50
6732 68	8 Module plate + Frame (Horizontal)	440	5/50
6732 69	8 Module plate + Frame (4x2)	550	5/25
6732 62	12 Module plate + Frame	668	1/10
6732 56	16 Module plate + Frame	782	1/10
6732 58	18 Module plate + Frame	896	1/10

Black plates with frame

6732 21	1 Module plate + Frame	272	20/200
6732 22	2 Module plate + Frame	294	20/200
6732 23	3 Module plate + Frame	308	10/100
6732 24	4 Module plate + Frame	348	10/100
6732 26	6 Module plate + Frame	600	5/50
6732 28	8 Module plate + Frame (Horizontal)	666	5/50
6732 29	8 Module plate + Frame (4 x 2)	822	5/25
6732 32	12 Module plate + Frame	984	1/10
6732 36	16 Module plate + Frame	1156	1/10
6732 38	18 Module plate + Frame	1308	1/10

New black plates with frame*

6732 31	1 Module plate + Frame	306	20/200
6732 82	2 Module plate + Frame	342	20/200
6732 33	3 Module plate + Frame	362	10/100
6732 34	4 Module plate + Frame	396	10/100
6732 86	6 Module plate + Frame	694	5/50
6732 88	8 Module plate + Frame (Horizontal)	758	5/50
6732 89	8 Module plate + Frame (4 x 2)	948	5/25
6732 92	12 Module plate + Frame	1138	1/10
6732 96	16 Module plate + Frame	1328	1/10
6732 98	18 Module plate + Frame	1498	1/10

Mounting boxes

Flush mounting boxes

6890 07	Flush box - 1/2 module	108	40
6890 08	Flush box - 3 module	108	40
6890 09	Flush box - 4 module	148	40

* MRP - Maximum Retail Price Inclusive of all taxes including GST.
The new plate range will be introduced shortly.

Cat.Nos	Description	MRP* ₹ / Unit	Pack
---------	-------------	------------------	------

Flush mounting boxes

6890 10	Flush box - 6 module	232	40
6890 42	Flush box - 8 module	272	40
6890 31	Flush box - 8 module (2 row x 4)	270	20
6890 11	Flush box - 12/16 (2 row x 6) module (metal box)	406	10
6890 12	Flush box - 18 module (metal box)	514	10

Surface mounting boxes

6733 02	Surface box - 1/2 module	74	10/50
6733 03	Surface box - 3 module	88	5/35
6733 04	Surface box - 4 module	102	5/25
6733 06	Surface box - 6 module	130	1/10
6733 08	Surface box - 8 module	196	1/5
6733 05	Surface box - 8 (2 row x 4) module	190	1/5

Metal surface boxes

6890 21	Metal surface box - 12/16 (2 row x 6) module	468	1/6
6890 22	Metal surface box - 18 module	494	1/4



6890 11

Myrius™

More is on.

Guarantee

- The Company, at its discretion, will replace products if they have any manufacturing defect within 10 years for switches (without LED lamp) and power sockets. For all other Myrius™ wiring accessories the guarantee will be 2 years.
- The above guarantee is applicable when the devices are used in Legrand metal flush boxes. Otherwise the guarantee period will be reduced by 50%.
- The guarantee is only applicable when the products are installed as per the Company's instructions and not tampered in any manner.
- The guarantee states the Company's entire liability. It does not extend to cover consequential loss or damage or installation costs arising from defective products.

* MRP - Maximum Retail Price Inclusive of all taxes including GST.
The new plate range will be introduced shortly.

MYLINC™

A LITTLE TOUCH OF GENIUS

Mylic™ is a complete range of modular wiring accessories. Switches and sockets designed and made in India, keeping everyone's requirements in mind. Whether it's safety, reliability, convenience or beauty; Mylic™ is the smart option in modular switch design.



USB Charger



8 Step Fan Regulator



Remote control unit for Light and Fan



Modular MCB



Champagne



Silver Alu



Dark Bronze



Matt Grey



Pearl White



Motor Starter



Skirting Light 2 M



Switch 25 A with indicator



MYLINC™

A LITTLE TOUCH OF GENIUS



Screwless finish & rounded corners that add beauty to any home



Linc-Loc™ intelligent design prevents wrong fitting, misaligned switches and sockets



Laser marking safeguards against fakes



Safety feature for mishap-proof use



Indicators for correct orientation



Front Removal



Stripping Template



ISI marking



CE marking

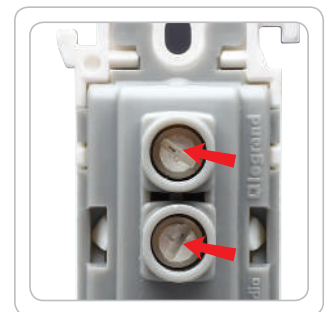

Finger-proof terminals for IP 20 protection against accidental contact

1 lac operations

with a guarantee of 100,000 operations, assuming an average switch is operated 10 times a day, this product is dependable for 27 years.

Mylic™ mechanisms

Cat.Nos	Description	MRP* ₹ / Unit	Pack
---------	-------------	------------------	------

Switches and accessories

Switches 6 A - 250 V AC

6755 01	6 A one-way SP switch - 1 module	90	20/200
6755 02	6 A two-way SP switch - 1 module	160	20/200
6755 03	6 A one-way SP switch with indicator - 1 module	182	20/200

Switches 16 A - 250 V AC

6755 11	16 A one-way SP switch - 1 module	176	20/200
6755 12	16 A two-way SP switch - 1 module	222	20/200
6755 13	16 A one-way SP switch with indicator - 1 module	230	20/200

Switch 25 A - 250 V AC

6759 68	Switch 25 A with indicator - 1 module	274	10/100
---------	----------------------------------------------	-----	--------

Switches 32 A - 250 V AC

6755 26	32 A one-way double pole switch with indicator - 2 module	526	10/100
---------	------------------------------------------------------------------	-----	--------

Push buttons 6 A - 250 V AC

6755 04	6 A one-way SP bell push - 1 module	166	20/200
6755 06	6 A one-way SP bell push with indicator - 2 module	328	10/100

Bell call indicator & register - 6 A - 250 V AC

6755 07	Bell call Indicator with register - 6 A - one-way - SP - 1 module	880	20/200
---------	--------------------------------------------------------------------------	-----	--------

Lighting modules

6755 95	Indicator light red - 1 module	202	20/200
6755 96	Indicator light orange - 1 module	202	20/200
6755 97	Skirting light with white LED - 3 module	658	1/5/25
6759 76	Skirting light with white LED - 2 module	444	5/50

Dimmers and fan regulators

6755 35	Rotative dimmer 60 - 250 W for light - 2 module	552	1/10/100
6755 33	Mylic dimmer 400 W for light - 1 module	702	1/5/50
6759 64	Fan regulator 100 W with 360° rotation - 2 module	624	10/100
6755 30	Fan regulator 100 W, Humfree, 0-4 steps - 2 module	672	1/10/100
6755 31	Fan regulator 100 W, Humfree, 0-4 steps - 1 module	504	1/5/50
6759 77	Fan regulator 8 steps - 2 module	672	1/10/100

Mylic™ mechanisms

Cat.Nos	Description	MRP* ₹ / Unit	Pack
---------	-------------	------------------	------

Buzzer

6755 40	Mylic buzzer	590	20/200
---------	--------------	-----	--------

Remote unit

6759 75	Remote control unit with remote for 4 switch & fan load 4 m	3224	1/5/20
---------	-------------------------------------------------------------	------	--------

DND & MMR

Indicator lamp

6755 56	DND & MMR external unit with bellpush 3 m	310	10/50
6759 69	DND & MMR external unit with bellpush 1+1 - 2 m	310	10/100
6755 57	Mylic internal control unit for DND & MMR	258	10/100

Hotel key fob switch

6755 60	Hotel key fob switch - monobloc	2854	1/10
6730 38	Only key fob for 6755 60	174	1/10

Energy sockets / power unit

Energy sockets

6755 50	6 A - 2/3 pin combine - 2 module	186	10/100
6755 55	6/16 A - 3 pin combine - 2 module	306	10/100
6755 51	6 A - 3 pin - 2 module	204	10/100
6755 52	Universal socket 6 A - 2/3 pin combine - 2 module	234	10/100
6755 53	Euro US socket 6/16 A - 2 pin, 1 module	292	20/200
6755 54	6/10/13 A - multistandard socket - 2 Module	308	10/100

Power unit

6755 58	Power unit for 2 ton A.C and 3.5 KW geyser - 4 module	1080	5/25
---------	--------------------------------------------------------------	------	------

Motor starter

6759 65	Motor starter 16 A 2 m	504	1/10/100
---------	------------------------	-----	----------

Modular MCB (IS : 60898-1:2002)

6759 74	Modular SP MCB 16 A 1 m	368	1/10/100
6756 40	Modular SP MCB 20 A 1 m	368	1/10/100
6756 41	Modular SP MCB 25 A 1 m	368	1/10/100
6756 42	Modular SP MCB 32 A 1 m	368	1/10/100

Low voltage sockets / TV socket and RJ11 telephone socket / accessories

6755 46	TV socket 1 module	166	20/200
6755 41	RJ 11 telephone socket 1 module	154	20/200
6755 44	Double RJ 11 telephone socket 1 module	260	20/200
6759 66	RJ45 socket cat 5e with shutter - 1 module	422	20/200
6759 67	RJ45 socket cat 6 with shutter - 1 module	588	20/200

* MRP - Maximum Retail Price Inclusive of all taxes including GST.

Bold Cat.Nos are products normally available with Legrand (India) Stockists. Cat.Nos that are not bold - delivery within 4 - 8 weeks from the date of order. Bold packing quantity is our mandatory packing. Orders to be placed by Legrand (India) Stockist in multiples of the same.

Mylic™ mechanisms

Cat.Nos	Description	MRP* ₹ / Unit	Pack
---------	-------------	------------------	------

USB chargers (IS13252(Part 1) / IEC 60950-1)

6759 71	USB charger - 1 module	862	10/100
6758 20*	USB charger 1M 1500MA	990	10/100
6759 72	Double USB charger - 2 module	1420	10/100

Accessories

6755 91	Cable outlet - 1 module	142	20/200
6755 90	Blanking plate 0.8 mm - 1 module	36	20/200
6755 92	Spare 12 screws with nuts	52	20/200

Mylic™ plates

Modular white plates with frame

6755 61	1 module plate - white	106	20/200
6755 62	2 modules plate - white	106	20/200
6755 63	3 modules plate - white	138	10/100
6755 64	4 modules plate - white	160	10/100
6755 66	6 modules plate - white	200	5/50
6755 67	8 modules horizontal - white	254	5/50
6755 68	4x2 modules plate - white	260	5/25
6755 69	9 modules plate- white	302	5/50
6755 72	12 modules plate - white	372	10
6755 73	16 modules plate - white	430	10
6755 78	18 modules plate - white	576	10

Mylic™ mechanism matt grey

Switches and accessories

Switches 6 A - 250 V AC

6763 01	6 A one-way SP switch - 1 module	106	20/200
6763 02	6 A two-way SP switch - 1 module	174	20/200
6763 03	6 A one-way SP switch with indicator - 1 module	202	20/200

Switches 16 A - 250 V AC

6763 11	16 A one-way SP switch 1 module	194	20/200
6763 12	16 A two-way SP switch 1 module	242	20/200
6763 13	16 A one-way SP switch with indicator 1 module	258	20/200

Switch 25 A - 250V AC

6763 41	Switch 25 A with indicator - 1 module	304	10/100
---------	-------------------------------------------------	-----	---------------

Switches 32 A - 250V AC

6763 26	32 A one-way double pole switch with indicator - 2 module	586	20/200
---------	------------------------------------------------------------------------	-----	---------------

Push buttons 6 A - 250 V AC

6763 04	6 A one-way SP bell push 1 module	176	20/200
6763 06	6 A one-way SP bell push with indicator 2 module	362	10/100

* MRP - Maximum Retail Price Inclusive of all taxes including GST.
* To be Introduced Shortly

Mylic™ mechanism matt grey

Cat.Nos	Description	MRP* ₹ / Unit	Pack
---------	-------------	------------------	------

Bell call indicator & register - 6 A - 250 V AC

6763 07	Bell call indicator with register - 6 A - one way 1 module	970	20/200
---------	-------------------------------------------------------------------------	-----	---------------

Lighting modules

6763 14	Indicator light red 1 module	222	20/200
6763 15	Indicator light orange 1 module	222	20/200
6763 16	Skirting light with white LED - 3 module	724	1/5/25
6763 10	Skirting light with white LED - 2 module	490	5/50

Dimmers and fan regulators

6763 17	Rotative dimmer 60 - 250 W for light 2 module	608	1/10/100
6763 18	Rotative dimmer 60 - 400 W 1 module	774	1/5/50
6763 37	Fan regulator 100 W, with 360° rotation 2 module	686	10/100
6763 19	Fan regulator 4 step 2 module	740	1/10/100
6763 20	Fan regulator 4 step 1 module	552	1/5/50
6763 08	Fan regulator 8 step 2 module	736	1/10/100

Buzzer

6763 21	Mylic buzzer	644	20/200
---------	--------------	-----	---------------

Remote unit

6763 47	Remote control unit with remote for 4 switch & fan load 4 m	3548	1/5/20
---------	-------------------------------------------------------------------	------	--------

DND & MMR

Indicator lamp

6763 42	DND & MMR external unit with bellpush 1+1	342	10/100
6763 23	Mylic internal control unit for DND & MMR	286	10/100

Hotel key fob switch

6730 38	Only key fob for 6755 60	174	1/10
6763 24	Hotel key fob switch monobloc	3136	1/10

Energy sockets / power unit

Energy sockets

6763 25	6 A - 2/3 pin combined	208	10/100
6763 05	6/16A - 3 pin Combined 2 module	330	10/100
6763 27	6 A - 3 pin - 2 module	224	10/100
6763 28	Universal socket 6A-2/3 pin combined 2 module	258	10/100

Bold Cat.Nos are products normally available with Legrand (India) Stockists.
Cat.Nos that are not bold - delivery within 4 - 8 weeks from the date of order.
Bold packing quantity is our mandatory packing. Orders to be placed by
Legrand (India) Stockist in multiples of the same.

Mylic™ mechanism matt grey

Cat.Nos	Description	MRP* ₹ / Unit	Pack
---------	-------------	------------------	------

Energy sockets / power unit

Energy sockets

6763 29	Euro US socket 6/16A - 2 pin 1 module	322	20/200
6763 30	6/10/13 A - Multistandard socket 2 module	334	10/100

Power unit

6763 31	Power unit for 2 ton A.C and 3.5 KW geyser - 4 module	1224	5/25
---------	--------------------------------------------------------------------	------	------

Motor starter

6763 38	Motor starter 16 A 2 m	558	1/10/100
---------	------------------------	-----	----------

Modular MCB (IS : 60898-1:2002)

6763 46	Modular SP MCB 16 A 1 m	412	1/10/100
---------	----------------------------	-----	----------

Low voltage sockets / TV socket and RJ11 telephone socket / accessories

Sockets

6763 32	TV socket - 1 module	176	20/200
6763 33	RJ 11 telephone 1 module	170	20/200
6763 34	Double RJ 11 telephone socket 1 module	282	20/200
6763 39	RJ 45 socket cat 5e with shutter 1 module	458	20/200
6763 40	RJ 45 socket cat 6 with shutter 1 module	640	20/200

USB chargers (IS13252(Part 1) / IEC 60950-1)

6763 43	USB charger 1 module	946	10/100
6758 21*	USB charger 1M 1500MA	1086	10/100
6763 44	Double USB charger 2 module	1564	1/10/100

Accessories

6763 48	Cable outlet 1 module	162	20/200
6763 49	Blanking plate 0.8 mm 1 module	38	20/200

Mylic™ plates

Modular Matt Grey plates with frame

6763 50	Matt grey plate 1 m	136	20/200
6763 51	Matt grey plate 2 m	136	20/200
6763 52	Matt grey plate 3 m	190	10/100
6763 53	Matt grey plate 4 m	202	10/100
6763 54	Matt grey plate 6 m	254	5/50
6763 55	Matt grey plate 8 m horizontal	334	5/50
6763 56	Matt grey plate 4x2 m	334	5/25
6763 57	Matt grey 9 m	392	5/50
6763 58	Matt grey plate 12 m	480	10
6763 59	Matt grey plate 18 m	758	10

Modular colour plates with frame

Cat.Nos	Description	MRP* ₹ / Unit	Pack
---------	-------------	------------------	------

Pearl white cover plates

6763 60	Pearl white plate 1 m	126	10/100
6763 61	Pearl white plate 2 m	126	10/100
6763 62	Pearl white plate 3 m	172	10/100
6763 63	Pearl white plate 4 m	184	10/100
6763 64	Pearl white plate 6 m	240	5/50
6763 65	Pearl white 8 m plate horizontal	306	5/50
6763 66	Pearl white plate 4x2 m	310	5/25
6763 67	Pearl white plate 9 m	362	5/50
6763 68	Pearl white plate 12 m	442	5/25
6763 69	Pearl white plate 18 m	694	5/25

Champagne cover plates

6763 70	Champagne plate 1 m	126	10/100
6763 71	Champagne plate 2 m	126	10/100
6763 72	Champagne plate 3 m	172	10/100
6763 73	Champagne plate 4 m	184	10/100
6763 74	Champagne plate 6 m	240	5/50
6763 75	Champagne plate 8 m horizontal	360	5/50
6763 76	Champagne plate 4x2 m	310	5/25
6763 77	Champagne plate 9 m	362	5/50
6763 78	Champagne plate 12 m	442	5/25
6763 79	Champagne plate 18 m	694	5/25

Silver alu cover plates

6763 80	Silver alu plate 1 m	126	10/100
6763 81	Silver alu plate 2 m	126	10/100
6763 82	Silver alu plate 3 m	172	10/100
6763 83	Silver alu plate 4 m	184	10/100
6763 84	Silver alu plate 6 m	240	5/50
6763 85	Silver alu plate 8 m horizontal	306	5/50
6763 86	Silver alu plate 4x2 m	310	5/25
6763 87	Silver alu plate 9 m	362	5/50
6763 88	Silver alu plate 12 m	442	5/25
6763 89	Silver alu plate 18 m	694	5/25

Dark bronze cover plates











6763 90	Dark bronze plate 1 m	126	10/100
6763 91	Dark bronze plate 2 m	126	10/100
6763 92	Dark bronze plate 3 m	172	10/100
6763 93	Dark bronze plate 4 m	184	10/100
6763 94	Dark bronze plate 6 m	240	5/50
6763 95	Dark bronze plate 8 m horizontal	306	5/50
6763 96	Dark bronze plate 4x2 m	310	5/25
6763 97	Dark bronze plate 9 m	362	5/50
6763 98	Dark bronze plate 12 m	442	5/25
6763 99	Dark bronze plate 18 m	694	5/25

* MRP - Maximum Retail Price Inclusive of all taxes including GST.

* To be Introduced Shortly

Bold Cat.Nos are products normally available with Legrand (India) Stockists. Cat.Nos that are not bold - delivery within 4 - 8 weeks from the date of order. Bold packing quantity is our mandatory packing. Orders to be placed by Legrand (India) Stockist in multiples of the same.

Mylic™ boxes

Cat.Nos	Description	MRP* ₹ / Unit	Pack
Modular white surrounds			
 6755 81	1 module	42	20/200
 6755 82	2 modules	66	20/200
	3 modules	66	10/100
	4 modules	104	10/100
	6 modules	148	10/100
	(2 column x 3)		
 6755 89	9 modules (3 column x 3)	258	10/100
Metal flush boxes			
 6890 07	Flush box - 1/2 modules	108	40
	Flush box - 3 modules	108	40
 6890 08	Flush box - 4 modules	148	40
	Flush box - 6 modules	232	40
 6890 09	Flush box - 8 modules	272	40
	Flush box - 4 x 2 modules	270	20
 6890 09	Flush box - 9 modules	316	20
	Flush box - 12 modules	406	10
 6890 10	Flush box - 16 modules	464	10
	Flush box - 18 modules	514	10
Plastic surface boxes			
 6733 03	Surface box- 1/2 modules	74	10/50
	Surface box- 3 modules	88	5/35
	Surface box- 4 modules	102	5/25
 6733 04	Surface box- 6 modules	130	1/10
	Surface box- 8 modules	196	1/5
	Surface box- 4 x 2 modules	190	1/5
	Surface box- 9 modules	222	1/5
Metal surface boxes			
6890 21	Metal surface box- 12 modules (2 rows x 6)	468	1/6
6890 22	Metal surface box- 18 modules (3 rows x 6)	494	1/4

MYLINC™

A LITTLE TOUCH OF GENIUS

Guarantee

- The Company, at its discretion, will replace products if they have any manufacturing defect within 10 years for switches (without LED lamp) and power sockets. For all other **Mylic™** wiring accessories the guarantee will be 2 years.
- The above guarantee is applicable when the devices are used in Legrand metal flush boxes. Otherwise the guarantee period will be reduced by 50%.
- The guarantee is only applicable when the products are installed as per the Company's instructions and not tampered in any manner.
- The guarantee states the Company's entire liability. It does not extend to cover consequential loss or damage or installation costs arising from defective products.

* MRP - Maximum Retail Price Inclusive of all taxes including GST.

LYNCUS™

TIME TO CHANGE TO TODAY

Today's homes need a range that mirrors their look. A modern sleek look with clean lines. A look that is chic and futuristic. Our new Lyncus range brings the aesthetic to your home, but with a subtle touch that adds character to every room

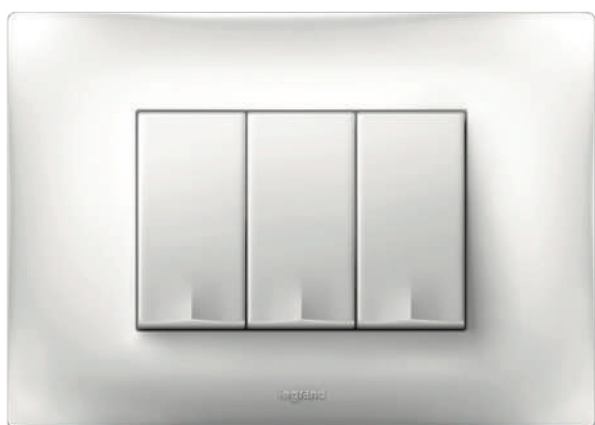

White



Chic Grey

LYNCUS™

TIME TO CHANGE TO TODAY

RANGE



Brushed



Alu Sunset

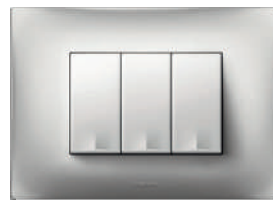

Champagne



Matt Silver



USB TYPE C



USB TYPE A + TYPE C



COMBI TWIN USB



REMOTE CONTROL UNIT



INDUCTION CHARGER



BLUETOOTH SOUND RECEIVER



ONE WAY TOUCH SWITCH



TOUCH FAN REGULATOR



UNIVERSAL TOUCH DIMMER

Lyncus™ mechanisms white

NEW!

Cat.Nos	Description	MRP* ₹ / Unit	Pack
---------	-------------	------------------	------

Switches 6 A 230 V AC

6772 00	6 A Switch 1 W 1 module	80	20/200
6772 01	6 A Switch 2 W 1 module	140	20/200
6772 02	6 A Switch 1 W 1 module with indicator	140	20/200
6772 03	6 A Switch 1 W 1 module with "Light" marking	132	20/200
6772 04	6 A Switch 1 W 1 module with "Fan" marking	132	20/200

Switches 10 A 230 V AC

6772 05	10 A Switch 1 W 2 module	174	10/100
6772 06	10 A Switch 2 W 2 module	202	10/100
6772 07	10 A Intermediate switch 2 module	1150	10/100
6772 08	10 A Switch 1 W with indicator 2 module	222	10/100

Switches 16 A 230 V AC

6772 09	16 A Switch 1 W 1 module	160	20/200
6772 10	16 A Switch 2 W 1 module	198	20/200
6772 11	16 A Switch 1 W with indicator 1 module	208	20/200

Switches 20A 230V AC

6772 12	20 A Switch 1 W 1 module	240	20/200
6772 13	20 A DP Switch 1 W 2 module	346	10/100
6772 14	20 A DP Switch 1 W with indicator 2 module	356	10/100
6772 15	20 A Switch 2 way 2 module	398	10/100

Switches 25 A 230 V AC

6772 16	25 A SP 1 W Switch with indicator 1 module	248	20/200
---------	--------------------------------------------	-----	--------

Switches 32 A 230 V AC

6772 17	32 A DP Switch with indicator 2 module	478	10/100
---------	----------------------------------------	-----	--------

Push button 6 A 230 V AC

6772 18	6 A Push button SP 1 module	114	20/200
6772 19	6 A Push button SP with indicator 1 module	166	20/200
6772 20	6 A Bell push 1 module	148	20/200
6772 21	6 A Bell push with indicator 1 module	180	20/200
6772 22	6 A Bell push 2 module	198	10/100
6772 23	6 A Bell push with indicator 2 module	296	10/100

Accessories for switches

6772 24	LED Indicator for switches	30	5/50
---------	----------------------------	----	------

Socket 240 V AC

6772 25	6/16 A 2 Pin Euro US socket 1 module	256	20/200
6772 26	16 A 3 Pin Switched socket 3 module	508	5/50
6772 27	Multistandard socket 6/10/13 A 2/3 Pin for 250 VAC 15 A for 127 V type 2 Pin 2 module	272	10/100
6772 28	6 A 2/3 Pin Universal socket 2 module	208	20/200
6772 29	6/16 A Socket 3 module	314	5/50
6772 30	6/16 A Socket 2 module	266	10/100
6772 31	6/16 A Euro Socket 2 module	276	10/100
6772 32	25 A Socket 2 module	272	10/100

* MRP - Maximum Retail Price Inclusive of all taxes including GST.
Red Cat.Nos - new products

Lyncus™ mechanisms white

NEW!

Cat.Nos	Description	MRP* ₹ / Unit	Pack
---------	-------------	------------------	------

Dimmers and fan regulators

6772 36	Rotary light dimmer 400 W 1 module	482	5/50
6772 37	Rotary light dimmer 500 W 2 module	612	10/100
6772 39	Fan regulator 100 W 1 module	442	5/50
6772 40	Fan regulator 100 W 360 degree 2 module	544	10/100
6772 41	Fan regulator 120 W 360 degree 2 module	620	10/100
6772 42	Fan step regulator 70 W 2 module	596	1/10/100

Emergency light

6772 43	Removable LED lamp 2 module	2000	1/12
---------	-----------------------------	------	------

Skirting light

6772 48	LED skirting light 3 module	402	5/25
---------	-----------------------------	-----	------

Indicator

6772 87	Indicator unit 1 module with transparent led & colored labels	446	10/100
---------	---------------------------------------------------------------	-----	--------

Bell call indicator

6772 49	Bell call indicator 240 V 1 module	796	20/200
---------	------------------------------------	-----	--------

Buzzer

6772 50	Buzzer 230 V 1 module	532	20/200
---------	-----------------------	-----	--------

Infrared Sensors

6772 51	Infrared sensor 400 W 2 module	1360	1/50
---------	--------------------------------	------	------

Remote unit

6772 52	Remote control unit for light & fan 4 module	2908	1/5/20
6773 03	Remote control hand unit	544	1/5/30

Hospitality function

Hotel keycard switch

6772 53	16 A Key card switch 2 module	2578	1/10
6772 55	Credit card size key fob	88	10/100

Hotel "DND and MMR" functions

6772 56	DND & MMR indicator with bell push 1+1 module	282	10/100
6772 57	Internal control unit for DND & MMR 1+1 module	234	10/100

Shaver socket

6772 58	Shaver socket 120/240 V MonoBlock with plate 2 module	1960	1/16
---------	-------------------------------------------------------	------	------

Sockets and connectors

TV sockets

6772 60	TV Coaxial socket 1 module	150	20/200
---------	----------------------------	-----	--------

Data & voice

6772 62	Telephone socket RJ11 1 module	138	20/200
6772 63	Telephone socket double RJ11 1 module	234	20/200

Bold Cat.Nos are products normally available with Legrand (India) Stockists. Cat.Nos that are not bold - delivery within 4 - 8 weeks from the date of order. Bold packing quantity is our mandatory packing. Orders to be placed by Legrand (India) Stockist in multiples of the same.

Lyncus™ sockets and connectors

NEW!



6772 63



6772 67



6772 70



6772 71



6772 74



6772 88



6772 89



6772 90



6772 92



6772 95



6772 98



6773 04

Data & voice

Cat.Nos	Description	MRP* ₹ / Unit	Pack
6772 64	RJ 45 UTP cat 5 tooless with shutter 1 M white	400	20/200
6772 65	RJ 45 UTP cat 6 tooless with shutter 1 M white	560	20/200

Audio video connectors

Cat.Nos	Description	MRP* ₹ / Unit	Pack
6772 67	Preterminated audio video connector 1 module	1146	1/10
6772 68	Preterminated HDMI socket 1 module	1406	1/10
6772 69	Preterminated projector connector 1 module	1406	1/10

Sound (Volume controller)

Cat.Nos	Description	MRP* ₹ / Unit	Pack
6772 70	Volume controller 2 module	870	1/10/100

Protectors and accessories

Motor starter

Cat.Nos	Description	MRP* ₹ / Unit	Pack
6772 71	16 A Motor starter 2 module	508	1/10/100
6772 72	25 A Motor starter 2 module	508	1/10/100

VSP

Cat.Nos	Description	MRP* ₹ / Unit	Pack
6772 74	Voltage surge protector 230 V 1 module	1602	20/200

Modular MCB (IS : 608981:2002)

Cat.Nos	Description	MRP* ₹ / Unit	Pack
6772 81	16 A MCB SP 1 M C curve	334	1/10/100
6772 82	20 A MCB SP 1 M C curve	334	1/10/100
6772 83	32 A MCB SP 1 M C curve	334	1/10/100

Electronic function

USB chargers (IS13252 (Part 1) / IEC 60950-1)

Cat.Nos	Description	MRP* ₹ / Unit	Pack
6772 88	USB Charger 1000 mA 1 module type A	668	1/5/50
6772 91*	USB Charger 1500 mA 1 module type A	768	1/5/50
6772 89	Double USB charger 3000 mA 2 module type A & type C	2002	1/10/100
6772 90	USB Charger 1500 mA 1 module type C	962	1/5/50

Combi (Socket + USB)

Cat.Nos	Description	MRP* ₹ / Unit	Pack
6772 92	Combi twin USB 2400 mA multistandard socket type A	2310	1/5/50
6772 94	Combi twin USB 2400 mA multistandard socket type A & type C	2542	1/5/50

Wireless charger**

Cat.Nos	Description	MRP* ₹ / Unit	Pack
6772 95	Wireless charger + type-A USB 1 A - 5 V / 5 W charger with one 2.4 A/12 W USB port to power a second device	5704	1/10

Loud speakers

Cat.Nos	Description	MRP* ₹ / Unit	Pack
6772 98	Loudspeaker for false ceiling & plaster board 8 Ohms 10 W	1814	1/6

Sound diffusion

Cat.Nos	Description	MRP* ₹ / Unit	Pack
6772 99*	Bluetooth sound diffusion 2 module	4002	1/10/100

Rotary dimmer universal

Cat.Nos	Description	MRP* ₹ / Unit	Pack
6773 04	Rotary led light dimmer 50 W 1 module	1868	1/10/120

* MRP - Maximum Retail Price Inclusive of all taxes including GST.
* To be Introduced Shortly
** Charging only with wireless compatible phone having induction receiver technology
Red Cat.Nos - new products

Lyncus™ electronic function

NEW!



6773 09



6773 06



6773 15



6773 16



6772 75



6772 76



6774 00



6774 03

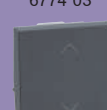

6774 06



6774 10



6774 12



6774 15



6774 17

Cat.Nos	Description	MRP* ₹ / Unit	Pack
---------	-------------	------------------	------

Touch switches

6773 09	6 A Touch switch 1 W 2 module	2758	1/50
6773 10	6 A Touch Switch 2 W 2 Module	3184	1/50
6773 13	16 A Touch switch 1 W 2 module	3184	1/50
6773 06	6 A Touch bell push 2 module	2758	1/50

Touch regulator & dimmer

6773 05	Touch fan regulator 100 W 2 module	3184	1/50
6773 15	300 W Universal led touch light scroll dimming 2 module	3184	1/50

Reading light

6773 16	Reading light led	1556	1/12
---------	-------------------	------	------

Accessories

6772 75	Cable outlet 8 mm 1 module	128	20/200
6772 76	Blanking plate 1 module	32	20/200
6772 77	Blanking plate 2 module	46	10/100

Lyncus™ mechanisms chic grey

Switches 6A 230V AC

6774 00	6 A Switch 1 W 1 module	90	20/200
6774 01	6 A Switch 2 W 1 module	162	20/200
6774 02	6 A Switch 1 W 1 module with Indicator	166	20/200
6774 03	6 A Switch 1 W 1 module with "Light" marking	156	20/200
6774 04	6 A Switch 1 W 1 module with "Fan" marking	156	20/200

Switches 10A 230V AC

6774 05	10 A Switch 1 W 2 module	198	10/100
6774 06	10 A Switch 2 W 2 module	234	10/100
6774 07	10 A Intermediate switch 2 module	1234	10/100
6774 08	10 A Switch 1 W with Indicator 2 module	256	10/100

Switches 16A 230V AC

6774 09	16 A Switch 1 W 1 module	182	10/100
6774 10	16 A Switch 2 W 1 module	230	20/200
6774 11	16 A Switch 1 W with indicator 1 module	240	20/200

Switches 20A 230V AC

6774 12	20 A Switch 1 W 1 module	276	20/200
6774 13	20 A DP Switch 1 W 2 module	402	10/100
6774 14	20 A DP Switch 1 W with indicator 2 module	408	10/100
6774 15	20 A Switch 2 W 2 module	458	10/100

Switches 25A 230V AC

6774 16	25A SP 1 W Switch with indicator 1 module	286	20/200
---------	-------------------------------------------	-----	--------

Switches 32A 230V AC

6774 17	32A DP Switch with indicator 2 module	546	10/100
---------	---------------------------------------	-----	--------

Bold Cat.Nos are products normally available with Legrand (India) Stockists. Cat.Nos that are not bold - delivery within 4 - 8 weeks from the date of order. Bold packing quantity is our mandatory packing. Orders to be placed by Legrand (India) Stockist in multiples of the same.

Lyncus™ mechanisms chic grey

NEW!



6774 18



6774 22



6774 27



6774 29



6774 31



6774 37



6774 39



6774 48



6774 49



6774 50



6774 56

Cat.Nos	Description	MRP* ₹ / Unit	Pack
---------	-------------	------------------	------

Push button 6 A 230 V AC

6774 18	6 A Push button SP 1 module	132	20/200
6774 19	6 A Push button SP with indicator 1 module	188	20/200
6774 20	6 A Bell push 1 module	170	20/200
6774 21	6 A Bell push with indicator module	202	20/200
6774 22	6 A Bell push 2 module	228	10/100
6774 23	6 A Bell Push with indicator 2 module	340	10/100

Sockets 240 V AC

6774 25	6/16 A 2 Pin Euro US socket 1 module	294	20/200
6774 27	Multistandard socket 6/10/13 A 2/3 Pin for 250 VAC 15 A for 127 V type 2 Pin 2 module	308	10/100
6774 28	6 A 2/3 Pin Universal socket 2 module		20/200
6774 29	6/16 A Socket 3 module	236	5/50
6774 30	6/16 A Socket 2 module	360	10/100
6774 31	6/16 A Euro socket 2 module	306	10/100
6774 32	25 A Socket 2 module	312	10/100

Dimmers and fan regulators

6774 36	Rotary light dimmer 400 W 1 module	552	5/50
6774 37	Rotary light dimmer 500 W 2 module	710	10/100
6774 39	Fan regulator 100 W 1 module	510	5/50
6774 40	Fan regulator 100 W 360 degree 2 module	626	10/100
6774 41	Fan regulator 120 W 360 degree 2 module	714	10/100
6774 42	Fan step regulator 70 W 2 module	690	1/10/100

Skirting light

6774 48	LED skirting light 3 module	462	5/25
---------	-----------------------------	-----	------

Bell call indicator

6774 49	Bell call indicator 240 V 1 module	912	20/200
---------	------------------------------------	-----	--------

Buzzer

6774 50	Buzzer 230 V 1 module	612	20/200
---------	-----------------------	-----	--------

Remote unit

6774 52	Remote control unit for light & fan 4 module	3344	1/5/20
6773 03	Remote control hand unit	544	1/5/30

Hospitality function

Hotel keycard switch

6774 53	16A Key card switch 2 module credit card size key fob	2964	1/10
---------	-------------------------------------------------------	------	------

Hotel "DND and MMR" functions

6774 56	DND & MMR indicator with bell push 1+1 module	324	10/100
6774 57	Internal control unit for DND & MMR 1+1 module	268	10/100

Lyncus™ hospitality function

NEW!



6774 58



6774 60



6774 62



6774 64



6774 70



6774 88

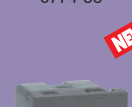

6774 89



6774 92



6774 94



6774 99



6774 76



6775 02

Cat.Nos	Description	MRP* ₹ / Unit	Pack
---------	-------------	------------------	------

Shaver socket

6774 58	Shaver socket 120/240 V MonoBlock with plate 2 module	2254	1/16
---------	-------------------------------------------------------	------	------

Sockets and connectors

TV sockets

6774 60	TV Coaxial socket 1 module	168	20/200
---------	----------------------------	-----	--------

Data & voice

6774 62	Telephone socket RJ11 1 module	160	20/200
6774 63	Telephone socket double RJ11 1 module	272	20/200
6774 64	RJ 45 UTP cat 5 tooless with shutter 1 M grey	440	20/200
6774 65	RJ 45 UTP cat 6 tooless with shutter 1 M grey	616	20/200

Audio video sockets

6774 67	Preterminated audio video connector 1 module	1320	1/10
6774 68	Preterminated HDMI socket 1 module	1614	1/10
6774 69	Preterminated projector connector 1 module	1614	1/10

Sound (Volume controller)

6774 70	Volume controller 2 module	1000	1/10/100
---------	----------------------------	------	----------

Electronic function

USB chargers (IS13252 (Part 1) / IEC 609501)

6774 88	USB charger 1000 mA 1 module type A	768	1/5/50
6774 91*	USB charger 1500 mA 1 module type A	884	1/5/50
6774 89	Double USB charger 3000 mA 2 module type A & type C	2302	1/10/100
6774 90	USB charger 1500 mA 1 module type C	1108	1/5/50

Combi (Socket+USB)

6774 92	Combi twin USB 2400 mA multi-standard socket type A	2654	1/5/50
6774 94	Combi twin USB 2400 mA multi-standard socket type A & type C	2924	1/5/50

Sound receiver

6774 99*	Bluetooth sound diffusion 2 module	4600	1/10/100
----------	------------------------------------	------	----------

Rotary dimmer universal

6774 24	Rotary led dimmer 50 W 1 module	2254	1/10/120
---------	---------------------------------	------	----------

Accessories

6774 75	Cable outlet 8 mm 1 module	154	20/200
6774 76	Blanking plate 1 module	36	20/200

Lyncus plate frame white

6775 01	Classic white plate + Frame 1 M	98	20/200
6775 02	Classic white plate + Frame 2 M	98	20/200
6775 03	Classic white plate + Frame 3 M	128	10/100

* MRP - Maximum Retail Price Inclusive of all taxes including GST.

Red Cat.Nos - new products

To be Introduced Shortly

Bold Cat.Nos are products normally available with Legrand (India) Stockists. Cat.Nos that are not bold - delivery within 4 - 8 weeks from the date of order. Bold packing quantity is our mandatory packing. Orders to be placed by Legrand (India) Stockist in multiples of the same.

Lyncus™ plate frame

NEW!

Cat.Nos	Description	MRP* ₹ / Unit	Pack
---------	-------------	------------------	------

Lyncus plate frame white

6775 04	Classic white plate + Frame 4 M	140	10/100
6775 06	Classic white plate + Frame 6 M	176	5/50
6775 08	Classic white plate + Frame 8 M (H)	228	5/50
6775 09	Classic white plate + Frame 2 x 4 M	236	5/25
6775 12	Classic white plate + Frame 12 M	326	10
6775 16	Classic white plate + Frame 16 M	380	10
6775 18	Classic white plate + Frame 18 M	512	10

Plate frame chic grey

6775 21	Chic grey plate+Frame 1 M	124	20/200
6775 22	Chic grey plate+Frame 2 M	124	20/200
6775 23	Chic grey plate+Frame 3 M	170	10/100
6775 24	Chic grey plate+Frame 4 M	178	10/100
6775 26	Chic grey plate+Frame 6 M	228	5/50
6775 28	Chic grey plate + Frame 8 M (H)	302	5/50
6775 29	Chic grey plate + Frame 2x4 M	302	5/25
6775 32	Chic grey plate + Frame 12 M	426	10
6775 36	Chic grey plate + Frame 16 M	488	10
6775 38	Chic grey plate + Frame 18 M	670	10

Plate frame brushed

6775 41	Brushed silver plate + Frame 1 M	130	20/200
6775 42	Brushed silver plate + Frame 2 M	130	20/200
6775 43	Brushed silver plate + Frame 3 M	178	10/100
6775 44	Brushed silver plate + Frame 4 M	186	10/100
6775 46	Brushed silver plate + Frame 6 M	242	5/50
6775 48	Brushed silver plate + Frame 8 M (H)	314	5/50
6775 49	Brushed silver plate + Frame 2x4 M	314	5/25
6775 52	Brushed silver plate + Frame 12 M	448	10
6775 56	Brushed silver plate + Frame 16 M	516	10
6775 58	Brushed silver plate + Frame 18 M	702	10

Plate frame alu sun set

6775 61	Alu sun set plate + Frame 1 M	128	20/200
6775 62	Alu sun set plate + Frame 2 M	128	20/200
6775 63	Alu sun set plate + Frame 3 M	170	10/100
6775 64	Alu sun set plate + Frame 4 M	184	10/100
6775 66	Alu sun set plate + Frame 6 M	236	5/50
6775 68	Alu sun set plate + Frame 8 M	302	5/50
6775 69	Alu sun set plate + Frame 2x4 M	306	5/25
6775 72	Alu sun set plate + Frame 12 M	438	10
6775 76	Alu sun set plate + Frame 16 M	500	10
6775 78	Alu sun set plate + Frame 18 M	686	10

Lyncus™

NEW!

Cat.Nos	Description	MRP* ₹ / Unit	Pack
---------	-------------	------------------	------

Plate frame champagne

6775 81	Champagne plate + Frame 1 M	128	20/200
6775 82	Champagne plate + Frame 2 M	128	20/200
6775 83	Champagne plate + Frame 3 M	170	10/100
6775 84	Champagne plate + Frame 4 M	184	10/100
6775 86	Champagne plate + Frame 6 M	236	5/50
6775 88	Champagne plate + Frame 8 M (H)	302	5/50
6775 89	Champagne plate + Frame 2x4 M	306	5/25
6775 92	Champagne plate + Frame 12 M	438	10
6775 96	Champagne plate + Frame 16 M	500	10
6775 98	Champagne plate + Frame 18 M	686	10

Plate frame matt silver

6776 01	Matt silver plate + Frame 1 M	128	20/200
6776 02	Matt silver plate + Frame 2 M	128	20/200
6776 03	Matt silver plate + Frame 3 M	170	10/100
6776 04	Matt silver plate + Frame 4 M	184	10/100
6776 06	Matt silver plate + Frame 6 M	236	5/50
6776 08	Matt silver plate + Frame 8 M (H)	302	5/50
6776 09	Matt silver plate + Frame 2x4 M	306	5/25
6776 12	Matt silver plate + Frame 12 M	438	10
6776 16	Matt silver plate + Frame 16 M	500	10
6776 18	Matt silver plate + Frame 18 M	686	10

Mounting boxes

Metal flush boxes

6890 07	Flush box - 1/2 module	108	40
6890 08	Flush box - 3 module	108	40
6890 09	Flush box - 4 module	148	40
6890 10	Flush box - 6 module	232	40
6890 42	Flush box - 8 module	272	40
6890 31	Flush box - 8 module (2 row x 4)	270	20
6890 11	Flush box - 12/16 (2 row x 6) module	406	10
6890 12	Flush box - 18 module	514	10

Plastic surface boxes

6733 02	Surface box 1/2 module	74	10/50
6733 03	Surface box 3 module	88	5/35
6733 04	Surface box 4 module	102	5/25
6733 06	Surface box 6 module	130	1/10
6733 08	Surface box 8 module	196	1/5
6733 05	Surface box 8 (2 row x 4) module	190	1/5

Metal surface boxes

6890 21	Surface box 12/16 (2 row x 6) module	468	1/6
6890 22	Surface box 18 module	494	1/4

* MRP - Maximum Retail Price Inclusive of all taxes including GST.
To be Introduced Shortly
Red Cat.Nos - new products

Bold Cat.Nos are products normally available with Legrand (India) Stockists.
Cat.Nos that are not bold - delivery within 4 - 8 weeks from the date of order.
Bold packing quantity is our mandatory packing. Orders to be placed by Legrand (India) Stockist in multiples of the same.

BritzyTM SWITCHES

RANGE



Switch 6 A, 16 A



Switch 6 A two-way



Switch with indicator
6 A, 16 A, 25 A



Bell push with
indicator - 1 module



DP Switch 20 A, 32 A

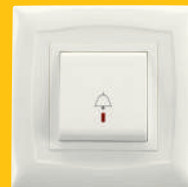

Bell push with
indicator - 2 module



DND internal unit



DND external unit



Universal socket
6 A - 3 pin

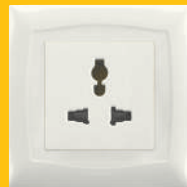

Multi-standard socket



6/16 A socket



Euro US socket



Dimmer



Fan regulator
1 module



Fan regulator
2 module



USB charger
1 module



USB charger
2 module



RJ 45



RJ 11 Telephone socket



Double RJ 11
Telephone socket



Bell call indicator



TV socket

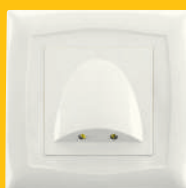

Skirting light



Buzzer



Key card Switch 16 A



Flat indicator red

Britzy™ switches

Cat.Nos	Description	MRP* ₹ / Unit	Pack
---------	-------------	------------------	------

Switches

- All switches are ISI marked as per latest IS 3854:1997
- Finger-proof terminal for protection against accidental contact
- Laser marking for easy identification

6734 01	6 A Switch SP 1 way 1 module	42	20/200
6734 02	6 A Switch SP 2 way 1 module	88	20/200
6734 03	6 A Switch SP 1 way with indicator 1 module	88	20/200
6734 11	16 A Switch SP 1 way 1 module	126	20/200
6734 12	16 A Switch SP 2 way 1 module	152	20/200
6734 13	16 A Switch SP 1 way with indicator 1 module	136	20/200
6734 24	25 A Switch SP 1 way with indicator 1 module	174	20/200
6734 25	20 A DP switch with indicator 2 modules	194	10/100
6734 26	32 A DP switch with indicator 2 modules	260	10/100

Push buttons

6734 04	6 A Bell push with indicator module 1	102	20/200
6734 06	6 A Bell push with indicator 2 module	158	10/100

Sockets

- Confirming to IS 1293:2005
- Shuttered socket for child safety
- Shutter open only with phase and neutral insertion simultaneously

6734 52	6 A 3 pin universal socket 2 modules	104	10/100
6734 53	Euro US socket 1 module	88	20/200
6734 55	6/16 A socket 3 Pin 2 modules	172	10/100
6734 56	25 A socket 3 Pin 2 modules	194	10/100
6734 54	Multistandard socket 2 modules	154	10/100

Data & voice

6734 41	RJ11 telephone socket 1 module	88	20/200
6734 44	Double RJ11 telephone socket 1 module	128	20/200
6734 45	RJ45 Cat 6 computer socket 1 module	256	20/200

- * MRP - Maximum Retail Price Inclusive of all taxes including GST.
- To be Introduced Shortly



Britzy™ switches

Cat.Nos	Description	MRP* ₹ / Unit	Pack
---------	-------------	------------------	------

Television socket

6734 46	TV socket 1 module	82	20/200
----------------	---------------------------	----	--------

Buzzer

6734 40	Buzzer 230 V 1 module	272	20/200
---------	---------------------------------	-----	--------

Dimmer & regulator

6734 31	Fan regulator 100 W 1 module	370	5/50
6734 30	Fan regulator 100 W 2 modules	466	10/100
6734 33	Light dimmer 400 W 1 module	378	5/50

Bell indicator

6734 07	Bell call indicator 1 module	516	20/200
---------	------------------------------	-----	--------

Motor starter

6734 66	25 A Motor starter 2 modules	428	10/100
---------	----------------------------------------	-----	--------

Modular MCB (IS : 60898-1:2002)

6734 64	Modular SP MCB 16A	304	1/10/100
6734 61	Modular SP MCB 20A	304	1/10/100
6734 36	Modular SP MCB 25A	304	1/10/100
6734 37	Modular SP MCB 32A	304	1/10/100

USB Charger

6734 34	USB charger 1M 1000mA	630	10/100
6731 35*	USB charger 1M 1500mA	774	10/100
6734 35	Double USB charger 2M 2000mA	1062	5/50

Skirting light

6734 77	Skirting light 2 modules	360	5/50
---------	---------------------------------	-----	------

Indicator

6734 75	Flat indicator red 1 module	94	20/200
----------------	------------------------------------	----	--------

Key card switch

6734 80	16 A Key card switch 2 modules	1946	1/10
6734 83	Keyfob credit card size for 6734 80	144	1/10

Do Not Disturb indicator & internal control unit

6734 81	DND internal unit 2 modules	172	10/100
6734 82	DND external unit 2 modules	204	10/100

Accessories

6734 71	Cable outlet 1 module	72	20/200
6734 90	Blanking plate 1 module	26	20/200
6734 72	Blanking plate 2 modules	36	10/100



- Bold Cat.Nos are products normally available with Legrand (India) Stockists.
- Cat.Nos that are not bold - delivery within 4 - 8 weeks from the date of order.
- Bold packing quantity is our mandatory packing. Orders to be placed by Legrand (India) Stockist in multiples of the same.

Britzy™ switches

Cat.Nos	Description	MRP* ₹ / Unit	Pack
---------	-------------	------------------	------

White plates with frame

Sleek and curvy plates with elegant looks comes with sturdy support frame for solid strength

6734 91	Plate & frame 86 x 86 1 module	66	20/200
6734 92	Plate & frame 86 x 86 2 modules	66	20/200
6734 93	Plate & frame 121 x 86 3 modules	90	10/100
6734 94	Plate & frame 146 x 86 4 modules	96	10/100
6734 96	Plate & frame 224 x 86 6 modules	126	5/50
6734 98	Plate & frame 245 x 86 8 modules	162	5/50
6734 95	Plate & frame 146 x 172 4 x 2 modules	162	5/25
6734 97	Plate & frame 224 x 172 12 modules	234	10
6734 99	Plate & frame 245 x 172 16 modules	254	10
6735 00	Plate & frame 224 x 240 18 modules	312	10

WARM ORANGE SILVER plates with frame

6735 01	Plate & frame 86 x 86 1 module	106	20/200
6735 02	Plate & frame 86 x 86 2 modules	106	20/200
6735 03	Plate & frame 121 x 86 3 modules	134	10/100
6735 04	Plate & frame 146 x 86 4 modules	160	10/100
6735 05	Plate & frame 224 x 86 6 modules	226	5/50
6735 06	Plate & frame 245 x 86 8 modules	240	5/50
6735 07	Plate & frame 146 x 172 4 x 2 modules	294	5/25
6735 08	Plate & frame 224 x 172 12 modules	408	10
6735 09	Plate & frame 245 x 172 16 modules	548	10
6735 10	Plate & frame 224 x 240 18 modules	632	10

HERB BEIGE plates with frame

6735 11	Plate & frame 86 x 86 1 module	106	20/200
6735 12	Plate & frame 86 x 86 2 modules	106	20/200
6735 13	Plate & frame 121 x 86 3 modules	134	10/100
6735 14	Plate & frame 146 x 86 4 modules	160	10/100
6735 15	Plate & frame 224 x 86 6 modules	226	5/50
6735 16	Plate & frame 245 x 86 8 modules	240	5/50

* MRP - Maximum Retail Price Inclusive of all taxes including GST.
To be Introduced Shortly

Britzy™ switches

Cat.Nos	Description	MRP* ₹ / Unit	Pack
---------	-------------	------------------	------

NEW! HERB BEIGE plates with frame

6735 17	Plate & frame 146 x 172 4 x 2 modules	294	5/25
6735 18	Plate & frame 224 x 172 12 modules	408	10
6735 19	Plate & frame 245 x 172 16 modules	548	10
6735 20	Plate & frame 224 x 240 18 modules	632	10

NEW! URBAN BRONZE plates with frame

6735 21	Plate & frame 86 x 86 1 module	106	20/200
6735 22	Plate & frame 86 x 86 2 modules	106	20/200
6735 23	Plate & frame 121 x 86 3 modules	134	10/100
6735 24	Plate & frame 146 x 86 4 modules	160	10/100
6735 25	Plate & frame 224 x 86 6 modules	226	5/50
6735 26	Plate & frame 245 x 86 8 modules	240	5/50
6735 27	Plate & frame 146 x 172 4 x 2 modules	294	5/25
6735 28	Plate & frame 224 x 172 12 modules	408	10
6735 29	Plate & frame 245 x 172 16 modules	548	10
6735 30	Plate & frame 224 x 240 18 modules	632	10

NEW! ORANGE CHROME plates with frame

6735 31#	Plate & frame 86 x 86 1 module	106	20/200
6735 32#	Plate & frame 86 x 86 2 modules	106	20/200
6735 33#	Plate & frame 121 x 86 3 modules	134	10/100
6735 34#	Plate & frame 146 x 86 4 modules	160	10/100
6735 35#	Plate & frame 224 x 86 6 modules	226	5/50
6735 36#	Plate & frame 245 x 86 8 modules	240	5/50
6735 37#	Plate & frame 146 x 172 4 x 2 modules	294	5/25
6735 38#	Plate & frame 224 x 172 12 modules	408	10
6735 39#	Plate & frame 245 x 172 16 modules	548	10
6735 40#	Plate & frame 224 x 240 18 modules	632	10

Bold Cat.Nos are products normally available with Legrand (India) Stockists. Cat.Nos that are not bold - delivery within 4 - 8 weeks from the date of order. Bold packing quantity is our mandatory packing. Orders to be placed by Legrand (India) Stockist in multiples of the same.

Britzy™ switches

Cat.Nos	Description	MRP* ₹ / Unit	Pack
---------	-------------	---------------------	------

Flush mounting boxes - Metal

- Boxes are with top, bottom, side and back wall knockout for conduit entry from any direction
- Possible to break open knockout without any special tool



6890 60

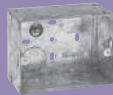

6890 61



6890 63

6890 60	Metal flush box 75.7 x 75.7 x 50.8 1 & 2 modules	58	40
6890 61	Metal flush box 98.9 x 75.7 x 50.8 3 modules	76	40
6890 62	Metal flush box 136 x 75.7 x 50.8 4 modules	96	40
6890 63	Metal flush box 213.4 x 75.7 x 50.8 6 modules	144	40
6890 64	Metal flush box 136.6 x 136.8 x 61 8 (2 rows x 4) modules	186	20
6890 65	Metal flush box 231.2 x 75.7 x 50.8 8 modules	186	40
6890 66	Metal flush box 215 x 145.3 x 61.2 12 (2 rows x 6) modules	258	10
6890 67	Metal flush box 232.8 x 147.4 x 61.2 16 (2 rows x 8) modules	288	10
6890 68	Metal flush box 215 x 213.3 x 61.2 18 modules	332	10

Surface mounting boxes - Plastic

6890 70	Plastic surface box 86 x 86 x 45 1 & 2 modules	52	10/50
6890 71	Plastic surface box 121 x 86 x 45 3 modules	66	5/35
6890 72	Plastic surface box 146 x 86 x 45 4 modules	84	5/25
6890 73	Plastic surface box 224 x 86 x 45 6 modules	128	1/10
6890 74	Plastic surface box 146 x 172 x 45 8 (2 rows x 4) modules	180	2/10
6890 75	Plastic surface box 245.2 x 86 x 45 8 modules	180	1/10
6890 76	Plastic surface box 224 x 172 x 45 12 (2 rows x 6) modules	218	1/10
6890 77	Plastic surface box 245.2 x 172 x 45 16 (2 rows x 8) modules	252	1/10

Surface mounting boxes - Metal

6890 78	Metal surface box 18 modules	268	1/10
---------	----------------------------------------	-----	------

- * MRP - Maximum Retail Price Inclusive of all taxes including GST.
- To be Introduced Shortly

Britzy™

THE NO PROBLEM SWITCH

Guarantee

- The Company, at its discretion, will replace products if they have any manufacturing defect within 10 years for switches (without LED lamp) and power sockets. For all other **Britzy™** wiring accessories the guarantee will be 2 years.
- The above guarantee is applicable when the devices are used in Legrand metal flush boxes. Otherwise the guarantee period will be reduced by 50%.
- The guarantee is only applicable when the products are installed as per the Company's instructions and not tampered in any manner.
- The guarantee states the Company's entire liability. It does not extend to cover consequential loss or damage or installation costs arising from defective products.

WORKSTATION SOLUTIONS

POWER AND DATA DISTRIBUTION FOR THE OFFICE ENVIRONMENT

In order to guarantee convenience and performance for users in office buildings, workstations & different areas must be fitted with solutions that can be fully adjusted to different building infrastructures and still meet the user's connectivity and mobility needs.

These ranges of products are solutions for supplying and fitting out workstations in any kind of building infrastructure: Raised Floor, Flush Floor, Screed Floor & False Ceiling & Wall.



Pop-up boxes - for floor

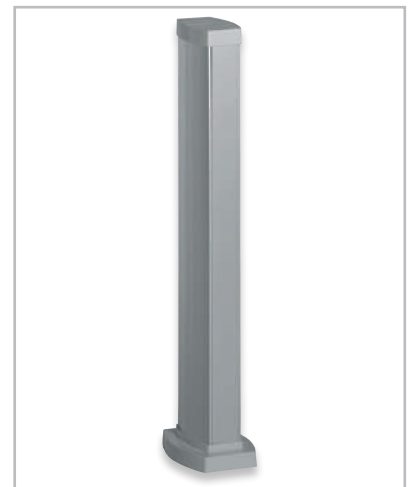

Snap-On mini-columns

LEGRAND'S SOLUTION FOR DISTRIBUTING POWER AND DATA TO WORKSTATIONS

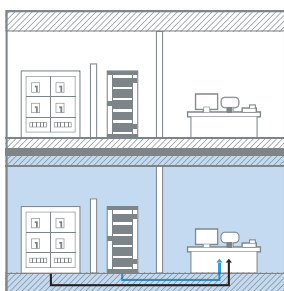

Work station solution supplied through the floor

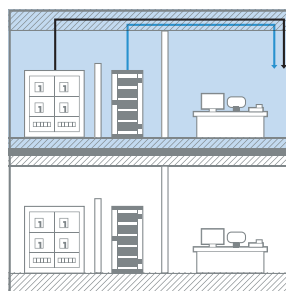

Work station solution supplied through the false ceiling & the wall

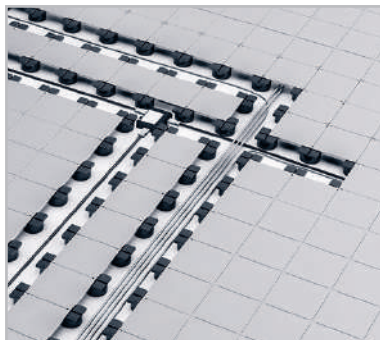

Soluflex cable floor system

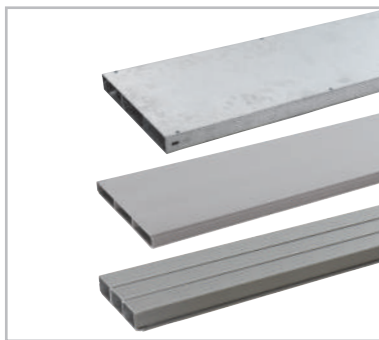

Raceways : PVC & Metal (GI)

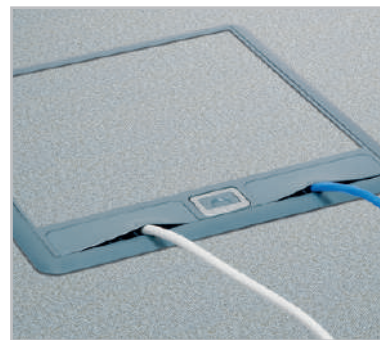

Floor boxes



Raceways : PVC & Metal (GI)



Power & data desk grommets



Dlp trunking system:
Snap-on, Mini & PVC, Aluminium



Cablofil wire mesh cable trays



Cable worm



Flush mounting power & data module

POWER AND DATA DISTRIBUTION & CONNECTION SOLUTIONS

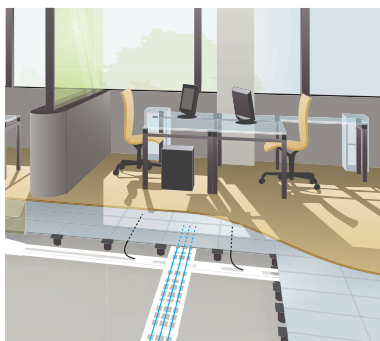

Raised access floor systems



Screed floor system



Wall and ceiling systems

Raceways and junction boxes for screed floors



Cat.Nos	Description	MRP* ₹ / Unit	Pack
---------	-------------	------------------	------

Confirms to EN 50 085 - 2 - 2
Raceways are made from PVC and Galvanised sheet.
Compatible with Cat.6 structured cabling system.

Raceways - PVC

**Raceways - PVC - height 38 mm;
Standard length 2 meters⁽¹⁾; Price per meter**

0896 67	50 mm x 38 mm - 1 compartment	980	12
0896 68	100 mm x 38 mm - 2 compartments	1836	16
0896 69	150 mm x 38 mm - 3 compartments	2756	10

Raceways - Metal / GI

**Raceways - Metal/GI - height 25 mm; length 2.44 m.
Price per unit (One unit is of 2.44 meters)**

6895 10	50 mm x 25 mm - 1 compartment	1708	3/54 ⁽¹⁾
6895 11	75 mm x 25 mm - 1 compartment	2202	3/21 ⁽¹⁾
6895 12	100 mm x 25 mm - 1 compartment	2674	3/54 ⁽¹⁾
6895 13	150 mm x 25 mm - 1 compartment	3702	3/18 ⁽¹⁾
6895 14	225 mm x 25 mm - 3 compartments	5802	3/12 ⁽¹⁾
6895 15	300 mm x 25 mm - 3 compartments	7186	3/18 ⁽¹⁾

**Raceways - Metal/GI - height 38 mm; length 2.44 m
Price per unit (One unit is of 2.44 meters)**

6895 00	50 mm x 38 mm - 1 compartment	1984	3/54 ⁽¹⁾
6895 01	75 mm x 38 mm - 1 compartment	2622	3/21 ⁽¹⁾
6895 02	100 mm x 38 mm - 1 compartment	3174	3/54 ⁽¹⁾
6895 03	150 mm x 38 mm - 1 compartment	4256	3/36 ⁽¹⁾
6895 04	225 mm x 38 mm - 3 compartments	6440	3/12 ⁽¹⁾
6895 05	300 mm x 38 mm - 3 compartments	7890	3/18 ⁽¹⁾

Raceways accessories

Fixing bracket (GI)

For fixing raceways (PVC & Metal) on the floor

6897 09	50 mm x 25 mm (metal)	28	9
6897 10	75 mm x 25 mm (PVC and metal)	46	9
6897 12	100 mm x 25 mm (metal)	52	9
6897 15	150 mm x 25 mm (metal)	68	9
6897 20	225 mm x 25 mm (metal)	94	9
6897 30	300 mm x 25 mm (metal)	126	9

Fixing bracket

6897 27	50 mm x 38 mm (PVC and metal)	30	9
6897 28	75 mm x 38 mm (metal)	52	9
6897 37	100 mm x 38 mm (PVC and metal)	62	9
6897 38	150 mm x 38 mm (PVC and metal)	76	9
6897 25	225 mm x 38 mm (metal)	118	9
6897 35	300 mm x 38 mm (metal)	148	9

Riser

6897 23	Vertical - for 225 mm width raceways	2062	1
6897 33	Vertical - for 300 mm width raceways	2374	1

* MRP - Maximum Retail Price Inclusive of all taxes including GST.
(1) Unit of measure in Nos
¹To be ordered in multiples of 2 meters

Raceways and junction boxes for screed floors



Cat.Nos	Description	MRP* ₹ / Unit	Pack
---------	-------------	------------------	------

Coupler for joining raceways

6897 77	Coupling 38	124	6
6897 79	Coupling 25	92	6

Junction box

For direct access to cables at the intersection of raceways
Supplied completely with base and cover plate (Lid)

Height adjustable junction box 65 - 90 mm

6896 10	150 x 150 x 65 - 90 mm	2288	1
6896 11	225 x 225 x 65 - 90 mm	2834	1
6896 12	300 x 300 x 65 - 90 mm	3736	1
6896 13	400 x 400 x 65 - 90 mm	5652	1

Height adjustable junction box 65 - 90 mm with fly over

For direct access to cables at the intersection of floor raceways while maintaining perfect separation and 900 cross overs between data and power cables

6896 14	225 x 225 x 65 - 90 mm with flyover	3132	1
6896 15	300 x 300 x 65 - 90 mm with flyover	4170	1
6896 16	400 x 400 x 65 - 90 mm with flyover	6254	1

Optional site cover for junction box

6896 18	150 x 150 x 65 - 90 mm with metal cover	258	10
6896 19	225 x 225 x 65 - 90 mm with metal cover	366	10
6896 20	300 x 300 x 65 - 90 mm with metal cover	554	10
6896 21	400 x 400 x 65 - 90 mm with metal cover	842	10

Height adjustable junction box 50 - 70 mm

6896 22	150 x 150 x 50-70 mm	2126	1
6896 23	225 x 225 x 50-70 mm	2612	1
6896 24	300 x 300 x 50-70 mm	3442	1
6896 25	400 x 400 x 50-70 mm	5160	1

Floor boxes for carpet for raised floor, screed floor

Floor boxes for raised floor

6896 38	Full backbox for raised floor - 3 compartments (264x264 mm) height 86 mm	3630	1
6896 31	Lid & trim Grey cover RAL 7031 for 3 compartment floor box with flexible cable exits Size 265 mm x 265 mm	2738	5

Support plates for floor boxes 77 mm width plate

6896 62	Blank plates for floor box	306	12
6896 17	Flat support plate 8 module for integration of Myrius mechanisms	306	1
6896 78	Waved support plates. For 4 modules (2 x 2 modules)	928	4

Bold Cat.Nos are products normally available with Legrand (India) Stockists. Cat.Nos that are not bold - delivery within 4 - 8 weeks from the date of order. Bold packing quantity is our mandatory packing. Orders to be placed by Legrand (India) Stockist in multiples of the same.

Floor boxes for carpet for raised floor, screed floor

Cat.Nos	Description	MRP* ₹ / Unit	Pack
---------	-------------	------------------	------

Floor boxes for screed floor (3 Compartment)

6896 34*	Full backbox for screed floor 3 compartments (for ducting upto 225 mm). Height adjustable to screed height 65 to 90 mm	5624	1
6896 31*	Lid & trim Grey cover RAL 7031 for 3 compartment floor box with flexible cable exits. Size 265 mm x 265 mm	2738	5



6896 34 +
6896 31

Support plates for floor boxes 77 mm width plate

6896 62	Blank plates for floor box	306	12
6896 17	Flat support plate 8 module for integration of Myrius mechanisms	306	1
6896 78	Waved support plates for 4 modules (2x2 modules)	928	4

Floor boxes for screed floor (4 Compartment)

6896 45	Full backbox for screed floor - 4 compartments (for ducting upto 300 mm) Height adjustable to screed height 65 to 90 mm. To be used with 6896 45	6256	1
6896 41	Lid & trim Grey cover RAL 1019 for 4 compartment floor box with flexible cable exits. To be used with 6896 41	3006	5

Support plates for floor boxes

77 mm width plate

6896 62	Blank plates for floor box	306	12
6896 17	Flat support plate 8 module for integration of Myrius	306	1
6896 78	Waved support plates For 4 Modules (2x2 Modules) mechanisms	928	4

Stainless steel insert for Lid

For a metal finish on lid
To be used instead of fitting carpet onto the Lid

6896 92	For 3 compartment floor boxes dimension : 245.5x210 mm	3384	1
---------	-----------------------------------------------------------	------	---

Floor boxes for tile / marble

for screed floor

0896 04	Backbox for screed floor; Screed thickness 65 to 90 mm	4854	1
6896 52	Lid & trim for tiles / marble 15 to 22 mm thickness Stainless steel material AISI 304. 2 cable outlet	23576	1
6896 55	Lid & Trim for tile 8-15 mm thickness Material for head band & single cable outlet - galvanised steel + paint RAL 7031	6464	1



0896 04 +
6896 52

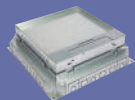

0896 04 +
6896 55

* MRP - Maximum Retail Price Inclusive of all taxes including GST.
6896 34 + 6896 31 with support plates and wiring devices

Floor boxes for tile / marble

Cat.Nos	Description	MRP* ₹ / Unit	Pack
---------	-------------	------------------	------

for screed floor

6896 56	Lid & Trim for tile 8-15 mm thickness Material for head band & single cable outlet - stainless steel 304	7878	1
---------	----------------------------------------------------------------------------------------------------------	------	---

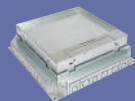

0896 04 +
6896 56

Support plates for floor boxes

77 mm width plate

6896 62	Blank plates for floor box	306	12
6896 17	Flat support plate 8 module for integration of Myrius	306	1
6896 78	Waved support plates For 4 Modules (2x2 Modules) mechanisms	928	4

50 mm reduced height floor boxes

0880 73	Back box for Concrete Floor (to be used with 0880 70)	7166	1
0880 70	Lid and Trim for Screed Floor between 50 and 70 mm. With Cover for carpet; grey RAL 7031 Can be equipped with SS finishing plate 0880 72 16 Module	7078	1
0880 72	Stainless steel finishing plate for 50 mm floor box	4410	1

Heavy duty in-screed floor box

for screed floors

Metal in-screed floor box

0896 34	Universal metal in-screed backbox	19696	1
---------	-----------------------------------	-------	---



0896 34 +
0896 83 +
0896 85

Accessories for metal in-screed floor box

0896 83	Normal load support upto 8 KN load with deflection <6 mm	19696	1
0896 84	Heavy load support upto 20 KN load with deflection <3 mm	33298	1



0896 34 +
0896 83 +
0896 86 +
0896 87

Plates for metal in-screed floor boxes

77 mm width plate

0896 85	IP 66 plain cover (cover closed) access trap for junction. No cable exit	34242	1
---------	--------------------------------------------------------------------------	-------	---

Heavy duty in screed floor box with cable exit

0896 34	Metal in-screed floor box	19696	1
---------	---------------------------	-------	---

Accessories for metal in screed floor box

0896 83	Normal load support upto 8 KN load with deflection <6 mm	19696	1
0896 84	Heavy load support up to 20 KN load with deflection <3 mm	33298	1

Bold Cat.Nos are products normally available with Legrand (India) Stockists. Cat.Nos that are not bold - delivery within 4 - 8 weeks from the date of order. Bold packing quantity is our mandatory packing. Orders to be placed by Legrand (India) Stockist in multiples of the same.

POP-UP BOXES



Our sleek new ergonomically designed pop-up boxes provide real ease of use and rapid connection solutions for mobile applications such as PCs, mobile phones, audio and video systems.





SLEEK DESIGN

Extra-slim format to blend discreetly into the office furniture or floor



SAFETY AND EASE OF USE

Soft opening cover with damper and push & slide locking system



ELEGANT FINISHES

Aluminium, bronze, stainless steel, black or white - a perfect match for furniture and decor



FUNCTIONALITY AND FLEXIBILITY

Available in 3, 2x3, 4 and 2x4 modules for custom configuration or ready assembled with low and high current functions

Heavy duty in-screed floor box for screed floors

Cat.Nos	Description	MRP* ₹ / Unit	Pack
---------	-------------	------------------	------

Plates for metal in-screed floor boxes

0896 86	IP 66 plate (cover closed and plugs not connected) with central cable exit	68548	1
0896 87	IP 14 Cable exit accessory for IP66 cover plate Cat.No 0896 86 be used as a simple access to the floor void	36630	-

Over floor trunking

Conform to Std EN 50085-2-2; For creating a link between trunking, column, mini-column, floor units or protecting cables on passageways Supplied with cover

0300 92	Over floor trunking 50 x 12 mm; length 2 m, supplied with cover; 3 Compartments;	462	54 ⁽¹⁾
0300 11	Flat angle/floor 50 x 12	182	10
0300 12	Cover joint/floor 50 x 12	234	10
0300 93	Over floor trunking 75 x 18 mm; length 2 m, supplied with cover; 3 compartments;	634	36 ⁽¹⁾
0300 18	Flat angle/floor 75 x 18	354	10
0300 19	Cover joint/floor 50 x 12	244	10
0328 00	Over floor trunking 92 x 20 mm; Length 2 m, supplied with cover; 4 Compartments, equipped with 2 adhesive strips for better floor fixing	1160	20 ⁽¹⁾
0328 07	End cap for floor duct 92 x 20	204	10
0328 03	Cover joint for floor duct 92 x 20	280	10
0328 02	Flat angle for floor duct 92 x 20	506	5

Floor boxes 3 module for screed floor and raised floor

Floor service outlet boxes - 3 modules

0896 44	Floor service outlet box - 3 modules Grey RAL 7031 To be equipped with Arteor Mechanism	1500	1
0896 49	Flush mounting box for concrete for Cat.No 0896 44	1000	1

IP 66 Floor box - 4 module

Conform to EN 60670-1 and EN 60670-23 standards (when lid is closed) / IP55 (with cable exit accessory Cat.No 0880 62)

0880 61	IP66/IK09 screwed stainl. steel floor box (with removable lid); can be equipped with cable exit accessory Cat. No 0880 62	16350	1
0880 64	IP66/IK09 hinged cover stainl. steel floor box	19670	1

Floor boxes 3 module for screed floor and raised floor

Cat.Nos	Description	MRP* ₹ / Unit	Pack
---------	-------------	------------------	------

IP 66 Floor box - 4 module

Conform to EN 60670-1 and EN 60670-23 standards (when lid is closed) / IP55 (with cable exit accessory Cat.No 0880 62)

0880 69	Auto adjustable back box for installing IP66 floor boxes in concrete floors; supplied with cover; accepts conduit dia 20 mm; min screed height 65 mm	3140	1
0880 62	IP55 cable exit accessory	18044	1

Floor access unit for raised floors

IP 20 - IK 08

0893 07	Access master box floor box that can be used as a simple access to the floor void	6998	1
---------	-----------------------------------------------------------------------------------	------	---

Pop-up type flush-mounting boxes for floor

Pop-up boxes to be equipped

Equipped with "push and slide" locking system to avoid accidental opening by feet
To be equipped with Arteor socket outlets
For installation use the flush-mounting boxes for concrete floors or the kits for raised access floors

3 modules

0540 10	Matt aluminium finish	2392	1
0540 15	Brushed brass	3414	1
0540 20	Brushed Stainless steel finish	3456	1

4 modules

0540 11	Matt aluminium finish	3178	1
0540 16	Brushed brass	4048	1
0540 21	Brushed Stainless Steel finish	4378	1
0540 26	Matt black	3956	1
0540 31	Glossy white	4052	1

6 (2 x 3) modules

0540 12	Matt aluminium finish	5316	1
0540 17	Brushed brass	7334	1
0540 22	Brushed stainless steel finish	7604	1

8 (2 x 4) modules

0540 13	Matt aluminium finish	6582	1
0540 18	Brushed brass	8800	1
0540 23	Brushed stainless steel finish	9362	1
0540 28	Matt black	8480	1
0540 33	Glossy white	8530	1

Retractable accessory for Pop Up

0540 34	RJ45 Cat 6 UTP retractable Kit - 1 module	3242	1
0540 35	RJ45 Cat 6 FTP retractable Kit - 1 module	4534	1
0540 36	USB/ Micro-USB Retractable Kit - 1 module	3070	1

* MRP - Maximum Retail Price Inclusive of all taxes including GST.
(1) Price in Meters; No of meters in Pack, Standard length 2 meters to be ordered in multiple of 2 meters.

Bold Cat.Nos are products normally available with Legrand (India) Stockists. Cat.Nos that are not bold - delivery within 4 - 8 weeks from the date of order. Bold packing quantity is our mandatory packing. Orders to be placed by Legrand (India) Stockist in multiples of the same.

Pop-up type flush-mounting boxes for floor

Cat.Nos	Description	MRP* ₹ / Unit	Pack
---------	-------------	------------------	------

Installation kits for raised access floors

Include an empty receptacle and fixing brackets for raised access floor tiles Compatible with:

- Cat. 6 data cabling
- Audio/video cabling

0540 05	3 modules	1070	1
0540 06	4 modules	1286	1
0540 07	6 (2 x 3) modules	1782	1
0540 08	8 (2 x 4) module	2198	1



0540 06

For installation of pop-up floor boxes in concrete floors

Equipped with knockouts for ø 20 and ø 25 mm conduits

Metal flush-mounting boxes

0540 00	3 modules	292	1
0540 01	4 modules	386	1
0540 02	6 (2 x 3) modules	614	1
0540 03	8 (2 x 4) modules	770	1



0540 00

Pop-up type flush-mounting boxes for furniture

Pop-up boxes to be equipped

Slim design for perfect integration into the furniture To be equipped with Arteor socket outlets Supplied alongwith installation kits for table top

4 modules

6540 14	Matt Aluminium	3110	1
6540 00	Matt steel finish	4156	1
6540 01	Glossy White	3846	1
6540 02	Matt Black	3680	1



6540 00

8 (2 x 4) modules

6540 15	Matt Aluminium	6442	1
6540 03	Matt steel finish	8994	1
6540 04	Glossy White	8184	1
6540 05	Matt Black	8136	1

Power & data desk grommets for workstation & meeting room table application

Empty power & data desk grommets

To be equipped with Arteor socket outlets, Easily retro fitted into a 60 to 80 mm diameter hole in current office desks and workspace table tops (by replacing the desk grommet) Cover opens to 180° angle to prevent breaking

For one 2P+E socket

0540 70*	White RAL 9003, to be equipped with 1 socket	2214	1
0540 71*	Black RAL 9017, to be equipped with 1 socket	2056	1



0540 70 + 0540 60

For one 2P+E socket and USB phone charger

Supplied with one USB phone charger output

5 V= 750 mA, to be wired

0540 72*	White RAL 9003 with USB, to be equipped with 1 socket	5288	1
0540 73*	Black RAL 9017 with USB, to be equipped with 1 socket	5760	1



0540 73



0540 73 + 0540 62

Power & data desk grommets for workstation & meeting room table application

Cat.Nos	Description	MRP* ₹ / Unit	Pack
---------	-------------	------------------	------

Pre-wired modules with retractable cords

For fitting on an empty power & data desktop modules (under the table top)

Automatic cable rewind when not connected, for an optimized use of the desk surface

Cat. 6 FTP

0540 65	Equipped with - 1.35 m RJ 45 Cat. 6 FTP retractable cord on the user side and - 1 x RJ 45 socket on the installation side Patch cord for connection to data network to be ordered separately	3234	1
---------	----------------------------------------------------------------------------------------------------------------------------------------------------------------------------------------------	------	---



0540 65

USB / micro USB

0540 67	Equipped with - 1.35 m retractable cord with micro USB connector, on the user side and - 0.5 m cable with USB connector on the installation side	2930	1
---------	--------------------------------------------------------------------------------------------------------------------------------------------------	------	---



0540 67

Finishing plates for empty power & data desk grommets

For fitting on an empty power & data desk grommets

0540 60	White RAL 9003	320	10
0540 62	Black RAL 9017	352	10
0540 63	Stainless steel	1284	10



0540 60



0540 62

Cable worm

0535 98	2 compartments, Length: 0.75 m White colour very suitable solution for a safe and design protection of the cabling between desk and floor	5060	1
---------	-------------------------------------------------------------------------------------------------------------------------------------------	------	---



0535 98

Flush mounting power and data module

A ready to embed solution for all dry support with thickness between 2 and 40 mm. Conform to standard NFC 61-314 which ensures safety of the user

Aesthetic product (no visible screw), thickness of 6mm only.

Product available in 8 and 12 module, with the option of configuring power sockets, data, AV, protection etc. 3 Finishes; white/ black and aluminium

Flush mounting power and data module to be equipped

Aluminium extensions with cable guide (reversible) To be equipped with Arteor sockets

8 module; length - 180 mm

0535 60	Flush 8 mod white finish	5778	1
0535 61	Flush 8 mod aluminium finish	6816	1
0535 62	Flush 8 mod black finish	5628	1



0535 60

12 module; length - 270 mm

0535 63	Flush 12 mod white finish	6078	1
0535 64	Flush 12 mod aluminium finish	7324	1
0535 65	Flush 12 mod black finish	6132	1

* MRP - Maximum Retail Price Inclusive of all taxes including GST.

* Finishing Plates to be ordered separately

Red Cat.Nos - new products

Bold Cat.Nos are products normally available with Legrand (India) Stockists. Cat.Nos that are not bold - delivery within 4 - 8 weeks from the date of order. Bold packing quantity is our mandatory packing. Orders to be placed by Legrand (India) Stockist in multiples of the same.

DLP-S

UNIVERSAL TRUNKING

FOR THE ESSENTIALS

- Traditional installation method with modular or with universal supports
- Compatible with all types of 45 mm mechanisms (like Arteor)

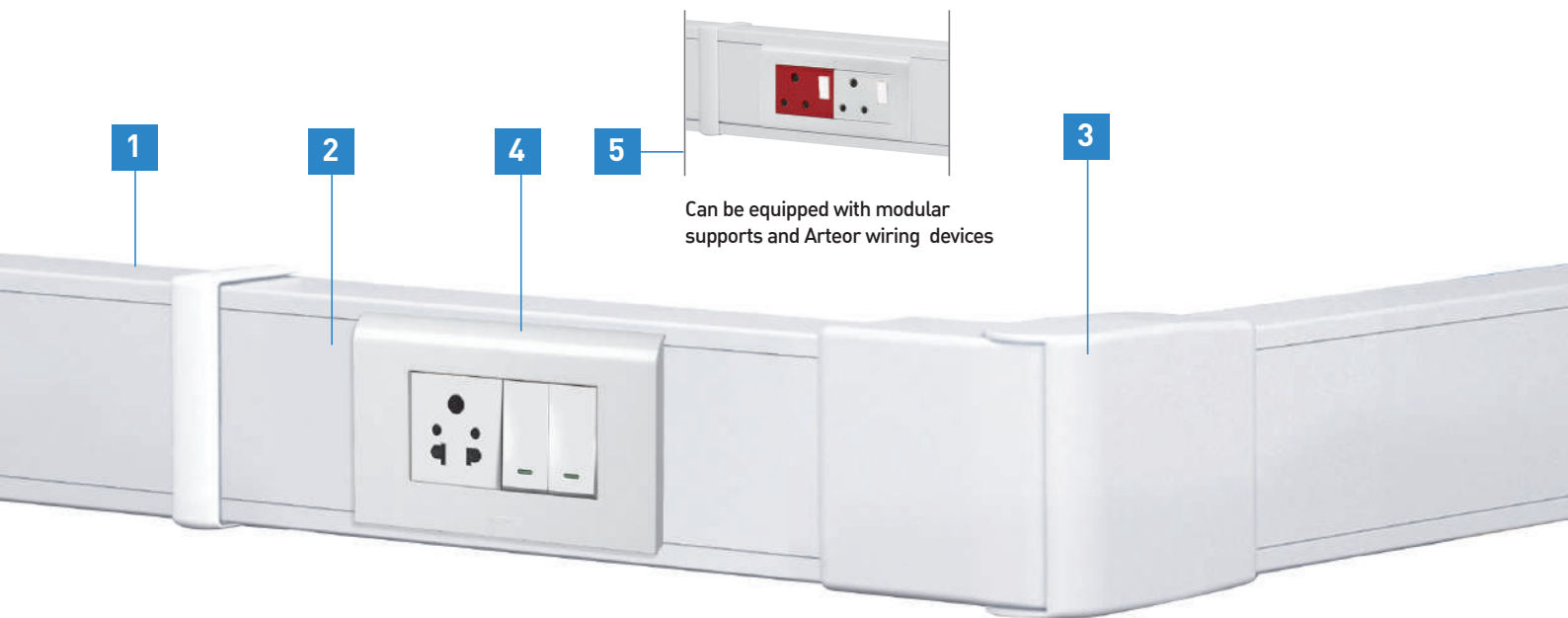

1 Rigid profiles with perforations



2 Self-guiding cover



3 Ready to install accessories



4 Myrius single module switch with brackets

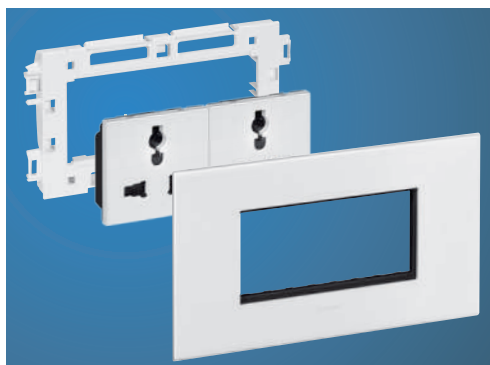

5 Arteor sockets and modular support

DLP PVC adaptable trunking systems for installations base, covers, partitions, finishing accessories and mounting wiring accessories

Selection chart for Installation of trunking, Accessories and Arteor™

Trunking			Covers	Clip on partition		Arteor™ frames					
Number of compartments	Cover(s) width	Section (mm)									
			Flexible	Partitions separation	Plastic	Aluminium	1 module	2 module	3 module	4 module	6 module
 0104 12	1 	80 x 50	0105 21	0105 82	-	-	-	0109 52	0109 31	0109 54	0109 56
	2 		0105 20	0105 82	0104 72	0111 06	0109 10	-	-	-	-
 0104 22	1 	105 x 50	0105 22	0105 82	-	-	-	0109 92	0109 93	0109 94	0109 96
	2 		0105 20	0105 82	0104 72	0111 06	0109 10	-	-	-	-
	2 		0105 20 + 0105 22	0105 82	0104 72	0111 06	0109 10	0109 92	0109 93	0109 94	0109 96
	3 		0105 20	0105 82	0104 72 x 2	0111 06 x 2	0109 10	-	-	-	-
 0104 32	1 	150 x 50	0105 24	0105 82	-	-	-	-	-	-	-
	2 		0105 21	0105 82	0104 72	0111 06	-	0109 52	0109 31	0109 54	0109 56
	2 		0105 20 + 0105 22	0105 82	0104 72	0111 06	0109 10	0109 92	0109 93	0109 94	0109 96
	3 		0105 20	0105 82	0104 72 x 2	0111 06 x 2	0109 10	-	-	-	-
	1 		0105 26	0105 82	-	-	-	-	-	-	-
	2 		0105 22	0105 82	0104 72	0111 06	-	0109 92	0109 93	0109 94	0109 96
 0104 52	2 	195 x 50	0105 82	0104 72	0111 06	0109 10	-	-	-	-	
	3 		0105 82	0104 72 x 2	0111 06 x 2	0109 10	0109 92	0109 93	0109 94	0109 62	
	3 		0105 82	0104 72 x 2	0111 06 x 2	0109 10	0109 52	0109 31	0109 54	0109 56	
	4 		0105 20	0105 82	0104 72 x 3	0111 06 x 3	0109 10	-	-	-	-

Selection chart for Installation trunking, Accessories and Arteor™

Section (mm)	Wall crossing 	Capacity change 	Partition junction 	Cable tie base 	Insulating unit for Arteor™ modules 	Earth Link
					2 Module Combined to get 4/6 Module	
80 x 50 / 105 x 50	0106 98	0106 87 + 0106 88 + 0106 89 (to be used for partition)	0106 89	0308 81	0109 27	0111 88
150 x 50 / 195 x 50	0106 99					

Selection chart for Installation of trunking, Additional accessories

Cover	Bases		Internal angles 80° - 100°			External angles 60° - 120°			Flat angles		Flat junction			
Joint for covers	Base joint	End caps	Angles	Partition junction	VDI access.	Angles	Partition junction	VDI access.	Angles	VDI access.	Angles	Partition junction	VDI access.	Clips
0108 01	0106 91	0107 22	0106 02	-	0107 80	0106 22	-	0107 81	0107 67	0107 82	0107 32	-	0107 83	0106 82
0108 02	0106 91	0107 02	0106 02	-	0107 80	0106 22	-	0107 81	0107 85	0107 82	0107 32	-	0107 83	0106 82
0108 00	0106 91	0107 02	0106 02	0106 11	-	0106 22	0106 32	-	-	-	0107 32	0107 42	-	0106 82
0108 04	0106 91	0107 06	0106 02	-	-	0106 22	-	-	0107 89	-	0107 32	-	-	0106 86
0108 01	0106 91	0107 06	0106 02	0106 11	0107 80	0106 22	0106 32	0107 81	0107 89	0107 82	0107 32	0107 42	0107 83	0106 82
0108 02	0106 91	0107 06	0106 02	0106 11	0107 80	0106 22	0106 32	0107 81	0107 89	0107 82	0107 32	0107 42	0107 83	0106 82
0108 00	0106 91	0107 06	0106 02	0106 11 x 2	-	0106 22	0106 32 x 2	-	0107 89	-	0107 32	0107 42	-	0106 82
0108 06	0106 91	0107 07	0106 02	-	-	0106 22	-	-	0107 92	-	0107 32	-	-	0106 86
0108 02	0106 91	0107 07	0106 02	0106 11	0107 80	0106 22	0106 32	0107 81	0107 92	0107 82	0107 32	0107 42	0107 83	0106 82
	0106 91	0107 07	0106 02	0106 11	0107 80	0106 22	0106 32	0107 81	0107 92	0107 82	0107 32	0107 42	0107 83	
	0106 91	0107 07	0106 02	0106 11 x 2	0107 80	0106 22	0106 32 x 2	0107 81	0107 92	0107 82	0107 32	0107 42	0107 83	0106 82
	0106 91	0107 07	0106 02	0106 11 x 2	0107 80	0106 22	0106 32 x 2	0107 81	0107 92	0107 82	0107 32	0107 42	0107 83	0106 82
0108 00	0106 91	0107 07	0106 02	0106 11 x 3	-	0106 22	0106 32 x 3	-	0107 92	-	0107 32	0107 42	-	0106 82

DLP mini trunking systems for cable distribution







■ Selection chart for DLP mini trunking

	Length	Finishing Accessories				Junction Elements
WHITE	2 m	End cap	Internal angle	External angle	Flat angle	Flat junction
32 x 12.5	0300 15	0312 03	0302 51	0302 51	0302 53	0302 54
32 x 16	0308 04	0312 07	0333 25	0333 25	0333 27	0333 30
32 x 20	0300 17	0312 09	0302 71	0302 71	0302 73	0302 74



DLP aluminium trunking system

selection chart of sections, covers and accessories
selection chart of support for wiring accessories

TRUNKING AND ACCESSORIES

Width (mm)	Nos. of compartments	Covers width	Cat. nos.	Rigid covers 				 Cover Joint	 Trunking Base Joint
				65 mm width	85 mm width	130 mm width	180 mm width		
105 x 50	1 	1 x 85	111 00	-	0111 11	-	-	0111 63	0111 66
150 x 50	2 	2 x 65	0111 02	2 x 0111 10	-	-	-	0111 62	0111 66
195 x 50	2 	2 x 85	0111 04	-	2 x 0111 11	-	-	0111 63	0111 66

SUPPORT FOR WIRING ACCESSORIES

60 mm fixing centers : Arteur™	Cover depths	
No of module	65 mm	85 mm
2 modules 	0112 02	0112 12
3 modules 	0112 03	0112 13
4 modules 	0112 04	0112 14
6 modules 	0112 06	0112 16

Insulation resistance : the entire DLP range, including accessories, have insulation resistance above 5 Megaohms

DLP TRUNKING SYSTEM ALUMINIUM

with aluminium adaptable
DLP trunking,
get better styling too !

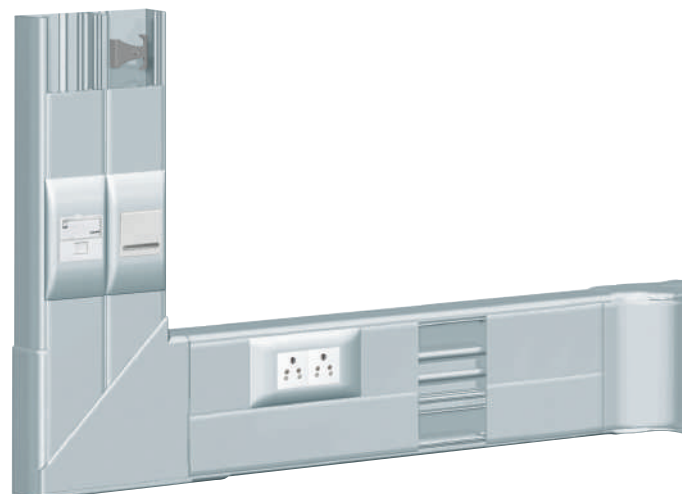

SELECTION CHART OF ACCESSORIES (continued)

Dividers		End cap	Internal angles	External angles	Flat angles	Junction Flat junction*	Clips	Earth link
Clip-on partition	Separation partition							
-	0111 08	0111 58	0112 21	0112 32	0112 43	0112 51	0106 82	0111 88
0111 06	0111 08	0111 60	0112 27	0112 38	0112 45	0112 51	0106 82	0111 88
0111 06	0111 08	0111 61	0112 29	0112 40	0112 47	0112 51	0106 82	0111 88

(1) To be used with angle covers. (2) To be used with rigid covers

TABLE OF CAPACITIES

	Crosssection (mm ²) Max. Ø (mm ²)	105 x 50	150 x 50		195 x 50	
		cover 85	cover 65	cover 65	cover 85	cover 85
Trunking only	Cross-section	4330	3020	3020	5350	5350
	Max. Ø	28	43	43	55	55
With Arteor / support	Cross-section	2300	1470	1470	3320	3320
	Max. Ø	2 x 24	18	18	33	33

*To tap off 105 mm wide trunking with 85 mm cover

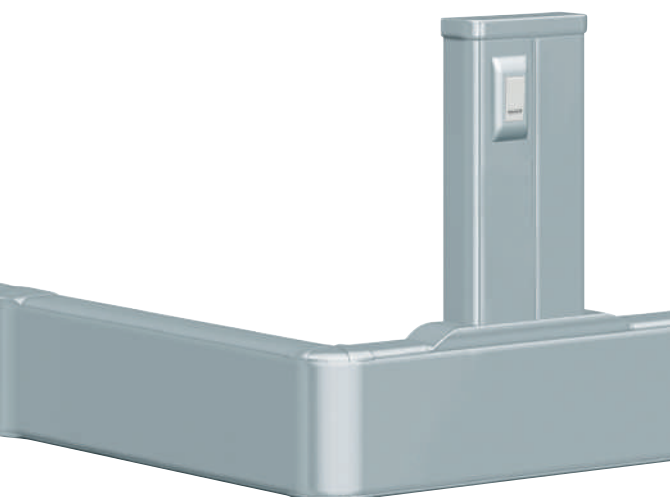

SAVE TIME

- Flexibility : multi-covers
- Removable separation
- Angles delivered pre-cut, ready to use
- Fast fixing device support
- Uniform colours for the entire installation
- Arteor™ wiring accessories go with aluminium adaptable DLP trunking

Snap-on trunking routing sections and accessories

Cat.Nos	Description	MRP* ₹ / Unit	Pack
---------	-------------	------------------	------

Snap-on trunking

Monobloc: Body + Cover, can take any Arteor wiring accessory

0756 01	Snap-on trunking 50 x 80 1 - compartment	990	20 ⁽¹⁾
0756 02	Snap-on trunking 50 x 105 1 - compartment	1260	12 ⁽¹⁾
0756 03	Snap-on trunking 50 x 130 2 - compartments	1736	12 ⁽¹⁾
0756 04	Snap-on trunking 50 x 145 2 - compartments	2238	8 ⁽¹⁾
0756 06	Snap-on trunking 50 x 180 3 - compartments	2464	8 ⁽¹⁾

Divider

0756 09	Divider	216	26 ⁽¹⁾
---------	---------	-----	-------------------

Extra cover

0756 08	Width 45 mm	386	20 ⁽¹⁾
---------	-------------	-----	-------------------

Joints

Fishplate Body joint

0756 61	Set of 2 Body joints	350	10
0756 62	Set of 2 Body joints	462	10
0756 63	Set of 2 Body joints	406	10

Stick-on body joint

0756 66	For top part of body	226	20
0756 67	For bottom part of body	272	20

Cover joint

0756 69	Cover joint, width 45 mm	120	10
---------	--------------------------	-----	----

End caps

0756 11	Left or right end cap	202	10
0756 12	Left or right end cap	202	10
0756 13	Left or right end cap	332	5
0756 14	Left or right end cap	346	5
0756 16	Left or right end cap	378	5

Height spacer

0105 80	Colour charcoal grey for fitting 15 mm from the ground	504	24 ⁽¹⁾
---------	--------------------------------------------------------	-----	-------------------

Soluclip accessory

Fishplate body joint

0756 90	For installation with any Arteor function	172	10
---------	-------------------------------------------	-----	----

Angles

Internal angles

0756 21	varies from 80° to 100°	462	10
0756 22	varies from 80° to 100°	644	10
0756 23	varies from 80° to 100°	1084	5
0756 24	varies from 80° to 100°	1742	5
0756 26	varies from 80° to 100°	1538	5

External angles

0756 31	varies from 85° to 120°	964	10
0756 32	varies from 85° to 120°	1476	10
0756 33	varies from 85° to 120°	2004	5
0756 34	varies from 85° to 120°	2360	5
0756 36	varies from 85° to 120°	2800	5

Flat angles

0756 41	Flat angle at 90°	564	10
0756 42	Flat angle at 90°	740	10
0756 43	Flat angle at 90°	1476	5
0756 44	Flat angle at 90°	1382	5
0756 46	Flat angle at 90°	2766	5

Snap-on trunking routing sections and accessories

Cat.Nos	Description	MRP* ₹ / Unit	Pack
---------	-------------	------------------	------

Junctions

Flat junctions with 80 mm width

0756 71	Creates a junction	774	5
0756 72	Creates a junction	774	5

For 105 mm wide upward trunking

0756 75	Creates a junction	758	5
0756 76	Creates a junction	828	5

Angled junction

Must be used in conjunction with an internal angle

0756 81	Creates a junction in an internal angle	1706	5
---------	-----------------------------------------	------	---

Junction with floor duct

0756 88	Creates a junction with a floor duct size 50 x 12 mm or 92 x 20 mm	894	5
---------	--------------------------------------------------------------------	-----	---

DLP PVC trunking system Mini-trunking system

Mini-trunking - 32 x 12.5 mm

0300 15	Without central partition	110	80 ⁽¹⁾
---------	---------------------------	-----	-------------------

Finishing accessories

0312 03	End cap right or left	58	20/400
0302 51	Changeable internal - external angle from 60° to 120°	80	10/100
0302 53	Changeable flat angle from 85° to 95°	90	10/100
0302 54	Flat junction	114	10/200
0336 03	White 32 x 10/12.5 Cover Joint	112	20

Mini-trunking - 32 x 16 mm

0308 04	Without central partition	140	60 ⁽¹⁾
---------	---------------------------	-----	-------------------

Finishing accessories

0312 07	End cap right or left	86	10
0333 25	Changeable internal - external angle from 60° to 120°	98	10
0333 27	Changeable flat angle from 85° to 95°	96	10
0333 30	Flat junction	134	10
0336 04	White 32 x 16/20 Cover Joint	112	20

Mini-trunking - 32 x 20 mm

0300 17	Without partition	152	50 ⁽¹⁾
---------	-------------------	-----	-------------------

Finishing accessories

0312 09	End cap right or left	120	10
0302 71	Changeable internal - external angle from 60° to 120°	114	10
0302 73	Changeable flat angle from 85° to 95°	98	10
0302 74	Flat junction	112	10
0336 04	White 32 x 16/20 Cover Joint	112	20

* MRP - Maximum Retail Price Inclusive of all taxes including GST.
(1) Price in Meters; No of meters in Pack, Standard length 2 meters to be ordered in multiples of 2 meters

Bold Cat.Nos are products normally available with Legrand (India) Stockists. Cat.Nos that are not bold - delivery within 4 - 8 weeks from the date of order. Bold packing quantity is our mandatory packing. Orders to be placed by Legrand (India) Stockist in multiples of the same.

DLP PVC trunking system and accessories - trunking and fittings

Cat.Nos	Description	MRP* ₹ / Unit	Pack
---------	-------------	------------------	------

Trunking

Bodies

Supplied without cover

0104 12	80 x 50 mm	626	20 ⁽¹⁾
0104 22	105 x 50 mm	778	20 ⁽¹⁾
0104 32	150 x 50 mm	1316	10 ⁽¹⁾
0104 52	195 x 50 mm	1744	8 ⁽¹⁾

Flexible cover

Fits onto the whole branch including in internal or external angles

0105 20	Full covers width 40 mm	310	20 ⁽¹⁾
0105 21	Full cover width 65 mm	304	24 ⁽¹⁾
0105 22	Full cover width 85 mm	352	20 ⁽¹⁾
0105 24	Full cover width 130 mm	740	8
0105 26	Full cover width 180 mm	944	8 ⁽¹⁾

Partitions

0105 82	Separation partition	206	24 ⁽¹⁾
0104 72	Clip-on partition - Plastic	304	48 ⁽¹⁾
0111 06	Clip-on partition - Aluminium	1218	12 ⁽¹⁾

Joints

0106 91	Body / Base joint - For aligning bases during installation	70	20/200
0108 00	Cover joint for 40 mm width	142	10/100
0108 01	Cover joint for 65 mm width	120	10/100
0108 02	Cover joint for 85 mm width	184	10/100
0108 04	Cover joint for 130 mm width	312	10/100
0108 06	Cover joint for 180 mm width	288	10/100

Angles and end caps

Internal and external angles

Include the 2 components for the top and bottom of the trunking on which the flexible cover is fitted

0106 02	Internal angle, adjustable from 80° to 100°	446	10/40
0106 22	External angle, adjustable from 60° to 120°	434	10/50

Flat angle

0107 67	90° flat angle	616	10
0107 85	90° flat angle	644	10
0107 89	90° flat angle	2136	5
0107 92	90° flat angle	2740	2

End cap

0107 02	Left or right end cap	160	20/100
0107 06	Left or right end cap	310	10/50
0107 07	Left or right end cap	368	5/50
0107 22	Left or right end cap	172	10

Junctions

0107 32	Flat junctions to tap-off to a branch smaller than 50 x 105	798	10
0107 35	For specific size tap-off to 80 mm wide branch	464	5
0107 36	For tap-off to an 105 mm wide branch equipped with an 85 mm cover	460	5/25
0107 37	Flat junction for specific size - tap off to an 105 mm wide branch with 65 mm cover	460	5/25

* MRP - Maximum Retail Price Inclusive of all taxes including GST.
(1) Price in Meters; No of meters in Pack, Standard length 2 meters to be ordered in multiples of 2 meters

DLP PVC trunking system and accessories - trunking and fittings

Cat.Nos	Description	MRP* ₹ / Unit	Pack
---------	-------------	------------------	------

Junctions

Partition junction

0106 11	For internal angles	268	5/50
0106 32	For external angles	406	5/50
0107 42	For flat angles	956	5/25

Accessories

Holding cables in place

0106 82	Clip for 65 mm width cover	62	50
0106 86	Clip for 130 mm width cover	106	50

VDI accessories

0107 80	For internal angles	690	5/50
0107 81	For external angles	742	5/50
0107 82	For flat angles	790	5/50
0107 83	For flat junctions	952	5/50

Additional accessories

0106 98	Wall crossing for trunking 80 to 150 mm width	766	5/25
0106 99	Wall crossing for trunking 195 mm width	796	5/25
0308 81	Cable tie base	26	100/1000
0111 88	Earthing link	294	20/500

Capacity Change

Allows to increase 15 mm height of trunking to preserve the space of wiring with a flat junction or a support equipment

0106 87	Raise, length 57 cm	276	40
0106 88	Set of 4 accessories to change capacity of the body	348	10/100
0106 89	Set of 2 accessories to change height of partition (to be used)	350	5/50

Supports for mounting wiring accessories

Arteor™ supports

Clip-on supports which can be fitted side by side
Supplied with finishing plate

0109 10	1 modules-for 40 mm cover	158	5/50
0109 52	2 modules-for 65 mm cover	154	20
0109 92	2 modules-for 85 mm cover	162	20
0109 31	3 modules-for 65 mm cover	210	5/50
0109 93	3 modules-for 85 mm cover	224	5/50
0109 54	4 modules-for 65 mm cover	238	10/50
0109 94	4 modules-for 85 mm cover	248	20
0109 56	6 modules-for 65 mm cover	256	5/25
0109 96	6 modules-for 85 mm cover	314	10
0109 27	Insulation unit for 2 modules (Arteor™) can be fitted together to create 4/6/8 module supports	270	10/100

Legrand Lexic supports

0109 25	For 2 modules for 65 mm cover (2 comp.)	940	5
0109 35	For 3 modules for 85 mm cover (2 comp.)	1112	5
0109 65	For 6 modules for 130 mm cover (1 comp.)	1248	5
0109 00	Hypra socket support - for 130 mm cover	1806	5

Bold Cat.Nos are products normally available with Legrand (India) Stockists. Cat.Nos that are not bold - delivery within 4 - 8 weeks from the date of order. Bold packing quantity is our mandatory packing. Orders to be placed by Legrand (India) Stockist in multiples of the same.

DLP-S PVC trunking system and accessories - trunking and fittings

Cat.Nos	Description	MRP* ₹ / Unit	Pack
---------	-------------	------------------	------

Trunking

Body with cover

6380 38	100 x 50	896	12 ⁽¹⁾
---------	----------	-----	-------------------

Partition

6380 08	Separation Partition	166	32 ⁽¹⁾
---------	----------------------	-----	-------------------

Joints

6380 36	Body / Base Joint	56	10
6380 01	Cover joint	148	50

Angles and end caps

Variable angles

6380 31	Variable Internal Angle	348	10
6380 32	Variable External Angle	348	10

Fixed angles

6380 11	Fixed Internal Angle	224	20
6380 12	Fixed External Angle	226	20

Flat angle

6380 13	Flat Angle	492	16
---------	------------	-----	----

End cap

6380 35	End Cap	128	20
---------	---------	-----	----

Bracket

6380 05	Universal Bracket (set of 2 pcs.)	110	10/100
---------	--------------------------------------	-----	--------

Junction

6380 34	Tee / Flat Junction	1088	5
---------	---------------------	------	---

Supports for mounting wiring accessories

Arteor™ & Myrius supports

Clip-on supports which can be fitted side by side
Supplied with finishing plate

6380 71	2 modules frame	154	10
6380 72	4 modules frame	220	5
6380 73	6 modules frame	318	5

DLP aluminium adaptable trunking system

Body

0111 00	100 x 50 Supplied without cover	3908	8 ⁽¹⁾
0111 02	150 x 50 Supplied without cover allow fitting of partial covers - 2 compartments	4922	4 ⁽¹⁾
0111 04	195 x 50 Supplied without cover allow fitting of partial covers - 2 compartments	5772	4 ⁽¹⁾

Cover and partition

0111 10	Rigid cover 65 mm width	982	16 ⁽¹⁾
0111 11	Rigid cover 85 mm width	1288	16 ⁽¹⁾
0111 08	Separation partition	678	24 ⁽¹⁾
0111 06	Clip on Partition	1218	12 ⁽¹⁾

Finishing accessories

0111 66	Base / Body joint	234	20/100
0111 62	Cover joint - 65 mm	320	10
0111 63	Cover joint - 85 mm	340	10/100
0111 58	End cap	696	20/100
0111 60	End cap	1488	10
0111 61	End cap	1764	10

* MRP - Maximum Retail Price Inclusive of all taxes including GST.
(1) Price in Meters; No of meters in Pack, Standard length 2 meters to be ordered in multiples of 2 meters

DLP aluminium adaptable trunking system - trunking and fittings

Cat.Nos	Description	MRP* ₹ / Unit	Pack
---------	-------------	------------------	------

Finishing accessories

0112 43	Flat angle for 85 mm cover	5984	10
0112 45	Flat angle for cover 65/130 mm	10078	5
0112 47	Flat angle for cover 85/180 mm	10394	2
0112 32	External angle for 85 mm cover	7462	1
0112 38	External angle 2 cover 65 mm	15450	1
0112 40	External angle 2 covers 85mm	16132	1
0112 21	Internal angle for 85 mm cover	6714	1
0112 27	Internal angle 2 Covers 65 mm	15338	1
0112 29	Internal angle 2 Cover 85 mm	16018	1
0112 51	Flat junction To tap off to 105 mm wide trunking equipped with 85 mm cover	8124	5

Supports for Arteor™ for cover 85 mm width

0112 12	2 modules	486	20
0112 13	3 modules	570	20
0112 14	4 modules	572	20
0112 16	6 modules	762	10

Supports for Arteor™ for cover 65 mm width

0112 02	2 modules	442	20
0112 03	3 modules	540	20
0112 04	4 modules	562	20
0112 06	6 modules	660	10

Cabling accessories

0106 82	Clip for 65 mm and 85 mm covers	62	50
0111 88	Earth link	294	20
0308 81	Base for cable ties	26	100

Aluminium Snap-on Columns 2 Compartments mini - columns

	Can be equipped with ovaline kits Cat.Nos 6530 63/64/65		
6530 23	White finish PVC body and covers Height 0.68 m	10502	1
6530 24	Aluminium finish Aluminium body and covers Height 0.68 m	14826	1

Accessories for 1 or 2 compartments mini- columns

6530 84	Table - white finish	29036	1
6530 86	Movable foot - white finish	19152	1
6530 87	Movable foot - aluminum finish	20140	1
6530 88	Set of 4 wheels with cable holder	13218	1

Bold Cat.Nos are products normally available with Legrand (India) Stockists. Cat.Nos that are not bold - delivery within 4 - 8 weeks from the date of order. Bold packing quantity is our mandatory packing. Orders to be placed by Legrand (India) Stockist in multiples of the same.

LIGHTING MANAGEMENT SOLUTIONS

INTRODUCING SMART RANGE OF STANDALONE SENSORS TO PUT A STOP TO ENERGY WASTE



048953
PIR miniature



048955
Microwave



048806
Dual Technology

FEATURES



Dali Dimming
with on/off



Configuration
By App



Adjustable
Time delay



Day Light
harvesting



Occupancy/ Vacancy



Sensitivity
adjustment



Movement detectors

Cat.Nos	Description	MRP* ₹ / Unit	Pack
---------	-------------	------------------	------

Movement detectors for lighting control

IP 20-IP 55 direction movement detector with 180- 360° detection angle. For 2000 Watt incandescent, 230 V halogen," 1000 VA fluroscet



0488 06

0488 99	PIR ceiling dectector sensor	4686	1/10
0488 06	Dual ceiling switch sensor 8.5A	9854	1/10
0488 07	PIR ceiling switch sensor	9938	1/10
0488 17	Pir switch sensor corridor	11144	1/10
0488 04	PIR switch sensor 2 outputs	11344	1/10
0489 33	PIR WALL SWI. SENS. 270 degree	21360	1/10
0489 32	PIR ceiling mounted for warehouse	19276	1/10
0489 53	PIR ceiling mounted with DALI Dimming	14904	1/10
0489 54	PIR ceiling mounted	13478	1/10
0489 55	Microwave ceiling mounted with DALI dimming	16270	1/10
0488 75	Surface mount box	782	1/10
0882 30	Configuration tool	12585	1/10
0882 40	Configuration gateway	22362	1/10

NEW!

* MRP - Maximum Retail Price Inclusive of all taxes including GST.
Red Cat.Nos - new products

Video door entry systems

Cat.Nos	Description	MRP* ₹ / Unit	Pack
---------	-------------	------------------	------

Colour image digital video door entry system kit



3695 80



3695 70



3695 60



3695 50

3695 80	Basic video kit 7" hands free	13798	1
3695 70	Basic video kit 7" handset	14708	1
3695 60	Basic video kit 4.3" hands free	12764	1
3695 50	Basic video kit 4.3" handset	13638	1
3695 85	Basic video additional IU 7" hands free	8148	1
3695 75	Basic video additional IU 7" handset	9264	1
3695 65	Basic video additional IU 4.3" hands free	7324	1
3695 55	Basic video additional IU 4.3" handset	8164	1
3695 96	Basic additional video EP	5812	1
3695 95	Basic additional audio EP	3414	1
3695 97	Basic EP angle bracket	730	1

Bold Cat.Nos are products normally available with Legrand (India) Stockists. Cat.Nos that are not bold - delivery within 4 - 8 weeks from the date of order. Bold packing quantity is our mandatory packing. Orders to be placed by Legrand (India) Stockist in multiples of the same.

P17 TEMPRA PRO

ALWAYS ENSURING
CONTINUITY OF SERVICE

By updating its IP44 and IP 66/67 range of industrial sockets, Legrand is meeting the expectations of professional users. New benefits in terms of safety, implementation, design & ergonomics guarantee the longevity of this family of products, which has already proven itself over time.



IP44

SOCKETS FOR INTERNAL AND EXTERNAL USE, PROTECTED AGAINST PROJECTIONS OF WATER (BUT NOT EXPOSED TO DIRECT JETS)



Straight plugs



Mobile sockets



Panel mounting sockets

A TRANSFORMED RANGE WHICH HARMONISES WITH THE LEGRAND INDUSTRIAL SOCKETS RANGE

- From 16 to 32 A
- 2 P+ E / 3 P+E / 3 P+N+E
- From 100 to 500 VA
- 50/60 Hz
- Screw connection



AIRPORTS, DATA CENTRES,
HOTELS, ETC. P17 TEMPRA PRO IS
IDEAL FOR ALL MAJOR PROJECTS

IP66/67/69*

WEATHERPROOF SOCKETS THAT
CAN WITHSTAND TEMPORARY
IMMERSION (RAIN, FLOODS, ETC)



Surface mounting
sockets



Straight plugs

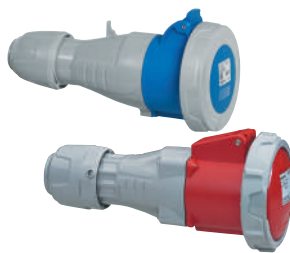

Mobile sockets



Panel mounting
sockets



Surface mounting
sockets

- From 16 to 125 A
- 2 P+ E / 3 P+E / 3 P+N+E
- From 100 to 500 VA
- 50/60 Hz
- Screw connection

* On 63 and 125 A plugs and mobile sockets

P17 TEMPRA PRO

ENSURING EASE OF USE AND SAFETY

The new P17 Tempra Pro range has been subject to extensive research in terms of design and safety in order to make life safer and easier for the user. Good product gripping, compact dimensions for use in tight spaces, easier handling, etc. Compliance with standards, anti-corrosion treated materials and components, etc. A comprehensive set of solutions which comply with the standards.

AN INNOVATIVE DESIGN THAT COMPLIES WITH STANDARDS IEC 60309-1 AND 2 AND RESPECTS THE ENVIRONMENT

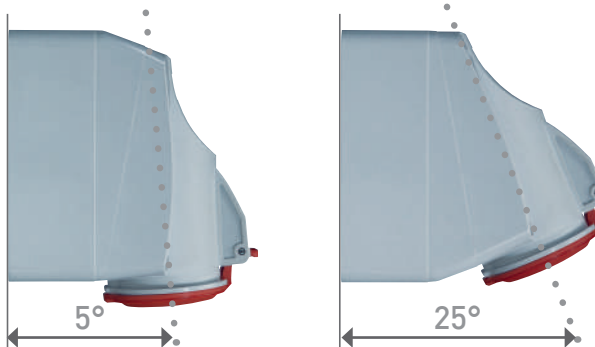

1 2 MOUNTING POSITIONS

To solve the problem of limited space, the surface mounting sockets offer 2 different mounting positions (5° or 25°) which allow users to adapt to the space available without changing the box.

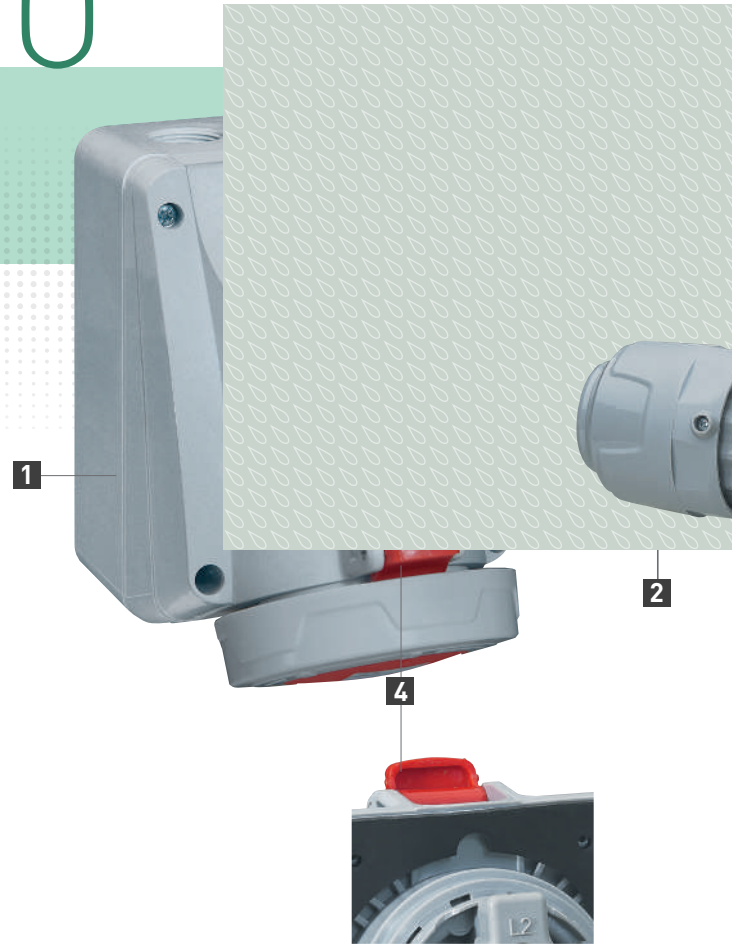

2 CABLE GRIP

Captive cable grip with anti-vibration system holds the cable in place permanently. The 63 and 125 A products are also equipped with a locking screw.



3 EASE OF HANDLING

Gripping areas on the body of the mobile products and the cable grip.

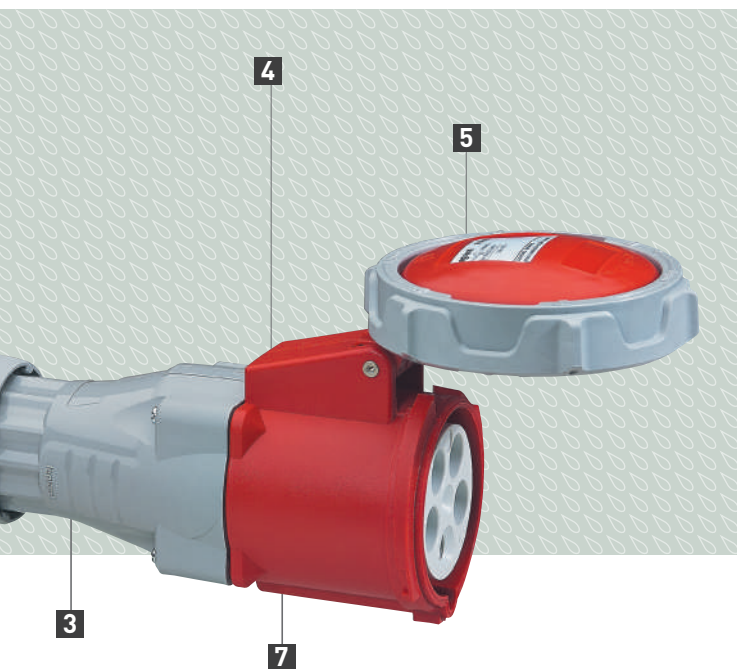

SAFETY & THE ENVIRONMENT

SAFETY

Connection terminals compliant with standards IEC 60 309 1 & 2

Production sites certified according to ISO 14001 and ISO 9001

Very high resistance to chemical products. Plugs and sockets made of polyamide 6

Anti-corrosion treated screws, stainless steel springs for the socket covers

Resistant to temperatures of -25°C to +40°C

ENVIRONMENT

Halogen-free recyclable materials (silicone, PVC) for IP 44 products

Grouped packaging in boxes

PEP products (Eco Passport)



4 OPENING LEVER

For easier connection / disconnection. Cover held open on panel sockets and surface mounting sockets.



5 POSITION MARKING

Information engraved on the ring cover of IP66/67 products means the user can check quickly whether it is in the open or closed position. Marking on cover and flap for easy identification.



6 RIVETED METAL SHAFT

For 63 and 125 A products the riveted metal shaft ensures more strength. The notched locking ring facilitates the locking / unlocking operations.

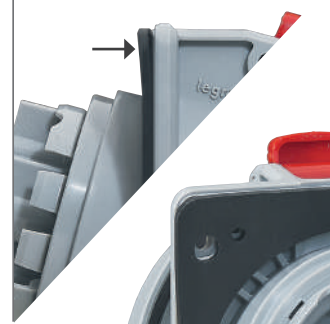

7 WEATHERPROOF SEALING

For panel mounting sockets.

P17 Tempra Pro IP 44 - LV 16 and 32 A - sockets and plugs

Cat.Nos	Description	MRP* ₹ / Unit	Pack
---------	-------------	------------------	------

Surface mounting sockets

5551 54	200/250 V \sim , 16 A 2P+E	632	10
5551 58	380/415 V \sim , 16 A 3P+E	780	10
5551 59	380/415 V \sim , 16 A 3P+N+E	826	10
5552 54	200/250 V \sim , 32 A 2P+E	792	5
5552 58	380/415 V \sim , 32 A 3P+E	988	10
5552 59	380/415 V \sim , 32 A 3P+N+E	1048	10

Panel mounting sockets inclined outlet

5551 84	200/250 V \sim , 16 A 2P+E	392	10
5551 88	380/415 V \sim , 16 A 3P+E	576	10
5551 89	380/415 V \sim , 16 A 3P+N+E	608	10
5552 84	200/250 V \sim , 32 A 2P+E	602	10
5552 88	380/415 V \sim , 32 A 3P+E	764	10
5552 89	380/415 V \sim , 32 A 3P+N+E	810	10

Mobile sockets

5551 04	200/250 V \sim , 16 A 2P+E	510	10
5551 08	380/415 V \sim , 16 A 3P+E	568	10
5551 09	380/415 V \sim , 16 A 3P+N+E	602	10
5552 14	200/250 V \sim , 32 A 2P+E	676	10
5552 18	380/415 V \sim , 32 A 3P+E	814	10
5552 19	380/415 V \sim , 32 A 3P+N+E	860	10

Straight plugs

5551 24	200/250 V \sim , 16 A 2P+E	362	10
5551 28	380/415 V \sim , 16 A 3P+E	442	10
5551 29	380/415 V \sim , 16 A 3P+N+E	468	10
5552 34	200/250 V \sim , 32 A 2P+E	546	10
5552 38	380/415 V \sim , 32 A 3P+E	624	10
5552 39	380/415 V \sim , 32 A 3P+N+E	662	10

P17 Tempra - domestic pin configuration 16 A - 250 V \sim

Flush-mounting boxes

0577 21	For 2 panel mounting sockets With single fixing centres 70 x 70 mm - 16 A	3616	3
0577 22	For 1 panel mounting socket With single fixing centres 70 x 70 mm - 16 or 32 A (32 A to be fixed horizontally)	2168	3

* MRP - Maximum Retail Price Inclusive of all taxes including GST.

P17 Tempra Pro IP 66/67 LV 16 and 32 A

Cat.Nos	Polarity	MRP* ₹ / Unit	Pack
---------	----------	------------------	------

Surface mounting sockets

5553 54	200/250 V \sim , 16 A 2P+E	1058	5
5553 58	380/415 V \sim , 16 A 3P+E	1178	5
5553 59	380/415 V \sim , 16 A 3P+N+E	1280	5
5554 54	200/250 V \sim , 32 A 2P+E	1254	5
5554 55	200/250 V \sim , 32 A 3P+E	2166	5
5554 59	380/415 V \sim , 32 A 3P+N+E	2348	5

Panel mounting sockets

5553 84	200/250 V \sim , 16 A 2P+E	772	5
5553 88	380/415 V \sim , 16 A 3P+E	824	5
5553 89	380/415 V \sim , 16 A 3P+N+E	874	5
5554 84	200/250 V \sim , 32 A 2P+E	984	5
5554 88	380/415 V \sim , 32 A 3P+E	1126	5
5554 89	380/415 V \sim , 32 A 3P+N+E	1194	5

Mobile sockets

5553 04	200/250 V \sim , 16 A 2P+E	948	5
5553 08	380/415 V \sim , 16 A 3P+E	1178	5
5553 09	380/415 V \sim , 16 A 3P+N+E	1248	5
5554 14	200/250 V \sim , 32 A 2P+E	1300	5
5554 18	380/415 V \sim , 32 A 3P+E	1388	5
5554 19	380/415 V \sim , 32 A 3P+N+E	1476	5

Straight plugs

5553 24	200/250 V \sim , 16 A 2P+E	824	5
5553 28	380/415 V \sim , 16 A 3P+E	902	5
5553 29	380/415 V \sim , 16 A 3P+N+E	960	5
5554 34	200/250 V \sim , 32 A 2P+E	1114	5
5554 38	380/415 V \sim , 32 A 3P+E	1172	5
5554 39	380/415 V \sim , 32 A 3P+N+E	1242	5

P17 Tempra Pro IP 66/67 LV 32 A for refrigerated containers

Combined unit, plug and mobile socket for refrigerated containers

6571 06	Combined unit with interlocked switched socket - Double mechanical interlock - Cable glands are not supplied	16714	1
---------	--------------------------------------------------------------------------------------------------------------	-------	---

Bold Cat.Nos are products normally available with Legrand (India) Stockists. Cat.Nos that are not bold - delivery within 4 - 8 weeks from the date of order. Bold packing quantity is our mandatory packing. Orders to be placed by Legrand (India) Stockist in multiples of the same.



5552 58



5551 88



5551 08



5551 28



5553 28



6571 06

P17 Tempra Pro IP 66/67 LV 32 A for refrigerated containers

Cat.Nos	Polarity	MRP* ₹ / Unit	Pack
---------	----------	------------------	------

Combined unit, plug and mobile socket for refrigerated containers

5554 91	Panel mounting socket	1328	5
5554 21	Mobile socket with cable grip Ø12 to 21.5 mm	1610	5
5554 41	Straight plug With cable grip Ø12 to 21.5 mm	1346	5

P17 Tempra Pro IP 66/67 - LV 63 and 125 A

Surface mounting sockets

5555 54	200/250 V~, 63 A 2P+E	4376	2
5555 58	380/415 V~, 63 A 3P+E	4572	2
5555 59	380/415 V~, 63 A 3P+N+E	4832	2
5556 58	380/415 V~, 125 A 3P+E	12676	2
5556 59	380/415 V~, 125 A 3P+N+E	13436	2

Panel mounting sockets

5555 84	200/250 V~, 63 A 2P+E	3470	2
5555 88	380/415 V~, 63 A 3P+E	3540	2
5555 89	380/415 V~, 63 A 3P+N+E	3728	2
5556 88	380/415 V~, 125 A 3P+E	10018	1
5556 89	380/415 V~, 125 A 3P+N+E	10710	1

Straight plugs

5555 24	200/250 V~, 63 A 2P+E	2940	2
5555 28	380/415 V~, 63 A 3P+E	2984	2
5555 29	380/415 V~, 63 A 3P+N+E	3272	2
5556 28	380/415 V~, 125 A 3P+E	8886	1
5556 29	380/415 V~, 125 A 3P+N+E	9420	1

Mobile sockets

5555 04	200/250 V~, 63 A 2P+E	3750	2
5555 08	380/415 V~, 63 A 3P+E	3896	2
5555 09	380/415 V~, 63 A 3P+N+E	4134	2
5556 08	380/415 V~, 125 A 3P+E	12934	1
5556 09	380/415 V~, 125 A 3P+N+E	13710	1

Plugs and sockets

Cat.Nos	Polarity	MRP* ₹ / Unit	Pack
---------	----------	------------------	------

P17 combined unit to be equipped

Bases with mechanical super-compact sockets

0573 00	16 A, 2P+E IP 44 Interlock	4418	1
0573 02	16 A, 3P+N+E IP 44 Interlock	4876	1
0573 20	16 A, 2P+E IP 55 Interlock	4958	1
0573 22	16 A, 3P+N+E IP 55 Interlock	5578	1
0577 23	Mounting plate for 2 super-compact mechanical interlock sockets	2480	1

Bases for 125 x 220 mm face plates

Example of combined unit configuration

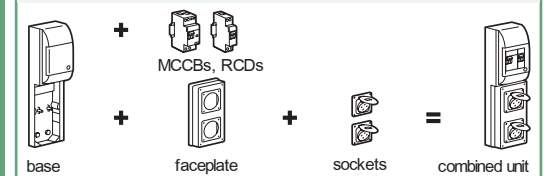

0577 10	Surface mounting box - upto 2 sockets	1034	2
0589 38	Surface mounting box with 5 module dinrail - upto 2 sockets	2890	1
0577 05	Surface mounting box with 12 module dinrail - upto 4 sockets	6380	1
0577 06	Surface mounting box with 18 module dinrail - upto 6 sockets	8930	1

Face plates 125 x 220 mm without sockets

0577 12	For 1 x 16 A or 32 - upto A socket	980	5
0577 13	For 2 x 16 A - upto sockets	1232	5
0577 17	For 1 x 63 A - upto sockets	1130	5
0577 15	Blanking Plate	832	5

Bases for 125 x 280 mm faceplates

0577 11	Surface mounting box - upto 3 sockets	1076	3
0577 20	Surface mounting box with 5 module dinrail - upto 3 sockets	3098	1
0577 03	Surface mounting box with 12 module dinrail - upto 6 sockets	6614	1
0577 04	Surface mounting box with 18 module dinrail - upto 9 sockets	9200	1

* MRP - Maximum Retail Price Inclusive of all taxes including GST.

Bold Cat.Nos are products normally available with Legrand (India) Stockists. Cat.Nos that are not bold - delivery within 4 - 8 weeks from the date of order. Bold packing quantity is our mandatory packing. Orders to be placed by Legrand (India) Stockist in multiples of the same.

Plugs and sockets

Cat.Nos	Polarity	MRP* ₹ / Unit	Pack
---------	----------	------------------	------

Face plates 125 x 280 mm without sockets

0577 18	For 2 x 16 A and / or 32 A sockets	1538	4
0577 19	For 1 x 16 A or 32 A socket and 1 x 63 A socket	1446	2
0577 14	For 3 x 16 A sockets	1754	4
0577 16	Blanking plate	976	4

Hypra industrial plugs and sockets

Sockets

Prisinter panel mounting sockets - IP 44, IK 09

0520 02	230 V, 16 A, 2P+E	9868	1/10
0527 02	230 V, 32 A, 2P+E	10658	1/6
0529 03	415 V, 32 A, 3P+E	10924	1/6
0529 04	415 V, 32 A, 3P+N+E	12980	1/6
0536 04	415 V, 63 A, 3P+N+E	41594	1

Panel mounting sockets - inclined IP 44, IK 09

0522 23	415 V, 16 A, 3P+E	1588	5/50
0538 23	415 V, 63 A, 3P+E	4964	1

Mobile sockets - IP 44, IK 09

0522 83	415 V, 16 A, 3P+E	3802	5/50
---------	-------------------	------	------

Plugs

Straight plugs - IP 44, IK 09

0520 42	250 V, 16 A, 2P+E	1628	5/50
0527 42	250 V, 32 A, 2P+E	2140	1/5
0522 43	415 V, 16 A, 3P+E	2826	5/50
0529 43	415 V, 32 A, 3P+E	2686	5/50
0529 44	415 V, 32 A, 3P+N+E	2976	5/15
0538 43	415 V, 63 A, 3P+E	7102	1/5
0538 44	415 V, 63 A, 3P+N+E	9542	1/5

Metra plugs and sockets

Plugs

Ivory

6500 22	240 V, 10 A, 2P+E	174	1/5/100
6500 28	240 V, 20 A, 2P+E	184	1/5/100

Grey

6500 02	240 V, 10 A, 2P+E	174	1/5/100
6500 08	240 V, 20 A, 2P+E	184	1/5/100
6500 10	440 V, 20 A, 3P+E	246	1/5/100
6500 16	440 V, 32 A, 3P+E	460	1/5/100

Sockets

6500 03	240 V, 10 A, 2P+E With blue cap	178	1/5/100
6500 23	240 V, 10 A, 2P+E With ivory cap	178	1/5/100

* MRP - Maximum Retail Price Inclusive of all taxes including GST.

Hypra industrial plugs and sockets

Cat.Nos	Description	MRP* ₹ / Unit	Pack
---------	-------------	------------------	------

Sockets

6500 09	240 V, 20 A, 2P+E With blue cap	204	1/5/100
6500 29	240 V, 20 A, 2P+E With ivory cap	204	1/5/100
6500 11	440 V, 20 A, 3P+E With red cap	274	1/5/100
6500 17	440 V, 32 A, 3P+E With red cap	460	1/5/100

Plugs and sockets

P17 tempra combined units

With interlocked switched sockets and surface mounting box IP 44

0566 01	250 V, 16 A, 2P+E	6634	1
0566 09	250 V, 32 A, 2P+E	7916	1
0566 13	415 V, 32 A, 3P+E	9574	1
0566 14	415 V, 32 A, 3P+N+E	10050	1

With interlocked switched sockets and surface mounting box IP 55

0566 21	250 V, 16 A, 2P+E	7370	1
0566 29	250 V, 32 A, 2P+E	8422	1
0566 33	415 V, 32 A, 3P+E	10676	1
0566 34	415 V, 32 A, 3P+N+E	10870	1

With interlocked switched sockets and surface mounting box IP 44 with DIN rail for 5 module DX³ protection

0566 41	250 V, 16 A, 2P+E	7078	1
0566 49	250 V, 32 A, 2P+E	8610	1
0566 53	415 V, 32 A, 3P+E	9522	1
0566 54	415 V, 32 A, 3P+N+E	10188	1

With interlocked switched sockets and surface mounting box IP 66 with DIN rail for 5 module DX³ protection

0566 61	250 V, 16 A, 2P+E	7930	1
0566 69	250 V, 32 A, 2P+E	9202	1
0566 73	415 V, 32 A, 3P+E	9934	1
0566 74	415 V, 32 A, 3P+N+E	10738	1

With interlocked switched sockets and without surface mounting box IP 55

0572 21	250 V, 16 A, 2P+E	6380	1
0572 29	250 V, 32 A, 2P+E	7214	1
0572 33	415 V, 32 A, 3P+E	8566	1
0572 34	415 V, 32 A, 3P+N+E	9356	1
0572 95	415 V, 63 A, 3P+N+E, IP 66	26288	1
0577 00	Base box for 0572 95	3642	1

P17 tempra combined units

with interlocked switched sockets IP 66

0589 18	380 to 415 V, 50/60 Hz, 63 A, 3P + E with provision for 5 module DX ³ protection	29862	1
0572 99	380 to 415 V, 50/60 Hz, 63 A, 3P+N+E with provision for 5 module DX ³ protection	31548	1

Bold Cat.Nos are products normally available with Legrand (India) Stockists. Cat.Nos that are not bold - delivery within 4 - 8 weeks from the date of order. Bold packing quantity is our mandatory packing. Orders to be placed by Legrand (India) Stockist in multiples of the same.

Warranty policy

Legrand warrants to the original purchaser that the Products (excluding any third party products purchased through Legrand, for which no warranties are made) will be free from defects in material and workmanship, under normal use and regular service, and preventative maintenance for a period of 18 months from the date of shipment or 12 months from the date of installation whichever is earlier. Should any failure to conform with this warranty be found during the Warranty Period, you must notify Legrand of your claim within thirty (30) days of discovery, and within the Warranty Period. Your failure to give notice of claims of breach of warranty within the Warranty Period shall be deemed an absolute and unconditional waiver of claims for such defects. Legrand will have no responsibility to honour claims received after the date the applicable Warranty Period expires. The invoice / bill in original must be produced without which warranty claim shall not be entertained.

This warranty does not cover the following:

- Defect caused due to misuse, alteration, faulty installation, faulty electrical systems, negligent maintenance or misapplication of the product.
- Failure of product or components due to any act of nature; lightning strike, floods, hurricanes, tornadoes, etc. beyond the control of human being.
- Legrand does not warrant any third party products or associated hardware or their performance or suitability for use and application. Such items are provided "as-is".

Extended warranty policy is applicable for following products,

1. DX³ & RX³ MCB – 5 years if mounted inside Legrand DB
2. Arteor™, Myrius™, Mylinc™, Britzy™ switches (without neon lamp) & Power sockets – 10 years
3. Arteor™, Myrius™, Mylinc™, Britzy™ other products – 2 years

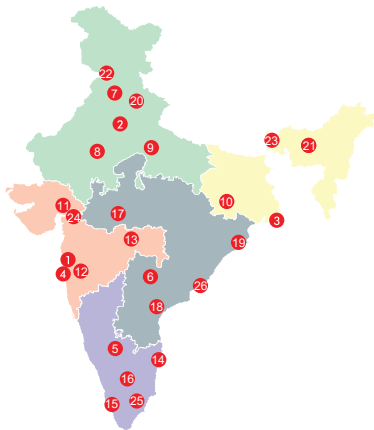

Head offices

- 61 & 62, 6th Floor,
Kalpataru Square, Kondivita Road,
Off Andheri-Kurla Road, Andheri (E),
MUMBAI – 400 059.
Tel : (022) 3041 6200
Fax : (022) 3041 6201
Website : www.legrand.co.in

Regional sales offices

- A-25, Mohan Co-operative
Industrial Estate, Mathura Road,
NEW DELHI – 110 044.
Tel : (011) 3990 2200, 2699 0046,
(011) 2699 0028 / 29 / 30 / 31
Fax : (011) 2699 0047
- Bhakta Towers, 2nd & 3rd Floor,
Plot No. KB 22, Sector-III, Saltlake,
KOLKATA – 700 098.
Tel : (033) 4021 3535 / 36
Fax : (033) 4021 3537
- C/203, Corporate Avenue, Atul Projects,
Near Mirador Hotel, Chakala,
Andheri Ghatkopar Link Road,
Andheri – East, **MUMBAI** – 400 099.
Tel : (022) 3385 6200 / 62301000
- Ferozes Manor,
Situated at 58 Hospital Road,
Shivaji Nagar,
BANGALORE – 560 001.
Tel : (080) 6822 0000
- 205-208, 2nd Floor, Block - II,
White House, Kundan Bagh,
Begumpet,
HYDER ABAD – 500 016.
Tel : (040) 2341 4398 / 67, 4567 1717
Fax : (040) 4567 1730

Branch offices

- Unit 203, 2nd Floor, Tower- B,
Bestech Business Tower, Sector 66,
Mohali, **CHANDIGARH**-160066.
Telefax : (0141) 2208665, 666
- 507-510, 5th Floor, Soni Paris Point,
Jai Singh Highway, Banipark,
JAIPUR- 302 016.
Tel / Fax : (0141) 220 8665 / 666
- 209-A, 2nd Floor, Cyber Heights,
Opp. Indira Gandhi Pratishthan,
Vibhuti Khand, Gomti Nagar
LUCKNOW- 226 010.
Tel : (522) 319 2031 / 32 / 33
- 202 & 203, 2nd Floor, Sunrise,
Forum 100, Burdwan Compound, Lalpur,
RANCHI – 834 001.
Tel : (651) 660 5400
- A 101-102, Mondeal Heights,
Besides Novotel Hotel, Sarkhej
Gandhinagar Highway (S G Highway),
AHMEDABAD – 380 015.
Tel : (079) 6134 0555
- 402, Swastik Chambers,
Near Ashwamegh Marriage Hall,
Behind HP Petrol Pump,
Off Karve Road, Erandwane,
PUNE – 411 004.
Tel : (020) 6729 5601 / 602
Fax : (020) 6729 5604
- Plot No.95, II Floor, Shreyash Heights,
VIP Road, Ramdaspath,
NAGPUR – 440 010.
Tel : (0712) 662 7857 / 858
Fax : (0712) 662 7859
- 10 B, (10th Floor), Prestige Center Court
Office Block Vijaya Forum Mall, #183,
N.S.K. Salai, Vadapalani
CHENNAI – 600 026.
Tel : (044) 6612 2800 / 2362 3125 / 35 / 45
Fax : (044) 2362 3165
- J. B. Manjooran Estate,
Door No 50/1107A9, 3rd Floor,
Bye Pass Junction, Edappally,
COCHIN – 682 024.
Tel : (0484) 280 1921 / 2921, 658 0921
Fax : (0484) 280 1921 / 2921
- B-5, 1st Floor, Thirumalai Towers,
723, Avanashi Road,
COIMBATORE – 641 018.
Tel : (0422) 222 3634 / 0283
Fax : (0422) 222 3164
- 204-205, Megapolis Square,
579, M G Road,
INDORE – 452 001.
Tel : (0731) 4999 891 / 892

- MF-2, Datta's Lords House,
Jamma Chettu Street, Mogalrajapuram,
VIJAYAWADA – 520 010.
Tel : (0866) 248 2393/6393/5393
- Plot No. 359, Saheed Nagar,
2nd Floor,
BHUBANESWAR – 751 007.
Tel : (0674) 254 0623
- Unit - 1 & 2, Vijay Park,
Main Chakrata Road,
DEHRADUN- 248 001.
Uttarakhand.
Tel : (0135) 661 6100
- House No. 97, Ground Floor,
Rajgarh Main Road,
Opp. City Heart Nursing Home,
GUWAHATI – 781 007.
Tel : (0361) 245 8498

Area offices

- Cabin No. 9, Second Floor,
Madhok Trade Centre,
Madhok Complex, Ferozpur Road,
LUDHIANA – 141 001.
Tel : (0161) 277 0301 / 2 / 3 / 4
- 94, Udham Singh Sarani,
Ground Floor, Ashrampara,
SILIGURI – 734 001.
Tel : (0353) 264 1067
- 405, City Centre, Sosyo Circle,
Udhana Magdalla Road,
SURAT - 395 002.
Tel : (0261) 263 3861
- Aparna Towers, 1st Floor, 2/3,
Bypass Road,
MADURAI – 625 010.
Telefax : (0452) 230 8414
- 43-9-205, Near srikanya theatre
3rd floor, Plot No 10, Subbalaskhmi
Nagar, Allipuram Ward,
Dondapar thy Area,
VISHAKAPATHANAM - 530 016.
Tel : (0891) 663 5652 / 663 9363

Technical assistance from Legrand

Telephonic technical assistance for selection of products, technical information, guidance, wiring diagrams and estimation is now made available to you at each Regional Office. Contact the Technical Officer of Legrand at the following telephone numbers

- New Delhi** : Tel.: (011) 2699 0028, 3990 2200
Kolkata : Tel.: (033) 4021 3535 / 36
Mumbai : Tel.: (022) 3385 6200
Chennai : Tel.: (044) 3024 7200
Hyderabad : Tel.: (040) 2341 4398 / 67, 4567 1717

For other places, contact the nearest
Regional / Branch / Area offices

customer.care@legrand.co.in

