

# RETAIL PRICE LIST

EFFECTIVE NOV 2020

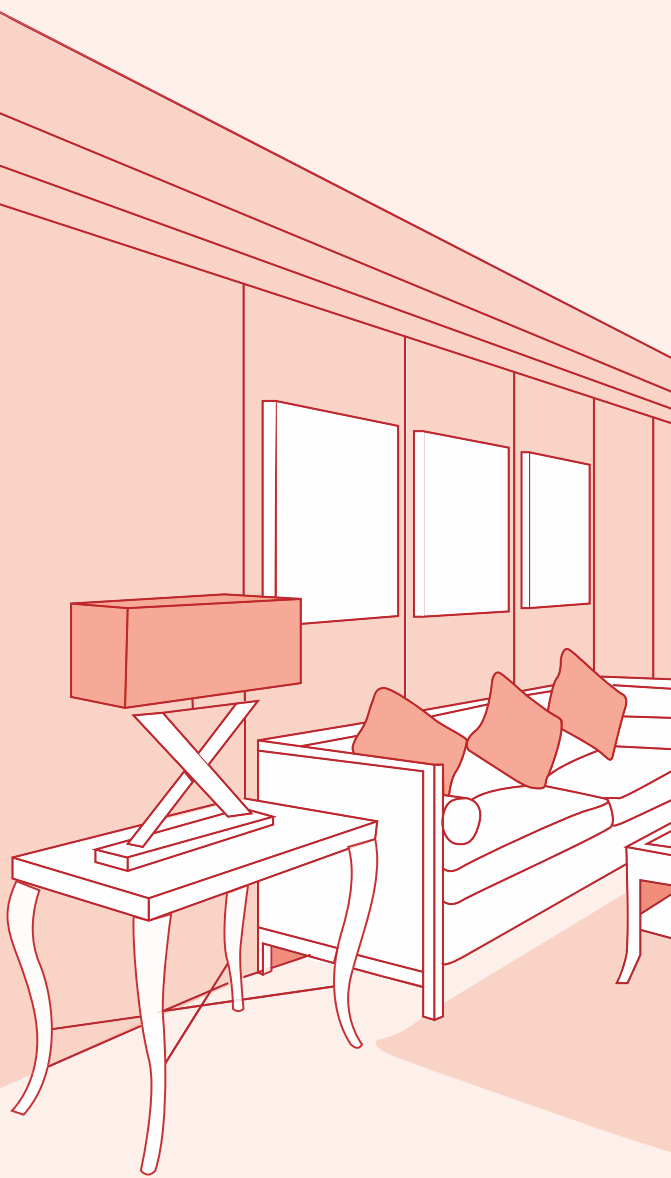



**Caretron™ MINIATURE CIRCUIT BREAKER - MCB**

- ISI / CE Marked as per IS/IEC 60898 -1 • Degree of Protection IP 20 • 25 sq. mm Terminals • Breaking Capacity 6kA
- Bi-Connect Terminals • Positive Isolation • Frequency 50Hz • Operating Voltage 240V / 415V AC, 60V DC per Pole

**B CURVE SINGLE POLE**

HSN Code: 8536

	Rating (A)	Pack	Cat. Nos.	Unit Price (₹)
	6	1/12/180	810000	186
	10	1/12/180	810001	186
	16	1/12/180	810002	186
	20	1/12/180	810003	186
	25	1/12/180	810004	186
	32	1/12/180	810005	186
	40	1/12/180	810006	376
	50	1/12/180	810007	440
63	1/12/180	810008	440	

**B CURVE SINGLE POLE NEUTRAL**

HSN Code: 8536

	Rating (A)	Pack	Cat. Nos.	Unit Price (₹)
	6	1/6/90	810009	604
	10	1/6/90	810010	604
	16	1/6/90	810011	604
	20	1/6/90	810012	604
	25	1/6/90	810013	604
	32	1/6/90	810014	604
	40	1/6/90	810015	826
	50	1/6/90	810016	898
63	1/6/90	810017	898	

**B CURVE DOUBLE POLE**

HSN Code: 8536

	Rating (A)	Pack	Cat. Nos.	Unit Price (₹)
	6	1/6/90	810018	626
	10	1/6/90	810019	626
	16	1/6/90	810020	626
	20	1/6/90	810021	626
	25	1/6/90	810022	626
	32	1/6/90	810023	626
	40	1/6/90	810024	890
	50	1/6/90	810025	1012
63	1/6/90	810026	1012	

**C CURVE SINGLE POLE**

HSN Code: 8536

	Rating (A)	Pack	Cat. Nos.	Unit Price (₹)
	6	1/12/180	810054	188
	10	1/12/180	810055	188
	16	1/12/180	810056	188
	20	1/12/180	810057	188
	25	1/12/180	810058	188
	32	1/12/180	810059	188
	40	1/12/180	810060	404
	50	1/12/180	810061	502
63	1/12/180	810062	502	

**Caretron™ MINIATURE CIRCUIT BREAKER - MCB**

- ISI / CE Marked as per IS/IEC 60898 -1 • Degree of Protection IP 20 • 25 sq. mm Terminals • Breaking Capacity 6kA
- Bi-Connect Terminals • Positive Isolation • Frequency 50Hz • Operating Voltage 240V / 415V AC, 60V DC per Pole

**C CURVE SINGLE POLE NEUTRAL**

HSN Code: 8536

	Rating (A)	Pack	Cat. Nos.	Unit Price (₹)
	6	1/6/90	810063	618
10	1/6/90	810064	618	
16	1/6/90	810065	618	
20	1/6/90	810066	618	
25	1/6/90	810067	618	
32	1/6/90	810068	618	
40	1/6/90	810069	858	
50	1/6/90	810070	1016	
63	1/6/90	810071	1016	

**C CURVE DOUBLE POLE**

HSN Code: 8536

	Rating (A)	Pack	Cat. Nos.	Unit Price (₹)
	6	1/6/90	810072	650
10	1/6/90	810073	650	
16	1/6/90	810074	650	
20	1/6/90	810075	650	
25	1/6/90	810076	650	
32	1/6/90	810077	650	
40	1/6/90	810078	912	
50	1/6/90	810079	1088	
63	1/6/90	810080	1088	

**C CURVE THREE POLE**

HSN Code: 8536

	Rating (A)	Pack	Cat. Nos.	Unit Price (₹)
	6	1/4/60	810081	1052
10	1/4/60	810082	1052	
16	1/4/60	810083	1052	
20	1/4/60	810084	1052	
25	1/4/60	810085	1052	
32	1/4/60	810086	1052	
40	1/4/60	810087	1448	
50	1/4/60	810088	1630	
63	1/4/60	810089	1630	

**C CURVE THREE POLE NEUTRAL**

HSN Code: 8536

	Rating (A)	Pack	Cat. Nos.	Unit Price (₹)
	6	1/3/45	810090	1384
10	1/3/45	810091	1384	
16	1/3/45	810092	1384	
20	1/3/45	810093	1384	
25	1/3/45	810094	1384	
32	1/3/45	810095	1384	
40	1/3/45	810096	1794	
50	1/3/45	810097	1904	
63	1/3/45	810098	1904	

**Caretron™ MINIATURE CIRCUIT BREAKER - MCB**

**C CURVE FOUR POLE**

**HSN Code: 8536**

	Rating (A)	Pack	Cat. Nos.	Unit Price (₹)
	6	1/3/45	810099	1400
10	1/3/45	810100	1400	
16	1/3/45	810101	1400	
20	1/3/45	810102	1400	
25	1/3/45	810103	1400	
32	1/3/45	810104	1400	
40	1/3/45	810105	1840	
50	1/3/45	810106	2076	
63	1/3/45	810107	2076	

**Caretron™ ISOLATOR**

- Conforms to IEC 60947-3 • Bi-Connect Terminals • Positive Isolation
- Degree of Protection IP 20 • 25 sq. mm Terminals

**DOUBLE POLE**

**HSN Code: 8536**

	Rating (A)	Pack	Cat. Nos.	Unit Price (₹)
	40	1/6/90	810130	428
63	1/6/90	810131	534	

**THREE POLE**

**HSN Code: 8536**

	Rating (A)	Pack	Cat. Nos.	Unit Price (₹)
	40	1/4/60	810132	804
63	1/4/60	810133	904	

**FOUR POLE**

**HSN Code: 8536**

	Rating (A)	Pack	Cat. Nos.	Unit Price (₹)
	40	1/3/45	810134	960
63	1/3/45	810135	1008	

**Caretron™ RESIDUAL CURRENT CIRCUIT BREAKER - RCCB**

- ISI / CE Marked as per IS/IEC 12640 -1 • Rated Conditional Short Circuit Current, Inc 6kA
- Degree of Protection IP 20 • Bi-Connect Terminals • 25 sq. mm Terminals

**DOUBLE POLE**

**HSN Code: 8536**

	Rating (A)	Sensitivity	Pack	Cat. Nos.	Unit Price (₹)
	25	30 mA	1/6/90	810150	2394
25	100 mA	1/6/90	810153	2444	
25	300 mA	1/6/90	810156	2444	
40	30 mA	1/6/90	810151	2636	
40	100 mA	1/6/90	810154	2660	
40	300 mA	1/6/90	810157	2660	
63	30 mA	1/6/90	810152	3346	
63	100 mA	1/6/90	810155	3376	
63	300 mA	1/6/90	810158	3376	

**FOUR POLE**

**HSN Code: 8536**

	Rating (A)	Sensitivity	Pack	Cat. Nos.	Unit Price (₹)
	25	30 mA	1/3/45	810159	3072
25	100 mA	1/3/45	810162	3110	
25	300 mA	1/3/45	810165	3110	
40	30 mA	1/3/45	810160	3122	
40	100 mA	1/3/45	810163	3160	
40	300 mA	1/3/45	810166	3160	
63	30 mA	1/3/45	810161	3550	
63	100 mA	1/3/45	810164	3602	
63	300 mA	1/3/45	810167	3602	

—optipro— **MINIATURE CIRCUIT BREAKER - MCB**

- ISI / CE Marked as per IS/IEC 60898 - 1 • Rated Short-Circuit Breaking Capacity, Icn 10kA • Degree of Protection IP 20
- Energy Limitation Class 3 • Line Load Reversibility • 35 sq. mm Terminals • Biconnect Terminals • Frequency: 50 Hz
- Operating Voltage : 240V / 415V AC , 60V DC per pole

**B CURVE SINGLE POLE**

HSN Code: 8536

	Rating (A)	Pack	Cat. Nos.	Unit Price (₹)
	6	1/12/180	811008	228
10	1/12/180	811010	228	
16	1/12/180	811012	228	
20	1/12/180	811013	228	
25	1/12/180	811014	228	
32	1/12/180	811015	228	
40	1/12/180	811016	514	
50	1/12/180	811017	600	
63	1/12/180	811018	600	

**B CURVE SINGLE POLE NEUTRAL**

HSN Code: 8536

	Rating (A)	Pack	Cat. Nos.	Unit Price (₹)
	6	1/6/90	811027	728
10	1/6/90	811029	728	
16	1/6/90	811031	728	
20	1/6/90	811032	728	
25	1/6/90	811033	728	
32	1/6/90	811034	728	
40	1/6/90	811035	1006	
50	1/6/90	811036	1148	
63	1/6/90	811037	1148	

**B CURVE DOUBLE POLE**

HSN Code: 8536

	Rating (A)	Pack	Cat. Nos.	Unit Price (₹)
	6	1/6/90	811046	762
10	1/6/90	811048	762	
16	1/6/90	811050	762	
20	1/6/90	811051	762	
25	1/6/90	811052	762	
32	1/6/90	811053	762	
40	1/6/90	811054	1098	
50	1/6/90	811055	1222	
63	1/6/90	811056	1222	

—optipro— **ISOLATOR**

- Conforms to IEC 60947-3 • CE Marked • Degree of Protection IP 20 • 35 sq. mm Terminals • Biconnect Terminals
- Frequency: 50 Hz • Operating Voltage: 240V/415V AC, 60V DC per Pole

**DOUBLE POLE**

HSN Code: 8536

	Rating (A)	Pack	Cat. Nos.	Unit Price (₹)
	80	1/6/90	811552	748
100	1/6/90	811553	748	
125	1/6/90	811554	808	

**THREE POLE**

HSN Code: 8536

	Rating (A)	Pack	Cat. Nos.	Unit Price (₹)
	80	1/4/60	811557	1134
100	1/4/60	811558	1134	
125	1/4/60	811559	1242	

**FOUR POLE**

HSN Code: 8536

	Rating (A)	Pack	Cat. Nos.	Unit Price (₹)
	80	1/3/45	811562	1408
100	1/3/45	811563	1408	
125	1/3/45	811564	1522	

**AUTOMATIC CHANGEOVER WITH CURRENT LIMITER**

- Conforms to IEC 60947-6-1
- Intelligent micro controller based Design
- RoHS Compliant

**HSN Code: 8536**

**NEW**

	Rating (A)	Pack	Cat. Nos.	Unit Price (₹)
	SPN 30A Mains 1.5A DG ACCL	1/3/45	810409	1656
	SPN 30A Mains 2.5A DG ACCL	1/3/45	810410	1656
	SPN 30A Mains 3A DG ACCL	1/3/45	810400	1656
	SPN 30A Mains 4A DG ACCL	1/3/45	810401	1656
	SPN 30A Mains 5A DG ACCL	1/3/45	810402	1656
	SPN 30A Mains 6A DG ACCL	1/3/45	810403	1656
	SPN 30A Mains 9A DG ACCL	1/3/45	810404	1656
	SPN 30A Mains 12A DG ACCL	1/3/45	810405	1656
	SPN 30A Mains 15A DG ACCL	1/3/45	810406	1656
	SPN 30A Mains 20A DG ACCL	1/3/45	810407	1656
	SPN 30A Mains 30A DG ACCL	1/3/45	810408	1656

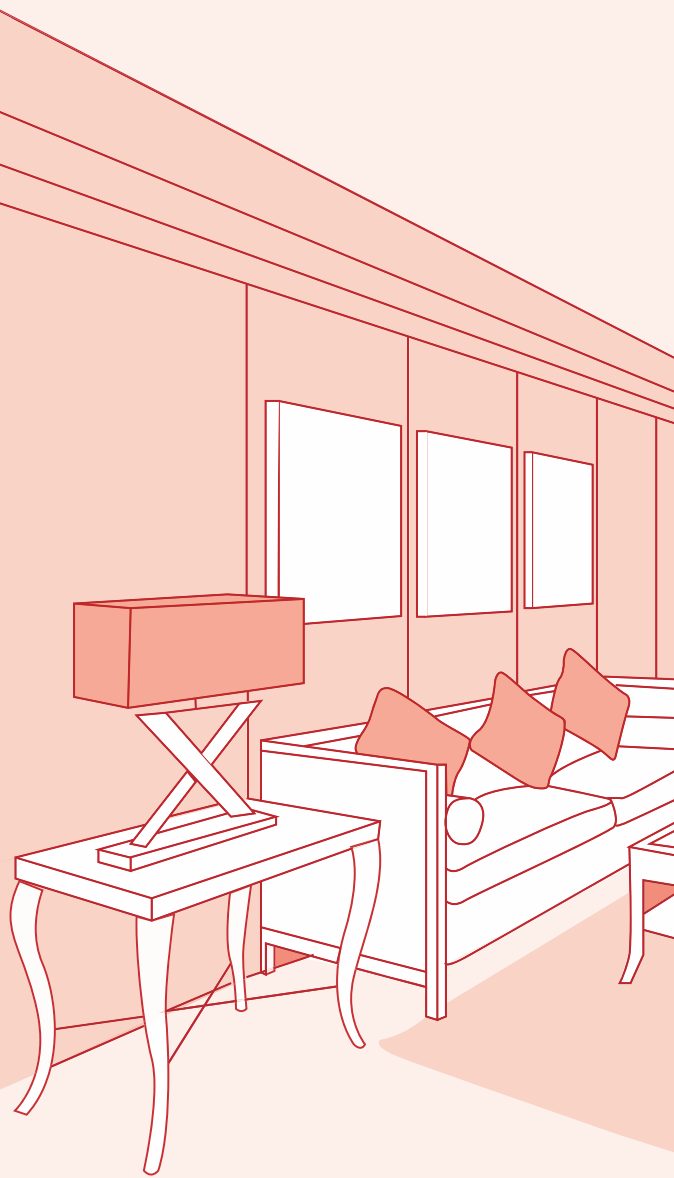

## RELIABILITY. SAFETY. ALL-ROUND ELECTRICAL PROTECTION



Innovative design



Detachable Gland Plate



Degree of protection IP30 and IP42

**Caretron**<sup>™</sup>  
Made for India



**Caretron™ DISTRIBUTION BOARDS**

- Innovative Design • Degree of Protection IP 30 & IP 42 • Detachable Gland Plate • Attractive Pearl Shade
- Box Insertion Marks • Circuit Identification Label • Neutral Link • Earth Link • Tin Plated Copper Bus Bar

**SPN SINGLE DOOR**

**HSN Code: 8537**

	No. of Way	Incomer+ Outgoing	Pack	Cat. Nos.	Unit Price (₹)
	4	4	1/19	810311	702
	6	6	1/18	810312	774
	8	8	1/13	810313	880
	12	12	1/11	810315	1200
	16	16	1/9	810316	1468

**SPN DOUBLE DOOR**

**HSN Code: 8537**

	No. of Way	Incomer+ Outgoing	Pack	Cat. Nos.	Unit Price (₹)
	4	4	1/14	810319	1150
	6	6	1/12	810320	1284
	8	8	1/10	810321	1428
	12	12	1/9	810323	1768
	16	16	1/7	810324	2142

**HSN Code: 8537**

**SPN ACRYLIC**

	No. of Way	Incomer+ Outgoing	Pack	Cat. Nos.	Unit Price (₹)
	4	4	1/12	810345	786
	6	6	1/12	810346	906
	8	8	1/8	810347	1066
	10	10	1/8	810348	1182
	12	12	1/8	810349	1312
	16	16	1/6	810350	2028

**TPN SINGLE DOOR**

**HSN Code: 8537**

	No. of Way	Incomer+ Outgoing	Pack	Cat. Nos.	Unit Price (₹)
	4	4 + 12	1/8	810327	2024
	4	8 + 12	1/8	810328	2164
	6	4 + 18	1/5	810329	2432
	6	8 + 18	1/5	810330	2706
	8	8 + 24	1/4	810331	3246
	12	8 + 36	1/4	810332	4376

**TPN DOUBLE DOOR**

**HSN Code: 8537**

	No. of Way	Incomer+ Outgoing	Pack	Cat. Nos.	Unit Price (₹)
	4	4 + 12	1/6	810336	2710
	4	8 + 12	1/6	810337	2812
	6	4 + 18	1/4	810338	3150
	6	8 + 18	1/4	810339	3360
	8	8 + 24	1/3	810340	4146
	12	8 + 36	1/3	810341	4694

**Caretron™ DISTRIBUTION BOARDS**

- Innovative Design • Degree of Protection IP 30 & IP 42 • Detachable Gland Plate • Attractive Pearl Shade
- Box Insertion Marks • Circuit Identification Label • Neutral Link • Earth Link • Tin Plated Copper Bus Bar

**VTPN MCB INCOMER SINGLE DOOR**

**HSN Code: 8537**

	No. of Way	Incomer+ Outgoing	Pack	Cat. Nos.	Unit Price (₹)
	4	8 + 12	1	810353	5458
	6	8 + 18	1	810354	6590
	8	8 + 24	1	810355	7534
	12	8 + 36	1	810356	8652

**VTPN MCB INCOMER DOUBLE DOOR**

**HSN Code: 8537**

	No. of Way	Incomer+ Outgoing	Pack	Cat. Nos.	Unit Price (₹)
	4	8 + 12	1	810359	7166
	6	8 + 18	1	810360	8396
	8	8 + 24	1	810361	9352
	12	8 + 36	1	810362	12362

**VTPN 125A MCCB I/C DD DB**

**HSN Code: 8537**

	No. of Way	Incomer+ Outgoing	Pack	Cat. Nos.	Unit Price (₹)
	4	Optium F1 + 12	1	810436	7860
	6	Optium F1 + 18	1	810437	8632
	8	Optium F1 + 24	1	810438	9080
	12	Optium F1 + 36	1	810439	11378

**VTPN 250A MCCB I/C DD DB**

**HSN Code: 8537**

	No. of Way	Incomer+ Outgoing	Pack	Cat. Nos.	Unit Price (₹)
	4	Optium F2 + 12	1	810446	9824
	6	Optium F2 + 18	1	810447	10796
	8	Optium F2 + 24	1	810448	11352
	12	Optium F2 + 36	1	810449	14226

**PHASE SELECTOR BARE SINGLE DOOR**

**HSN Code: 8537**

	No. of Way	Incomer+ Outgoing	Pack	Cat. Nos.	Unit Price (₹)
	4	8 + 12	1	810365	5068
	6	8 + 18	1	810366	5556
	8	8 + 24	1	810367	5644
	12	8 + 36	1	810368	7384

**PHASE SELECTOR BARE DOUBLE DOOR**

**HSN Code: 8537**

	No. of Way	Incomer+ Outgoing	Pack	Cat. Nos.	Unit Price (₹)
	4	8 + 12	1	810371	6210
	6	8 + 18	1	810372	6532
	8	8 + 24	1	810373	6976
	12	8 + 36	1	810374	7800

**PHASE SELECTOR 40A DOUBLE DOOR (PRE FITTED SELECTOR SWITCHES)**

**HSN Code: 8536**

	No. of Way	Incomer+ Outgoing	Pack	Cat. Nos.	Unit Price (₹)
	4	8 + 12	1	810375	7806
	6	8 + 18	1	810376	8484
	8	8 + 24	1	810377	8898
	12	8 + 36	1	810378	10172

**PHASE SELECTOR 63A DOUBLE DOOR (PRE FITTED SELECTOR SWITCHES)**

**HSN Code: 8536**

	No. of Way	Incomer+ Outgoing	Pack	Cat. Nos.	Unit Price (₹)
	4	8 + 12	1	810379	9296
	6	8 + 18	1	810380	10080
	8	8 + 24	1	810381	10528
	12	8 + 36	1	810382	11890

**PLUG & SOCKET BOX**

**HSN Code: 8536**

	No. of Way	Incomer+ Outgoing	Pack	Cat. Nos.	Unit Price (₹)
	20A SP (with 20A SP 'C' MCB)	1	1/24	810393	860
	20A DP (with 20A DP 'C' MCB)	2	1/24	810394	1208
	20A TP	3	1/8	810309	1834
	32A TP	3	1/8	810310	2554

**METAL ENCLOSURE**

**HSN Code: 8537**

	No. of Way	Incomer+ Outgoing	Pack	Cat. Nos.	Unit Price (₹)
	1	1	1/60	810302	310
	2	2	1/36	810303	310
	3	3	1/36	810304	360
	4	4	1/32	810305	360

**PLASTIC ENCLOSURE**

**HSN Code: 8536**

	No. of Way	Incomer+ Outgoing	Pack	Cat. Nos.	Unit Price (₹)
	1 & 2	1/2	1/5/45	810300	158
	3 & 4	3/4	1/3/27	810301	228

**MCCB ENCLOSURE**

**HSN Code: 8537**

	Description	Pack	Cat. Nos.	Unit Price (₹)
	Optipro Enclosure for Frame-1 Optium 3 Pole MCCB	1	811984	1364
	Optipro Enclosure for Frame-1 Optium 4 Pole MCCB	1	811985	1364
	Optipro Enclosure for Frame-2 Optium 3 Pole MCCB	1	811986	2096
	Optipro Enclosure for Frame-2 Optium 4 Pole MCCB	1	811987	2096
	Optipro Enclosure for Frame-3 Optium 3 Pole MCCB	1	811988	2096
	Optipro Enclosure for Frame-3 Optium 4 Pole MCCB	1	811989	2096
	Optipro Enclosure for Frame-4 Optium 3 Pole MCCB	1	811990	5242
	Optipro Enclosure for Frame-4 Optium 4 Pole MCCB	1	811991	5242

**METAL CLAD PLUG & SOCKET  
AC PLUG**

**HSN Code: 8536**

	Rating	Pack	Cat. Nos.	Unit Price (₹)
	10A 2P+E, 230V AC	1/10/100	810385	154
	20A 2P+E, 230V AC	1/10/100	810386	164
	20A 3P+E, 230V / 415V AC	1/10/100	810387	224
	32A 3P+E, 230V / 415V AC	1/10/100	810388	406

**AC SOCKET**

**HSN Code: 8536**

	Rating	Pack	Cat. Nos.	Unit Price (₹)
	10A 2P+E, 230V AC	1/10/100	810389	154
	20A 2P+E, 230V AC	1/10/100	810390	178
	20A 3P+E, 230V / 415V AC	1/10/100	810391	236
	32A 3P+E, 230V / 415V AC	1/10/100	810392	406

**TIME SWITCHES**

**HSN Code: 9107**

	Model Name	Description	Cat Ref.	Unit Price (₹)
	1mod DIN Daily	1P Module, 24 hours program, Programmable every 15 min., backup of 100 hours, current capacity 16A, with 1 changeover (1 CO)	TA916422	3004
	3mod DIN Daily	3P Module, 24 hours program, Programmable every 15 min., backup of 100 hrs., current capacity 16A, with 1 changeover (1 CO)	TA926453	3272
	DIN Type Daily / Weekly with 1 CO	Programmable every 1 min., with backup of 6 years, 28 memory locations, current capacity 16A, weekly program, with 1 changeover (1 CO), Total 28 program	TDA43110	3978

\* For other models of Time Switches please contact nearest Branch Office.



## COMPACT SIZE, SUITABLE FOR ALL ENVIRONMENTS

 Flexible  
16A to 1250A range

 Suitable for  
isolation

 Overload, Short circuit &  
ground fault protection

— **optium**™ —  
ALL THAT YOU NEED

—optium™— **OPTIUM 1.0E (FIXED TM RANGE MCCB)**

- Ics =50% Icu as per IEC 60947-II
- Class II front face
- Suitable for isolation
- Fixed Overload & fixed short circuit setting

**HSN Code: 8536**

Image	Frame	Breaking capacity	Rating	3P	Unit Price (₹)	4P	Unit Price (₹)
		F1	10kA	16	830701	2026	830710
F1		10kA	25	830702	2026	830711	2658
F1		10kA	32	830703	2026	830712	2658
F1		10kA	40	830704	2026	830713	2658
F1		10kA	50	830705	2026	830714	2658
F1		10kA	63	830706	2026	830715	2658
F1		10kA	80	830707	2170	830716	2938
F1		10kA	100	830708	2170	830717	2938
F1		10kA	125	830709	3068	830718	4130

**HSN Code: 8536**

Image	Frame	Breaking capacity	Rating	3P	Unit Price (₹)	4P	Unit Price (₹)
		F1	16kA	16	830001	3568	830015
F1		16kA	25	830002	3568	830016	4440
F1		16kA	32	830003	3568	830017	4440
F1		16kA	40	830004	3568	830018	4440
F1		16kA	50	830005	3568	830019	4440
F1		16kA	63	830006	3568	830020	4440
F1		16kA	80	830007	3672	830021	4822
F1		16kA	100	830008	3672	830022	4822
F1		16kA	125	830009	5392	830023	7470

**HSN Code: 8536**

Image	Frame	Breaking capacity	Rating	3P	Unit Price (₹)	4P	Unit Price (₹)
		F1	25kA	16	830031	4520	830045
F1		25kA	25	830032	4520	830046	5562
F1		25kA	32	830033	4520	830047	5562
F1		25kA	40	830034	4520	830048	5562
F1		25kA	50	830035	4520	830049	5562
F1		25kA	63	830036	4520	830050	5562
F1		25kA	80	830037	4610	830051	5728
F1		25kA	100	830038	4610	830052	5728
F1		25kA	125	830039	5886	830053	7834

**HSN Code: 8536**

Image	Frame	Breaking capacity	Rating	3P	Unit Price (₹)	4P	Unit Price (₹)
		F1	36kA	16	830061	5926	830075
F1		36kA	25	830062	5926	830076	6912
F1		36kA	32	830063	5926	830077	6912
F1		36kA	40	830064	5926	830078	6912
F1		36kA	50	830065	5926	830079	6912
F1		36kA	63	830066	5926	830080	6912
F1		36kA	80	830067	6320	830081	7284
F1		36kA	100	830068	6320	830082	7284
F1		36kA	125	830069	6860	830083	8828

—optium™— **OPTIUM 1.0 (FIXED TM RANGE MCCB)**

**HSN Code: 8536**

	Frame	Breaking capacity	Rating	3P	Unit Price (₹)	4P	Unit Price (₹)
	F3	50kA	16	830125	8208	830145	9978
	F3	50kA	25	830126	8208	830146	9978
	F3	50kA	32	830127	8208	830147	9978
	F3	50kA	40	830128	8208	830148	9978
	F3	50kA	50	830129	8208	830149	9978
	F3	50kA	63	830130	8208	830150	9978
	F3	50kA	80	830131	8452	830151	10078
	F3	50kA	100	830132	8452	830152	10078
	F3	50kA	125	830133	9860	830153	11810

**HSN Code: 8536**

	Frame	Breaking capacity	Rating	3P	Unit Price (₹)	4P	Unit Price (₹)
	F2	16kA	160	830090	5978	830095	8602
	F2	16kA	200	830091	7242	830096	9426
	F2	16kA	250	830092	7990	830097	9956
	F2	25kA	160	830100	7112	830105	9866
	F2	25kA	200	830101	9142	830106	11474
	F2	25kA	250	830102	13416	830107	16658
	F2	36kA	160	830110	8874	830115	11426
	F2	36kA	200	830111	10540	830116	14102
	F2	36kA	250	830112	13364	830117	18078

**HSN Code: 8536**

	Frame	Breaking capacity	Rating	3P	Unit Price (₹)	4P	Unit Price (₹)
	F3	50kA	160	830134	10716	830154	13618
	F3	50kA	200	830135	12310	830155	16758
F3	50kA	250	830136	18730	830156	22684	

**HSN Code: 8536**

	Frame	Breaking capacity	Rating	3P	Unit Price (₹)	4P	Unit Price (₹)
	F4	36kA	315	830165	17570	830175	22562
	F4	36kA	400	830166	19700	830176	25124
	F4	36kA	500	830167	24376	830177	29340
F4	36kA	630	830168	25838	830178	31500	

**HSN Code: 8536**

	Frame	Breaking capacity	Rating	3P	Unit Price (₹)	4P	Unit Price (₹)
	F4	50kA	315	830185	21854	830195	24942
	F4	50kA	400	830186	24086	830196	27470
	F4	50kA	500	830187	25548	830197	30974
F4	50kA	630	830188	27228	830198	31798	

**HSN Code: 8536**

	Frame	Breaking capacity	Rating	3P	MRP	4P	MRP
F5	50kA	800	830200	34140	830201	43662	

—optium™— **OPTIUM 1.1 (FIXED TM RANGE MCCB)**

- Ics = 100% Icu as per IEC 60947-II
- Suitable for isolation
- Class II front face
- Fixed Overload & fixed short circuit setting

**HSN Code: 8536**



Frame	Breaking capacity	Rating	3P	Unit Price (₹)	4P	Unit Price (₹)
F1	16kA	32	840003	3802	840017	5138
F1	16kA	40	840004	3802	840018	5138
F1	16kA	63	840006	3802	840020	5138
F1	16kA	80	840007	3876	840021	5388
F1	16kA	100	840008	3876	840022	5388
F1	16kA	125	840009	5490	840023	7520
F1	25kA	32	840033	4912	840047	5986
F1	25kA	40	840034	4912	840048	5986
F1	25kA	63	840036	4912	840050	5986
F1	25kA	80	840037	5054	840051	6102
F1	25kA	100	840038	5054	840052	6102
F1	25kA	125	840039	6132	840053	8558
F2	16kA	160	840090	6528	840095	9210
F2	16kA	200	840091	8506	840096	10294
F2	16kA	250	840092	9694	840097	11800
F2	25kA	160	840100	7400	840105	10158
F2	25kA	200	840101	10080	840106	12962
F2	25kA	250	840102	13942	840107	16918

—optium™— **OPTIUM 2.0 (ADJUSTABLE THERMAL SETTING)**

- Conforms to IEC 60947-II
- Adjustable Overload Setting Ir = (0.8 to 1.0)In
- Ics = 100% Icu
- Class II front face
- Short Circuit setting fixed
- Suitable for isolation

**HSN Code: 8536**



Frame	Breaking capacity	Rating	3P	Unit Price (₹)	4P	Unit Price (₹)
F1	16kA	25	830222	4096	830236	5580
F1	16kA	32	830223	4096	830237	5580
F1	16kA	40	830224	4096	830238	5580
F1	16kA	50	830225	4096	830239	5580
F1	16kA	63	830226	4096	830240	5580
F1	16kA	80	830227	4618	830241	6236
F1	16kA	100	830228	4618	830242	6236
F1	16kA	125	830229	5776	830243	8198

**HSN Code: 8536**



Frame	Breaking capacity	Rating	3P	Unit Price (₹)	4P	Unit Price (₹)
F1	25kA	25	830252	4940	830266	6106
F1	25kA	32	830253	4940	830267	6106
F1	25kA	40	830254	4940	830268	6106
F1	25kA	50	830255	4940	830269	6106
F1	25kA	63	830256	4940	830270	6106
F1	25kA	80	830257	5184	830271	6406
F1	25kA	100	830258	5184	830272	6406
F1	25kA	125	830259	6289	830273	8282

**HSN Code: 8536**



Frame	Breaking capacity	Rating	3P	Unit Price (₹)	4P	Unit Price (₹)
F2	16kA	160	830280	5900	830285	8886
F2	16kA	200	830281	7840	830286	10388
F2	16kA	250	830282	9710	830287	13048
F2	25kA	160	830290	8542	830295	11294
F2	25kA	200	830291	10502	830296	14078
F2	25kA	250	830292	13210	830297	15632

—optium™— **OPTIUM 2.0 (ADJUSTABLE TM RANGE MCCB)**

- Ics =100% Icu as per IEC 60947-II
- Adjustable Overload Setting Ir =(0.8 to 1.0)xIn
- Class II front face
- Adjustable Short Circuit Setting Isd =(5 -10)xIn
- Suitable for isolation

**HSN Code: 8536**

	Frame	Breaking capacity	Rating	3P	Unit Price (₹)	4P	Unit Price (₹)
	F3	36kA	16	830305	6588	830325	8912
F3	36kA	25	830306	6588	830326	8912	
F3	36kA	32	830307	6588	830327	8912	
F3	36kA	40	830308	6588	830328	8912	
F3	36kA	50	830309	6588	830329	8912	
F3	36kA	63	830310	6588	830330	8912	
F3	36kA	80	830311	6716	830331	9174	
F3	36kA	100	830312	6716	830332	9174	
F3	36kA	125	830313	8296	830333	10278	

**HSN Code: 8536**

	Frame	Breaking capacity	Rating	3P	Unit Price (₹)	4P	Unit Price (₹)
	F3	50kA	16	830345	9352	830365	10498
F3	50kA	25	830346	9352	830366	10498	
F3	50kA	32	830347	9352	830367	10498	
F3	50kA	40	830348	9352	830368	10498	
F3	50kA	50	830349	9352	830369	10498	
F3	50kA	63	830350	9352	830370	10498	
F3	50kA	80	830351	9540	830371	10602	
F3	50kA	100	830352	9450	830372	10602	
F3	50kA	125	830353	10498	830373	12656	

**HSN Code: 8536**

	Frame	Breaking capacity	Rating	3P	Unit Price (₹)	4P	Unit Price (₹)
	F3	36kA	160	830314	10684	830334	12694
F3	36kA	200	830315	11980	830335	16562	
F3	36kA	250	830316	15286	830336	20702	

**HSN Code: 8536**

	Frame	Breaking capacity	Rating	3P	Unit Price (₹)	4P	Unit Price (₹)
	F3	50kA	160	830354	11454	830374	13566
F3	50kA	200	830355	13362	830375	17204	
F3	50kA	250	830356	18966	830376	21810	

**HSN Code: 8536**

	Frame	Breaking capacity	Rating	3P	Unit Price (₹)	4P	Unit Price (₹)
	F4	25kA	315	830385	19630	830387	22890
F4	25kA	400	830386	20098	830388	24972	
F4	36kA	315	830390	20042	830395	24212	
F4	36kA	400	830391	21320	830396	26068	
F4	36kA	500	830392	25348	830397	30866	
F4	36kA	630	830393	27538	830398	34574	
F4	50kA	315	830400	22424	830405	26982	
F4	50kA	400	830401	23932	830406	28336	
F4	50kA	500	830402	27952	830407	33220	
F4	50kA	630	830403	29638	830408	36166	



—optium™— **OPTIUM 2.0 (ADJUSTABLE TM RANGE MCCB)**

**HSN Code: 8536**

Frame	Breaking capacity	Rating	3P	Unit Price (₹)	4P	Unit Price (₹)
F5	36kA	800	830410	34874	830413	40090
F5	36kA	1000	830411	52734	830414	56552
F5	36kA	1250	830412	60992	830415	67956
F5	50kA	800	830416	36950	830419	52732
F5	50kA	1000	830417	64262	830420	69024
F5	50kA	1250	830418	70874	830421	79948

—optium™— **ACCESSORIES**

**HSN Code: 8538**

Product	Frame	Cat Ref.	Unit Price (₹)
Auxiliary contact	F1 F2 F3	830691	840
Auxiliary contact	F4-F5	830693	1102
Alarm Contact	F1 F2 F3	830692	840
Alarm Contact	F4-F5	830693	1102
Auxiliary contact / Alarm Contact	F1 F2 F3	830694	1260

**HSN Code: 8538**

Product	Frame	Cat Ref.	Unit Price (₹)
"Shunt trip 24 V AC/DC"	F1 F2 F3	830602	1020
"Shunt trip 110 V AC/DC"	F1 F2 F3	830603	1020
"Shunt trip 230 V AC/DC"	F1 F2 F3	830604	1020
"Shunt trip 415 V AC/DC"	F1 F2 F3	830605	1020
"Shunt trip 24 V AC/DC"	F4 F5	830642	1872
"Shunt trip 110 V AC/DC"	F4 F5	830643	1872
"Shunt trip 230 V AC/DC"	F4 F5	830644	1872
"Shunt trip 415 V AC/DC"	F4 F5	830645	1872

**HSN Code: 8538**

Product	Frame	Cat Ref.	Unit Price (₹)
"Undervoltage 24 V DC"	F1 F2 F3	830606	1562
"Undervoltage 110V AC"	F1 F2 F3	830607	1562
"Undervoltage 230V AC"	F1 F2 F3	830608	1562
"Undervoltage 415V AC"	F1 F2 F3	830609	1562
"Undervoltage 24 V DC"	F4 F5	830646	1664
"Undervoltage 110V AC"	F4 F5	830647	1664
"Undervoltage 230V AC"	F4 F5	830648	1664
"Undervoltage 415V AC"	F4 F5	830649	1664

**HSN Code: 8538**

Product	Frame	Cat Ref.	Unit Price (₹)
Rotary Handle Direct	F1	830611	1196
Rotary Handle vary-Depth	F1	830612	1196
Rotary Handle Direct	F2 F3	830626	1404
Rotary Handle vary-Depth	F2 F3	830627	1404
Rotary Handle Direct	F4	830651	1664
Rotary Handle vary-Depth	F4	830652	1664
Rotary Handle Direct	F5	830671	3258
Rotary Handle vary-Depth	F5	830672	3258

—optium™— **ACCESSORIES**

**HSN Code: 8538**

	Product	Frame	Cat Ref.	Unit Price (₹)
	Ronis lock Direct RH	F1 F2 F3	830613	1402
	Ronis lock Vary-Depth RH	F1 F2 F3	830614	1402
	Ronis lock Vary-Depth RH	F4	830653	1890

**HSN Code: 8538**

	Product	Frame	Cat Ref.	Unit Price (₹)
	Padlock Off position	F1 F2 F3	830615	1910
	Padlock Off position	F4	830654	1910
	Padlock Off position	F5	830674	1910

**HSN Code: 8538**

	Product	Frame	Cat Ref.	Unit Price (₹)
	Phase insulators 3P	F1 F2	830616	POR
	Phase insulators 3P	F3	830628	POR
	Phase insulators 3P	F4	830655	POR
	Phase insulators 3P	F5	830675	POR
	Phase insulators 4P	F1 F2	830617	POR
	Phase insulators 4P	F3	830629	POR
	Phase insulators 4P	F4	830656	POR
	Phase insulators 4P	F5	830676	POR

**HSN Code: 8538**

	Product	Frame	Cat Ref.	Unit Price (₹)
	Spreaders 3P	F1	830618	344
	Spreaders 4P	F1	830619	502
	Spreaders 3P	F2 F3	830632	918
	Spreaders 4P	F2 F3	830633	1832
	Spreaders 3P	F4	830659	2932
	Spreaders 4P	F4	830660	4276
	Spreaders 3P 800/1000A	F5	830681	7576
	Spreaders 4P 800/1000A	F5	830682	11110
	Spreaders 3P 1250A	F5	830685	7878
	Spreaders 4P 1250A	F5	830686	11616

**HRC FUSE LINKS & BASES**

**BOLTED TYPE (BS) BREAKING CAPACITY ≥ 80kA 500 V AC 50 Hz.**

**HSN Code: 8536**

	Rating	Type	Cat Ref.	Tag Type	Unit Price (₹)	Unit/Carton
	2, 4, 6, 8, 10, 16A	FGN	IEFGN***	Offset	64	20
	20, 25, 32A	FGN	IEFGN***	Offset	72	20
	2, 4, 6, 10, 16, 20, 25, 32A	FSA	IEFSA***	Offset	98	10
	35, 40, 50, 63A	FSS	IEFSS***	Offset	110	10
	50, 63, 80, 100, 125, 160A	FSDCP	IEDCP***	Offset	232	10
	100, 125, 160, 200, 250A	FSFP	IESFP***	Offset	334	3
	50, 63, 80, 100, 125A	FSDC	IESDC***	Central	232	10
	100, 125, 160, 200, 250A	FSF	IEFSF***	Central	340	3
	225, 250, 300, 315, 320A	FSK	IEFSK***	Central	492	3
	355, 400A	FMF	IEFMF***	Central	952	3
	355, 400, 450, 500, 560, 600, 630A	FTS	IEFTS***	Central	1098	1
	355, 400, 450, 500, 560A	FTM	IEFTM***	2 Central	1430	1
	600, 630A	FTM	IEFTM***	2 Central	1950	1

**DIN TYPE BREAKING CAPACITY ≥ 80kA 500 V AC 50 Hz.**

**HSN Code: 8536**

	Rating Amps	Type	Cat Ref.	Unit Price (₹)	Unit/Carton
	2, 4, 6, 10, 16, 20, 25, 32, 50, 63A	Size 000	IWS00***	290	6
	2, 4, 6, 10, 16, 20, 25, 32, 36, 40, 50, 63A	Size 00	IW000***	310	6
	80, 100A		IW000***	322	6
	125, 160A		IW000***	342	6
	32, 36, 50, 63, 80, 100, 125, 160, 200A	Size 01	IW001***	564	3
	250A		IW001***	642	3
	100, 125, 200, 250, 315A	Size 02	IW002***	830	3
	400A		IW002***	898	3
	315, 355, 400, 425A	Size 03	IW003***	1138	3
	500, 630A		IW003***	1326	3

\* Note HRC fuses with SC breaking capacity 120kA are available on request.

**CYLINDRICAL TYPE (IFRH) BREAKING CAPACITY > 80kA 415 V AC.**

**HSN Code: 8536**

	Rating	Cat Ref.	Unit Price (₹)
	2 to 25A	IFRHO***	122
	32 to 40A	IFRHO***	130
	50A	IFRH0050	238
	63A	IFRH0063	244
	Fuse Holder Fr type (2 to 63A)	IFR00***	228

**FUSE FITTINGS FOR BOLTED (BS) TYPE**

**HSN Code: 8536**

	Rating	Front Connection	Unit Price (₹)	Back Busbar Connection	Unit Price (₹)	Unit/Carton
	20A	BFFC 0020	138	BFBC 0020	150	10
	32A	BFFC 0032	242	BFBC 0032	254	10
	63A	BFFC 0063	350	BFBC 0063	368	5
	100A	BFFC 0100	902	BFBC 0100	928	3
	20A (Stud Type)			BFCS 020	202	1



**FUSE BASES FOR DIN TYPE HRC FUSE LINKS**

**HSN Code: 8536**

	Rating Amps	Suitable for	Cat Ref.	Unit Price (₹)	Unit/Carton
	6-160A	Size - 00	IWFB0***	396	6
	32-250A	Size - 1	IWFB1***	758	2
	100-400A	Size - 2	IWFB2***	1132	2
	315-630A	Size - 3	IWFB3***	1436	2

**SWITCH DISCONNECTOR FUSES**

**HSN Code: 8536**

Rated Current	Type	IN OPEN EXECUTION*		IN SHEET STEEL ENCLOSURE		Recommended HRC Fuse Indo Asian Make	
		Cat Ref.	Unit Price (₹)	Cat Ref.	Unit Price (₹)		
	32A BS	TPN	INO1A032	1674	INS1A032	3284	FSA
	63A BS	TPN	INO1A063	2314	INS1A063	4186	FSS
	100A BS	TPN	INO1A100	5088	INS1A100	7118	FSDCP
	125A BS	TPN	INO1A125	5442	INS1A125	8208	FSDCP
	160A BS	TPN	INO1A160	6588	INS1A160	9164	FSDCP
	200A BS	TPN	INO1A200	8196	INS1A200	11082	FSF
	250A BS	TPN	INO1A250	9254	INS1A250	12438	FSF
	315A BS	TPN	INO1A315	11860	INS1A315	15532	FSK
	400A BS	TPN	INO1A400	14718	INS1A400	18540	FMF
	32A BS	TPSN	INO1B032	2126	INS1B032	3668	FSA
	63A BS	TPSN	INO1B063	2700	INS1B063	4340	FSS
	100A BS	TPSN	INO1B100	6258	INS1B100	8120	FSDCP
	125A BS	TPSN	INO1B125	6852	INS1B125	8692	FSDCP
	160A BS	TPSN	INO1B160	8570	INS1B160	11236	FSDCP
	200A BS	TPSN	INO1B200	9762	INS1B200	12668	FSF
	250A BS	TPSN	INO1B250	10642	INS1B250	13826	FSF
	315A BS	TPSN	INO1B315	15060	INS1B315	19872	FSK
	400A BS	TPSN	INO1B400	17814	INS1B400	21372	FMF

\* Price Does Not Include HRC Fuse

**HSN Code: 8536**

Rated Current	Type	IN OPEN EXECUTION*		IN SHEET STEEL ENCLOSURE		Recommended HRC Fuse Indo Asian Make	
		Cat Ref.	Unit Price (₹)	Cat Ref.	Unit Price (₹)		
	32A DIN	TPN	IN10A032	1758	IN1SA032	3250	Size 000
	63A DIN	TPN	IN10A063	2438	IN1SA063	4132	Size 000
	100A DIN	TPN	IN10A100	5216	IN1SA100	7040	Size 00
	125A DIN	TPN	IN10A125	5580	IN1SA125	8184	Size 00
	160A DIN	TPN	IN10A160	6714	IN1SA160	8990	Size 00
	200A DIN	TPN	IN10A200	8460	IN1SA200	10234	Size 01
	250A DIN	TPN	IN10A250	9390	IN1SA250	12316	Size 01
	315A DIN	TPN	IN10A315	12284	IN1SA315	15334	Size 02
	400A DIN	TPN	IN10A400	15140	IN1SA400	18176	Size 02
	630A DIN	TPN	IN10A630	25020	IN1SA630	26946	Size 03
	800A DIN	TPN	IN10A800	30508	IN1SA800	38144	Size 03
	32A DIN	TPSN	IN10B032	2334	IN1SB032	3612	Size 000
	63A DIN	TPSN	IN10B063	2688	IN1SB063	3900	Size 000
	100A DIN	TPSN	IN10B100	6026	IN1SB100	7778	Size 00
	125A DIN	TPSN	IN10B125	6676	IN1SB125	8372	Size 00
	160A DIN	TPSN	IN10B160	7822	IN1SB160	11194	Size 00
	200A DIN	TPSN	IN10B200	9090	IN1SB200	11808	Size 01
	250A DIN	TPSN	IN10B250	10412	IN1SB250	13528	Size 01
	315A DIN	TPSN	IN10B315	13936	IN1SB315	18408	Size 02
	400A DIN	TPSN	IN10B400	16194	IN1SB400	21284	Size 02
	630A DIN	TPSN	IN10B630	25998	IN1SB630	31438	Size 03
	800A DIN	TPSN	IN10B800	31176	IN1SB800	41958	Size 03

\* Price Does Not Include HRC Fuse

**SWITCH DISCONNECTOR 4 POLE**

HSN Code: 8536

Rated Current	IN OPEN EXECUTION*		IN SHEET STEEL ENCLOSURE	
	Cat Ref.	Unit Price (₹)	Cat Ref.	Unit Price (₹)
32A	IN1SD032	2280	IN1ED032	3136
63A	IN1SD063	2662	IN1ED063	3704
100A	IN1SD100	3872	IN1ED100	6728
125A	IN1SD125	5654	IN1ED125	7636
160A	IN1SD160	6368	IN1ED160	9118
200A	IN1SD200	8590	IN2ED200	11070
250A	IN1SD250	9362	IN2ED250	14604
315A	IN1SD315	11708	IN3ED315	15962
400A	IN1SD400	14198	IN3ED400	18714
630A	IN1SD630	21626	IN4ED630	27302
800A	IN1SD800	25758	IN4ED800	32220

\*Prices of 3 Pole SD is available on Request.

**Ambidex CHANGEOVER SWITCHES  
ON-LOAD CHANGEOVER SWITCHES 4 POLE**

HSN Code: 8536

Rated Current	IN OPEN EXECUTION		IN SHEET STEEL ENCLOSURE	
	Cat Ref.	Unit Price (₹)	Cat Ref.	Unit Price (₹)
63A	ITAE0063	4466	ITAS0063	5864
100A	ITAE0100	5928	ITAS0100	7782
125A	ICAE0125	8882	ICAS0125	11658
160A	ICAE0160	9768	ICAS0160	12822
200A	ICAE0200	11744	ICAS0200	15414
250A	ICAE0250	14358	ICAS0250	18842
320A	ICAE0320	18824	ICAS0320	24708
400A	ICAE0400	27316	ICAS0400	35852
630A	ICAE0630	32490	ICAS0630	42644
800A	ITAE0800	47124	ITAS0800	61854
1000A	ITAE1000	78208	ITAS1000	102648
1250A	ITAE1250	106922	ITAS1250	140336
1600A	ITAE1600	147606	ITAS1600	193732
2000A	ITAE2000	188514	ITAS2000	247426
2500A	ITAE2500	252284	ITAS2500	331124
3150A	ITAE3150	291940	ITAS3150	420466

HSN Code: 8536

ACCESSORIES FOR AMBIDEX CHANGEOVER SWITCHES	Cat Ref.	Unit Price (₹)
Auxiliary Switch 200A-630A (1NO + 1NC)	ICA00AUX	194
Spreader Links for Frame00 - 1 set (4 links)	ICA00SPL	350

**ON-LOAD SWITCH FUSE CHANGEOVER**

HSN Code: 8536

Rated Current	IN OPEN EXECUTION		IN SHEET STEEL ENCLOSURE		Recommended HRC Fuse Indo Asian Make
	Cat Ref.	Unit Price (₹)	Cat Ref.	Unit Price (₹)	
125A	ITBE0125	12954	ITBS0125	17488	FSDCP
200A	ITBE0200	23668	ITBS0200	31040	FSF
250A	ITBE0250	23890	ITBS0250	31328	FSK
320A	ITBE0320	24666	ITBS0320	32348	FSK
400A	ITBE0400	35380	ITBS0400	46398	FTS
630A	ITBE0630	41290	ITBS0630	54154	FTS

Price does not include HRC Fuses.

**ON-LOAD BY-PASS SWITCHES**

HSN Code: 8536

Rated Current	IN OPEN EXECUTION		IN SHEET STEEL ENCLOSURE	
	Cat Ref.	Unit Price (₹)	Cat Ref.	Unit Price (₹)
125A	ITCE0125	16660	ITCS0125	22494
200A	ITCE0200	21214	ITCS0200	28638
250A	ITCE0250	30816	ITCS0250	41604
320A	ITCE0320	31998	ITCS0320	43200
400A	ITCE0400	47998	ITCS0400	64800
630A	ITCE0630	54532	ITCS0630	73620

**REWIRABLE SWITCH FUSE UNIT**

**HSN Code: 8537**

 <ul style="list-style-type: none"> <li>• Single Pole &amp; Neutral/Double Pole 240/415 VAC 50 Hz</li> <li>• Conforms to IS/IEC 13947-3</li> </ul>	Rating	Type	Cat Ref.	Rated Voltage	Unit Price* (₹)
	16A	SPN	RCSPN016	240 V	664
	32A	SPN	RCSPN032	240 V	1604
	16A	DP	RCDP0016	240 V	702
	32A	DP	RCDP0032	240 V	1648
	32A	DP	#DDP0032	415 V	2264
	63A	DP	#DDP0063	415 V	4246

# For Rewirable type carrier, prefix R, for HRC type carrier, prefix H.  
\* These prices are without wire & HRC.

**COMBINATION FUSE SWITCH**

**HSN Code: 8536**

 <ul style="list-style-type: none"> <li>• Double Break in Sheet steel enclosure</li> <li>• Conforms to IS/IEC 13947-3</li> <li>• Rated Voltage - 415V AC 50 Hz</li> <li>• Type - TPN</li> </ul>	Rating	HRC Fuse Type	Cat Ref.	Unit Price* (₹)
	63A	FSS	DDTPN063	8044
	100A	FSDCP	DDTPN100	10802
	200A	FSF	DDTPN200	16080
	300A	FSK	DDTPN300	20286
	400A	FTS	DDTPN400	29426

\* These prices are without HRC.

**TRIPLE POLE NEUTRAL HRC TYPE  
REWIRABLE SWITCH FUSE UNIT**

**HSN Code: 8537 H  
HSN Code: 8536 R**

 <ul style="list-style-type: none"> <li>• Rated Voltage - 415V-AC 50Hz</li> <li>• Type - TPN</li> </ul>	Rating	HRC Fuse Type	Cat Ref.	Unit Price* (₹)
	16A	FSA	#DTPN016	1940
	32A	FSA	#DTPN032	2612
	63A	FSS	#DTPN063	5560
	100A	FSDCP	#DTPN100	10140

# For Rewirable type carrier, prefix R, for HRC type carrier, prefix H.  
\* These prices are without wire & HRC.

**OFF LOAD CHANGEOVER SWITCH**

**HSN Code: 8536**

 <ul style="list-style-type: none"> <li>• With enclosure</li> <li>• Rated Voltage - 415V-AC 50Hz</li> <li>• Type - FP</li> </ul>	Rating	Cat Ref.	Unit Price (₹)
	32A (DP)	OFDP0032	1582
	16A	OFFP0016	2532
	32A	OFFP0032	2640
	63A	OFFP0063	5368
	100A	OFFP0100	10494
	125A	OFFP0125	14752
	200A	OFFP0200	15926
	250A	OFFP0250	20288
	315A	OFFP0315	20944
	400A	OFFP0400	24434

Prices for spares of Rewirable Switch Fuse Unit like Action Bar, Base Plate, End Shield, Bakelite Contact Shrouds are available on request.

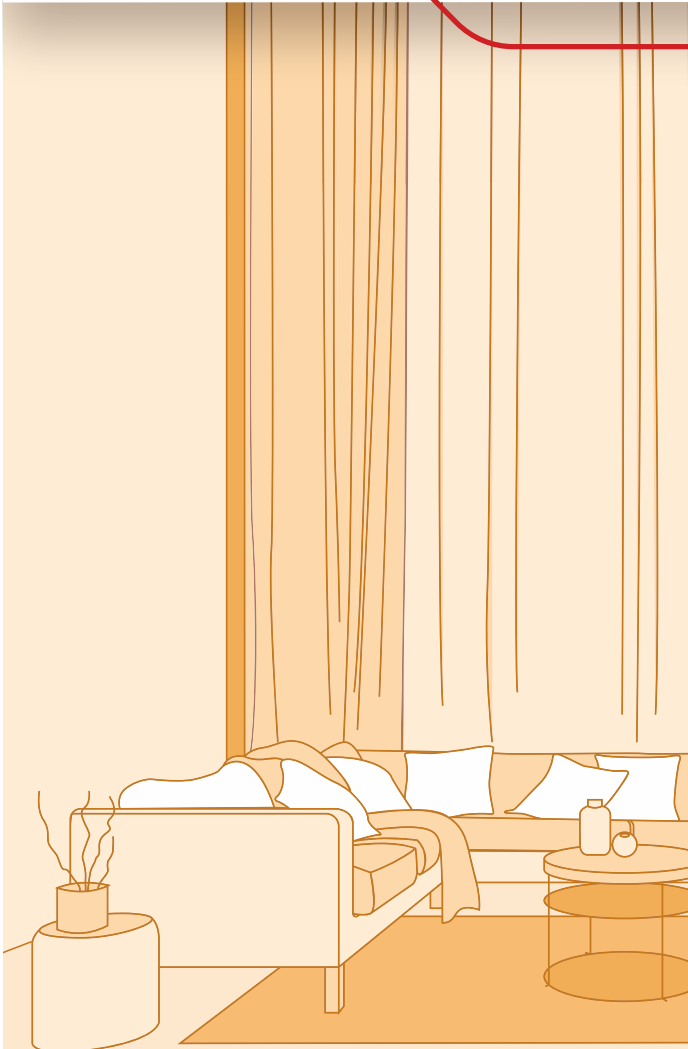

## GIVE YOUR WALLS A GLINT. PRESENTING NEW DOUBLE PLATE



Suitable for flush and wooden boxes



Comes with both wooden and metal screws



Range from 1M to 18M

**Glint**<sup>™</sup>  
Welcome Change

**Glint™ SWITCH / SWITCH WITH INDICATOR**

• Polycarbonate Material • LED Indicator • ISI Marked

HSN Code: 8536

	Description	Module	Pack	Cat. Nos.	Unit Price (₹)
	6A 1-way Switch	1	1/10/200	800000	26
	6A 2-way Switch	1	1/10/200	800001	54
	16A 1-way Switch	1	1/10/100	800002	74
	16A 2-way Switch	1	1/10/100	800003	86
	16A 1-way Switch with Indicator	1	1/10/100	800004	84
	20A DP Switch	2	1/10/50	800005	106
	32A DP Switch	2	1/10/50	800006	158
	6A Bell Push with Indicator-1M	1	1/10/100	800007	64
	6A Bell Push with Indicator-2M	2	1/10/100	800008	94

**Glint™ SOCKET / TELEPHONE SOCKET / COMPUTER SOCKET / TV SOCKET**

• Pencil Free Operation • Child Safety Shutter • Accommodate Wide Range of 2 Pin Round and Flat Pin Plugs

HSN Code: 8536

	Description	Module	Pack	Cat. Nos.	Unit Price (₹)
	6A 3 Pin Universal Socket	2	1/10/100	800020	54
	10A Euro US Socket	1	1/20/100	800021	52
	6/16A 3 Pin Socket	2	1/10/50	800022	102
	Multistandard Socket 6/10/13A-250V, 15A-127V	2	1/10/100	800023	98
	Telephone Socket - RJ11	1	1/20/100	800030	60
	Computer Socket- RJ45	1	1/20/100	800031	138
	TV Socket	1	1/20/100	800032	54

**Glint™ BUZZER / POWER UNIT / INDICATOR**

• Power Unit - Prewired, Suitable for 2 Ton Ac / 3.5 kw Geyser

HSN Code: 8536

	Description	Module	Pack	Cat. Nos.	Unit Price (₹)
	Buzzer - 230V	1	1/20/100	800040	146
	16A Power Unit for AC & Geyser	4	1/1/5	800025	258
Flat Indicator Red	1	1/10/100	800033	70	

**Glint™ FAN STEP REGULATOR**

• Fan Marking for Easy Identification

HSN Code: 8414

	Description	Module	Pack	Cat. Nos.	Unit Price (₹)
	Fan Step Regulator - 100W	1	1/10/100	800041	260
Fan Step Regulator - 100W - 2M	2	1/10/100	800043	296	

**Glint™ LIGHT DIMMER**

• Marking for Easy Identification

HSN Code: 8538

	Description	Module	Pack	Cat. Nos.	Unit Price (₹)
	Light Dimmer - 400W	1	1/10/100	800042	254

**Glint™ BLANK PLATE / SCREW CAPS**

• Spare Screw Caps Available

HSN Code: 8538

	Description	Module	Pack	Cat. Nos.	Unit Price (₹)
	1 Module Blank Plate	1	1/20/200	800051	22
	2 Module Blank Plate	2	1/10/100	800052	22
Screw Caps	-	1/10/100	800059	18*	

\* One Unit Contains Ten Pieces of Screw Caps



**Glint™ MODULAR PLATES - WHITE COLOUR**

- Unique Design - Sleek & Curvy • Flame Retardant Material • Compatible with all Standard Size Metal Flush & Plastic Surface Boxes

HSN Code: 8538

	Description	Module	Pack	Cat. Nos.	Unit Price (₹)
	1 Module Plate	1	1/10/100	800061	36
	2 Module Plate	2	1/10/100	800062	36
	3 Module Plate	3	1/10/100	800063	52
	4 Module Plate	4	1/10/100	800064	64
	6 Module Plate	6	1/5/50	800066	78
	8 Module Plate (Vertical)	8	1/5/25	800067	110
	8 Module Plate (Horizontal)	8	1/5/50	800068	102
	12 Module Plate	12	1/5/25	800065	142
	16 Module Plate	16	1/5/25	800069	148
18 Module Plate	18	1/5/25	800070	178	

**Glint™ MODULAR DOUBLE PLATES - WHITE COLOUR**

- Aesthetic Design • Suitable for Metal Flush & Wooden Boxes
- Comes in both Metal & Wooden Screws

HSN Code: 8538

	Description	Module	Pack	Cat. Nos.	Unit Price (₹)
	Double Plate + Frame 1M	1	1/10/100	800071	66
	Double Plate + Frame 2M	2	1/10/100	800072	66
	Double Plate + Frame 3M	3	1/10/100	800073	86
	Double Plate + Frame 4M	4	1/10/100	800074	106
	Double Plate + Frame 6M	6	1/10/50	800076	132
	Double Plate + Frame 8M (Vertical)	8	1/5/25	800078	188
	Double Plate + Frame 8M (Horizontal)	8	1/10/50	800079	188
	Double Plate + Frame 10M	10	1/5/25	800080	218
	Double Plate + Frame 12M (Vertical)	12	1/5/25	800082	238
	Double Plate + Frame 12M (Horizontal)	12	1/5/25	800084	238
	Double Plate + Frame 16M	16	1/5/25	800086	272
	Double Plate + Frame 18M	18	1/5/25	800088	296

**Glint™ METAL FLUSH BOX**

- Made of G.I. Sheet • Earth Terminal for Safety

HSN Code: 8538

	Description	Module	Pack	Cat. Nos.	Unit Price (₹)
	Metal Flush Box - 1 / 2 Module	1 / 2	1/0/40	800172	44
	Metal Flush Box - 3 Module	3	1/0/40	800173	64
	Metal Flush Box - 4 Module	4	1/0/40	800174	74
	Metal Flush Box - 6 Module	6	1/0/20	800176	114
	Metal Flush Box - 8 Module(V)	8	1/0/20	800177	150
	Metal Flush Box - 8 Module(H)	8	1/0/20	800178	150
	Metal Flush Box - 12 Module	12	1/0/10	800175	198
	Metal Flush Box - 16 Module	16	1/0/10	800179	230
	Metal Flush Box - 18 Module	18	1/0/10	800180	246

**Glint™ SURFACE BOX**

- Flame Retardant Material • Edge to Edge Fitting with Glint Plate

HSN Code: 8538

	Description	Module	Pack	Cat. Nos.	Unit Price (₹)
	Plastic Surface Box 1/2 Module	1 / 2	1/0/50	800182	52
	Plastic Surface Box - 3 Module	3	1/0/35	800183	62
	Plastic Surface Box - 4 Module	4	1/0/25	800184	72
	Plastic Surface Box - 6 Module	6	1/0/10	800186	108
	Plastic Surface Box - 8 Module (V)	8	1/0/15	800187	154
	Plastic Surface Box - 8 Module (H)	8	1/0/10	800188	156
	Plastic Surface Box - 12 Module	12	1/0/10	800185	184
	Plastic Surface Box - 16 Module	16	1/0/10	800189	230
	Metal Surface Box - 18 Module	18	1/0/10	800190	250

**Cover Plates - Glint™**

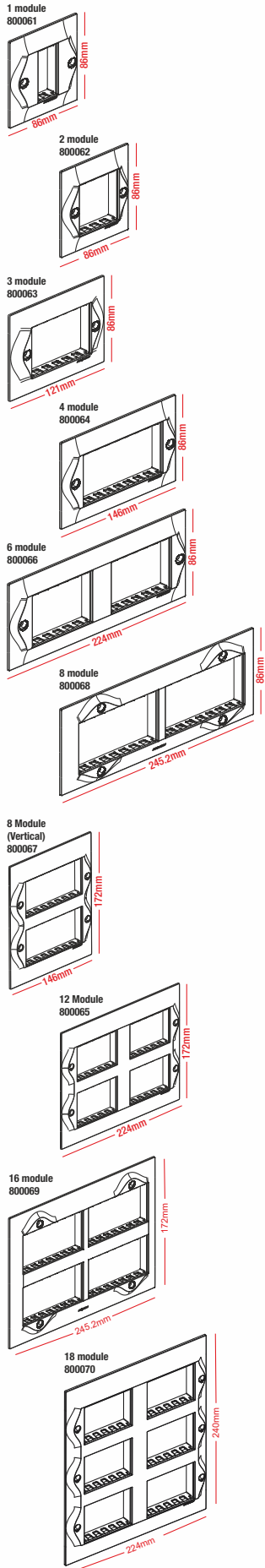

**Flush Boxes-Metal**

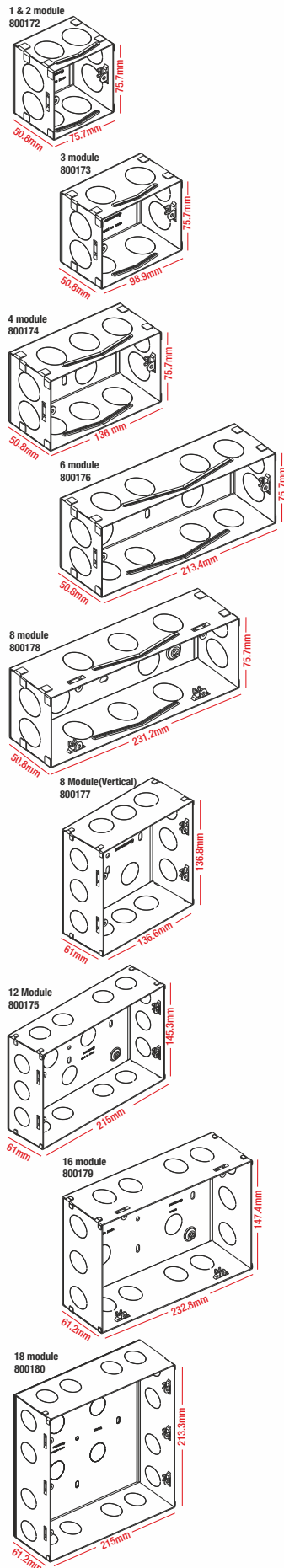

**Surface Boxes**

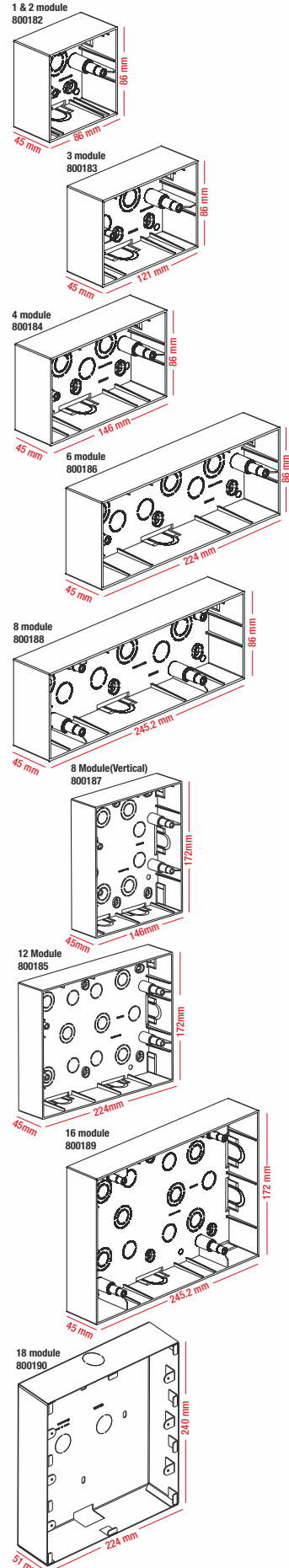

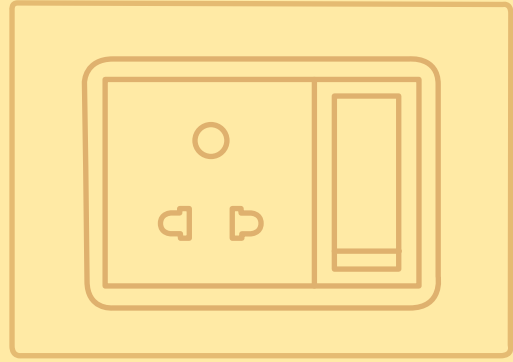
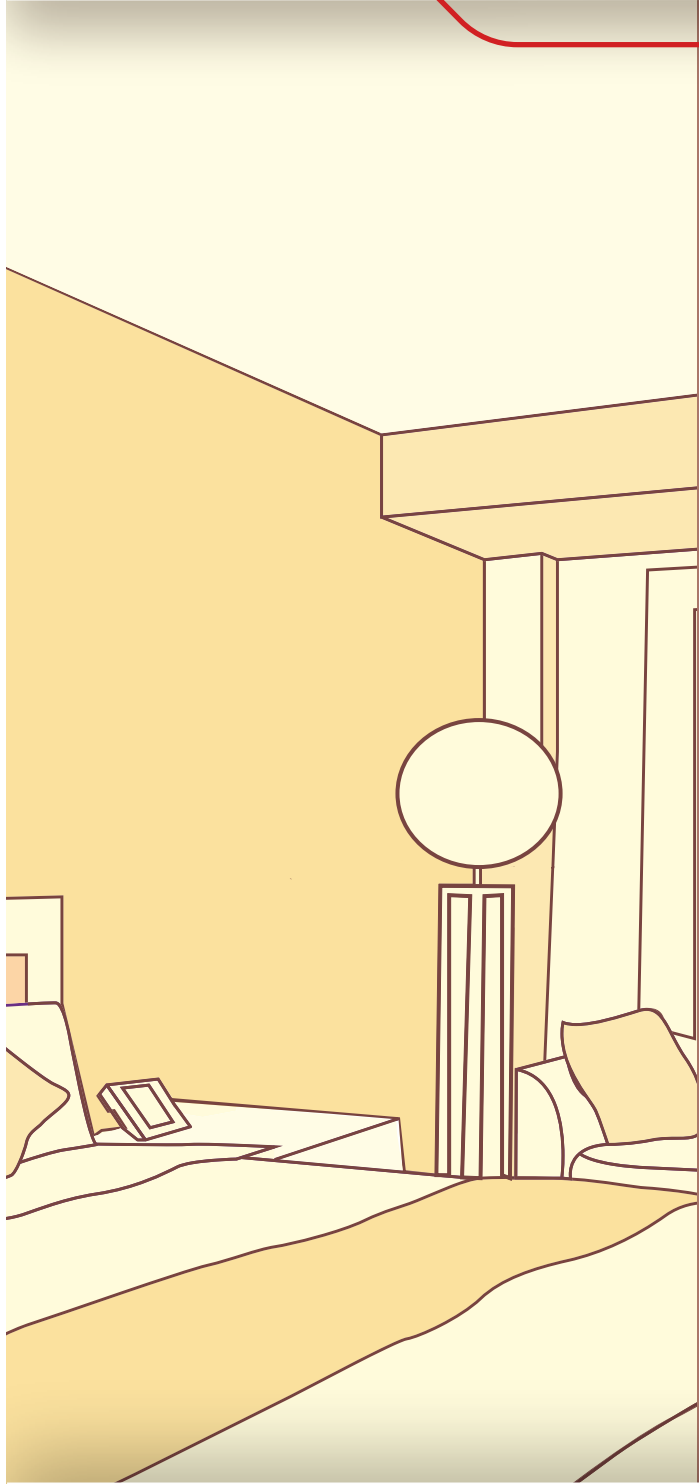

## UNIQUE AESTHETIC DESIGN - PLUGS WITH EASY GRIP



White Matte Finish



Tested as per IS 1293

Description	HSN Code	Pack	Cat. Nos.	Unit Price (₹)
6A 3 Pin Plug	8536	1/10/50	698470	45
16A 3 Pin Plug	8536	1/10/50	698471	65



\*Tested in a controlled environment

## NEW COLOUR PLATES THAT REFLECT YOUR STYLE



Trending colours



Contemporary finishes



More resistant to scratches and fading \*

**ELVIRA**  
A SENSIBLE SWITCH

**ELVIRA SWITCH / SWITCH WITH INDICATOR**

A SENSIBLE SWITCH

• Polycarbonate Material • LED Based Indicator • Shrouded Terminal • ISI Marked

HSN Code: 8536

Description	Module	Pack	Cat. Nos.	Unit Price (₹)	
6A 1 way Switch	1	1/20/200	800100	32	
6A 2 way Switch	1	1/20/100	800101	64	
6A 1 way Switch with Indicator	1	1/20/200	800102	68	
16A 1 way Switch	1	1/20/200	800103	88	
16A 2 way Switch	1	1/10/100	800104	108	
16A 1way Switch with indicator	1	1/20/200	800105	100	
25A 1 way Switch with indicator	1	1/10/100	800106	150	
20A DP Switch	2	1/10/50	800107	146	
32A DP Switch	2	1/10/50	800108	200	
6A Bell Push with indicator - 1M	1	1/20/200	800110	70	
6A Bell Push with indicator - 2M	2	1/10/100	800111	116	

**ELVIRA SOCKET**

A SENSIBLE SWITCH

• Child Safety Shutter • Shrouded Terminals • Compatible with all standard Mobile chargers

HSN Code: 8536

Description	Module	Pack	Cat. Nos.	Unit Price (₹)	
6A 3 Pin Universal Socket	2	1/10/100	800120	78	
10A Euro US Socket	1	1/20/100	800121	62	
6/16A 3 Pin Socket	2	1/10/50	800122	136	
25A 3 Pin Socket	2	1/10/50	800124	152	
Multistandard Socket 6/10/13A-250v	2	1/10/100	800123	126	

**ELVIRA USB CHARGER**

A SENSIBLE SWITCH

Modular charging socket to charge your Mobile , Tested as per IS standard

HSN Code: 8536

Description	Module	Pack	Cat. Nos.	Unit Price (₹)	
USB Charger	1	10/100	800112	610	
USB Charger	2	5/50	800113	1048	

**ELVIRA RJ11 / RJ45 / TV SOCKET**

A SENSIBLE SWITCH

Tool less, Twisted operation Computer Socket/RJ45

HSN Code: 8536

Description	Module	Pack	Cat. Nos.	Unit Price (₹)	
Telephone Socket - RJ11	1	1/20/100	800130	72	
Computer Socket - RJ45 Cat 6	1	1/20/100	800131	200	
TV Socket	1	1/20/100	800132	68	

**ELVIRA FAN REGULATOR**

A SENSIBLE SWITCH

• Laser marking

HSN Code: 8414

Description	Module	Pack	Cat. Nos.	Unit Price (₹)	
Fan Step Regulator 100W - 1M	1	1/10/100	800141	290	
Fan Step Regulator 100W - 2M	2	1/10/100	800142	352	

**ELVIRA POWER UNIT / CONTROL PRODUCTS / MINI MCB**

A SENSIBLE SWITCH

- LED Indicator • Pre-Wired Power Unit

HSN Code: 8536

Description	Module	Pack	Cat. Nos.	Unit Price (₹)
Buzzer 230V	1	1/20/100	800140	204
Power Unit with 16A AC & GYSR	3	1/1/5	800125	290
Power Unit with 20A MCB & PLUG	3	1/1/5	800193	708
Power Unit with 25A MCB & PLUG	3	1/1/5	800194	762
Bell Call Indicator	1	1/20/100	800144	450
Flat Indicator Red	1	1/20/100	800154	90
Skirting light - 2M	2	1/5/25	800155	324
25A Motor Starter	2	1/10/50	800196	344
16A Mini MCB SP C curve	1	1/10/100	800160	304
20A Mini MCB SP C curve	1	1/10/100	800191	304
25A Mini MCB SP C curve	1	1/10/100	800156	304
32A Mini MCB SP C curve	1	1/10/100	800157	304

**ELVIRA LIGHT DIMMER**

A SENSIBLE SWITCH

- Laser marking

HSN Code: 8538

Description	Module	Pack	Cat. Nos.	Unit Price (₹)
Light Dimmer 400W	1	1/10/100	800143	298

**ELVIRA BLANK PLATES / CABLE OUTLET**

A SENSIBLE SWITCH

- Polycarbonate Material

HSN Code: 8538

Description	Module	Pack	Cat. Nos.	Unit Price (₹)
1 module Blank	1	1/20/200	800151	24
2 module Blank	2	1/10/100	800152	38
Cable outlet	1	1/20/100	800153	62

**ELVIRA MODULAR PLATE WITH SUPPORT FRAME - WHITE**

A SENSIBLE SWITCH

- Strong Dimensional Stability

HSN Code: 8538

Description	Module	Pack	Cat. Nos.	Unit Price (₹)
1 Module Plate	1	1/10/100	800161	54
2 Module Plate	2	1/10/100	800162	54
3 Module Plate	3	1/10/100	800163	74
4 Module Plate	4	1/10/100	800164	80
6 Module Plate	6	1/5/50	800166	110
8 Module Plate (Horizontal)	8	1/5/50	800168	144
8 Module Plate (Vertical)	8	1/5/25	800167	148
12 Module Plate	12	1/5/25	800165	212
16 Module Plate	16	1/5/25	800169	242
18 Module Plate	18	1/5/25	800170	288

**ELVIRA MODULAR PLATE WITH SUPPORT FRAME - SILVER LIGHT PURPLE**

A SENSIBLE SWITCH

• Strong Dimensional Stability



HSN Code: 8538

 	Description	Module	Pack	Cat. Nos.	Unit Price (₹)
	Silver Light purple Plate 1M	1	1/10/100	800201	96
	Silver Light purple Plate 2M	2	1/10/100	800202	96
	Silver Light purple Plate 3M	3	1/10/100	800203	122
	Silver Light purple Plate 4M	4	1/10/100	800204	142
	Silver Light purple Plate 6M	6	1/5/50	800205	202
	Silver Light purple Plate 8M (Horizontal)	8	1/5/50	800206	222
	Silver Light purple Plate 8M (Vertical)	8	1/5/25	800207	266
	Silver Light purple Plate 12M	12	1/5/25	800208	370
	Silver Light purple Plate 16M	16	1/5/25	800209	516
Silver Light purple Plate 18M	18	1/5/25	800210	540	

**ELVIRA MODULAR PLATE WITH SUPPORT FRAME - INOX SILVER**

A SENSIBLE SWITCH



HSN Code: 8538

 	Description	Module	Pack	Cat. Nos.	Unit Price (₹)
	Inox Silver Plate 1M	1	1/10/100	800211	96
	Inox Silver Plate 2M	2	1/10/100	800212	96
	Inox Silver Plate 3M	3	1/10/100	800213	122
	Inox Silver Plate 4M	4	1/10/100	800214	142
	Inox Silver Plate 6M	6	1/5/50	800215	202
	Inox Silver Plate 8M (Horizontal)	8	1/5/50	800216	222
	Inox Silver Plate 8M (Vertical)	8	1/5/25	800217	266
	Inox Silver Plate 12M	12	1/5/25	800218	370
	Inox Silver Plate 16M	16	1/5/25	800219	516
Inox Silver Plate 18M	18	1/5/25	800220	540	

**ELVIRA MODULAR PLATE WITH SUPPORT FRAME - POLARISED GREY**

A SENSIBLE SWITCH



HSN Code: 8538

 	Description	Module	Pack	Cat. Nos.	Unit Price (₹)
	Polarised Grey Plate 1M	1	1/10/100	800221	106
	Polarised Grey Plate 2M	2	1/10/100	800222	106
	Polarised Grey Plate 3M	3	1/10/100	800223	130
	Polarised Grey Plate 4M	4	1/10/100	800224	152
	Polarised Grey Plate 6M	6	1/5/50	800225	222
	Polarised Grey Plate 8M (Horizontal)	8	1/5/50	800226	236
	Polarised Grey Plate 8M (Vertical)	8	1/5/25	800227	284
	Polarised Grey Plate 12M	12	1/5/25	800228	400
	Polarised Grey Plate 16M	16	1/5/25	800229	548
Polarised Grey Plate 18M	18	1/5/25	800230	574	

**ELVIRA MODULAR PLATE WITH SUPPORT FRAME - ASH PURPLE**

A SENSIBLE SWITCH

HSN Code: 8538

 	Description	Module	Pack	Cat. Nos.	Unit Price (₹)
	Ash Purple Plate 1M	1	1/10/100	800231	106
	Ash Purple Plate 2M	2	1/10/100	800232	106
	Ash Purple Plate 3M	3	1/10/100	800233	130
	Ash Purple Plate 4M	4	1/10/100	800234	152
	Ash Purple Plate 6M	6	1/5/50	800235	222
	Ash Purple Plate 8M (Horizontal)	8	1/5/50	800236	236
	Ash Purple Plate 8M (Vertical)	8	1/5/25	800237	284
	Ash Purple Plate 12M	12	1/5/25	800238	400
	Ash Purple Plate 16M	16	1/5/25	800239	548
Ash Purple Plate 18M	18	1/5/25	800240	574	

**ELVIRA METAL FLUSH BOX**

A SENSIBLE SWITCH

• Made of G.I. Sheet • Earth Terminal for Safety

HSN Code: 8538

	Description	Module	Pack	Cat. Nos.	Unit Price (₹)
	Metal Flush Box - 1 / 2 Module	1 / 2	1/0/40	800172	44
	Metal Flush Box - 3 Module	3	1/0/40	800173	64
	Metal Flush Box - 4 Module	4	1/0/40	800174	74
	Metal Flush Box - 6 Module	6	1/0/20	800176	114
	Metal Flush Box - 8 Module(V)	8	1/0/20	800177	150
	Metal Flush Box - 8 Module(H)	8	1/0/20	800178	150
	Metal Flush Box - 12 Module	12	1/0/10	800175	198
	Metal Flush Box - 16 Module	16	1/0/10	800179	230
	Metal Flush Box - 18 Module	18	1/0/10	800180	246

**ELVIRA SURFACE BOX**

A SENSIBLE SWITCH

• Flame Retardant Material • Edge to Edge Fitting with Plate

HSN Code: 8538

	Description	Module	Pack	Cat. Nos.	Unit Price (₹)
	Plastic Surface Box 1/2 Module	1 / 2	1/0/50	800182	52
	Plastic Surface Box - 3 Module	3	1/0/35	800183	62
	Plastic Surface Box - 4 Module	4	1/0/25	800184	72
	Plastic Surface Box - 6 Module	6	1/0/10	800186	108
	Plastic Surface Box - 8 Module (V)	8	1/0/15	800187	154
	Plastic Surface Box - 8 Module (H)	8	1/0/10	800188	156
	Plastic Surface Box - 12 Module	12	1/0/10	800185	184
	Plastic Surface Box - 16 Module	16	1/0/10	800189	230
	Metal Surface Box - 18 Module	18	1/0/10	800190	250



**Cover Plates - ELVIRA**  
A SENSIBLE SWITCH

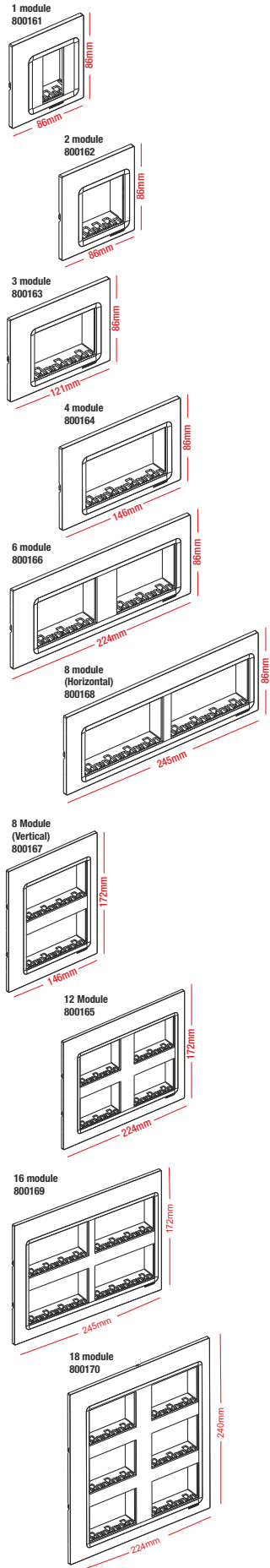

**Flush Boxes-Metal**

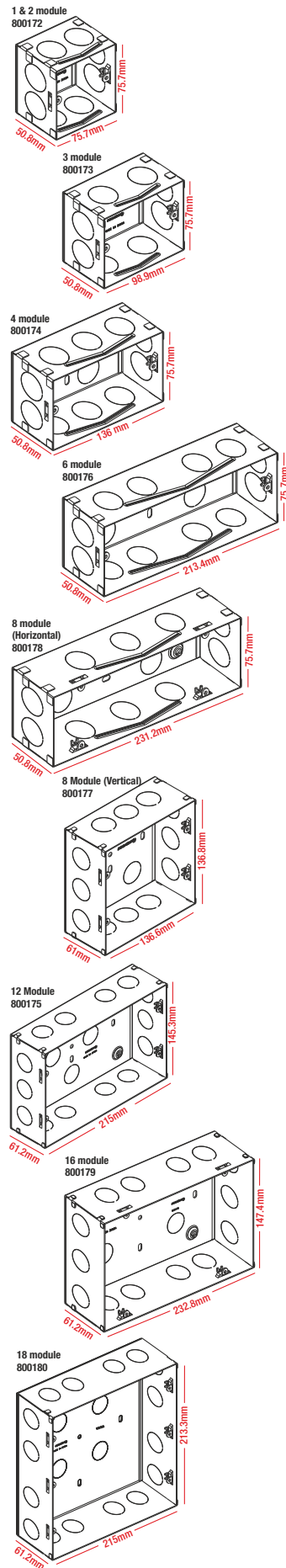

**Surface Boxes**

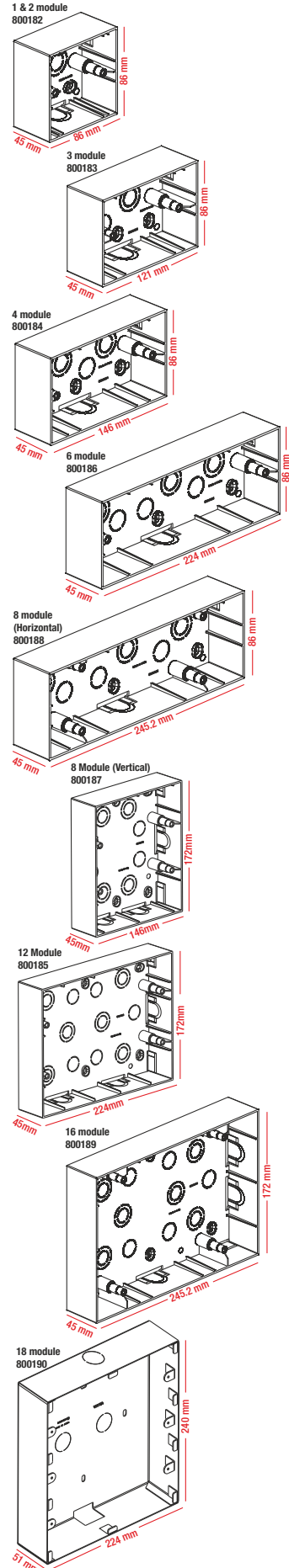

---

---

---

---

---

---

---

---

---

---

---

---

---

---

---

---

---

---

---

---

---

---

---

---

---

---

---

---





## GENERAL TERMS

- This price list supersedes all previous price lists.
- All prices are in Indian Rupees only.
- All prices are Maximum Retail Prices (MRP) inclusive of GST as applicable.
- Our discount structure is exclusive of GST
- Orders will be accepted in multiples of standard packing.
- Prices are subject to change without notice. All despatches will be as per prices prevailing on the date of despatch. Prices are ex-godown, exclusive of packing/forwarding/freight and insurance.
- Product design is subject to change without notice for continuous up gradation.
- Disputes if any are subject to Delhi Jurisdiction only.
- Company reserves the right to issue amendments which may arise due to any printing errors in the price list.

## WARRANTY

IA products carry a warranty against manufacturing defects, subject to use of the product for the right application, with correct wiring/connection and normal operating conditions. Please refer to detailed IndoAsian warranty policy effective 1<sup>st</sup> Jan 2016.

MCBs	36 Months
RCCBs	36 Months
DBs/ACCL	12 Months
Rewirable/HRC Fuses	6 Months
MCCBs/BFF/Fuse Bases/Changeover Switchgears/SDF	12 Months
Time Switches	12 Months
For Wiring Devices - Switches & Socket	120 Months
For Wiring Devices - Electronic Products (e.g. Fan Regulator, Dimmer, Buzzer, RJ45, RJ11 & TV Sockets, Bell Indicator, Motor starter, Skirting light)	24 Months

## CHANNEL PARTNER



**CORPORATE OFFICE:** V. J. Business Towers, A-6, 1st Floor, Sector-125, Noida- 201303, U.P., India. Ph.: +91-0120-686 4444, 3305100 E-mail: sales@indoasian.com, international@indoasian.com Website: www.indoasian.com

**CUSTOMER CARE HEAD:** Novateur Electrical & Digital Systems Pvt. Ltd., V.J. Business Towers, A-6, 1st Floor, Sector-125, Noida- 201303, U.P., INDIA. Ph: + 91-0120-3305111 E-mail: feedback@indoasian.com

### NORTH

#### Regional Sales office

#### DELHI NCR

V. J. Business Towers  
A-6, Ground Floor,  
Sector-125, Noida-201303  
Ph.: 0120-6858900  
E-Mail: in-delhi-office@indoasian.com

#### Branch office

#### CHANDIGARH

S.C.O.-11, 2nd Floor,  
Sector-26, Madhya Marg,  
Chandigarh-160002  
Ph.: 0172-3934651  
E-Mail: in-chandigarh-office@indoasian.com

#### Branch office

#### JAIPUR

433, 4th Floor, Ganpati Plaza,  
M. I. Road,  
Jaipur-302001  
Ph.: 0141-4113528  
E-Mail: in-jaipur-office@indoasian.com

#### Branch office

#### LUCKNOW

301, 3rd Floor, Chintel House,  
Station Road,  
Lucknow-226001  
Ph.: 0522-4013210  
E-Mail: in-lucknow-office@indoasian.com

### SOUTH

#### Regional Sales office

#### BANGALORE

787, 1st Floor "Skyline Vista"  
15th Cross, 100 Feet Ring Road  
J P Nagar 1st Phase  
Bangalore-560 078  
Tel: 080-46219999  
E-Mail: in-bangalore-office@indoasian.com

#### Branch office

#### COCHIN

Door No.65/1317, Syda Building,  
2nd Floor, Kaloor-Kadavanthra Road,  
Kaloor, Ernakulam District,  
Kochi-682017 (Kerala)  
Ph.: 0484-4055581-88  
E-Mail: in-cochin-office@indoasian.com

#### Branch office

#### COIMBATORE

Door No. 83,  
Dr. Nanjappa Road,  
Coimbatore-641018  
Ph.: 0422-2302715  
E-Mail: in-coimbatore-office@indoasian.com

#### Branch office

#### CHENNAI

No.5, 1st Floor, Mahalingapuram Main Road,  
Nungambakkam,  
Chennai-600034  
Ph.: 044-28172096, 28170527  
E-Mail: in-chennai-office@indoasian.com

#### Branch office

#### HYDERABAD

312, 3rd Floor,  
Amrutha Estates, Himayath Nagar,  
Hyderabad-500029  
Ph.: 040-66742425  
E-Mail: in-secunderabad-office@indoasian.com

### WEST

#### Regional Sales office

#### MUMBAI

401 & 408, K.P. Arrum,  
Marol Morshi Road, Andheri East,  
Mumbai-400059  
Ph.: 022-61035800  
E-Mail: in-mumbai-office@indoasian.com

#### Branch office

#### AHMEDABAD

102, 1st Floor, Shivalik High Street,  
Near Mansi Circle, Vastrapur,  
Ahmedabad-380015  
Ph.: 079-29701351-53  
E-Mail: in-ahmedabad-office@indoasian.com

#### Branch office

#### INDORE

202, KK Bafna Arcade,  
Janjeerwala Square,  
Race Course Road,  
Indore-452001  
Ph.: 0731-4064064  
E-Mail: in-indore-office@indoasian.com

#### Branch office

#### PUNE

311, Pride Silicon Plaza,  
Bhamburda, Shivaji Nagar,  
Senapati Bapat Marg,  
Pune-411016  
Ph.: 8087610722  
E-Mail: in-pune-office@indoasian.com

### EAST

#### Regional Sales office

#### KOLKATA

"Raikva Building" Room No. 8, 2nd Floor,  
3A Ram Mohan Garden Lane,  
Beliaghata E.M.Bypass, Kolkata-700010  
Ph.: 033-66041503  
E-Mail: in-kolkata-office@indoasian.com

IAIRetail Price List/06-201/0000